

CHAPTER 1



INTRODUCTION

1.1.	Project Development Steps	1
1.2.	Using the Software.....	2
1.2.1.	Main Menus	2
1.2.2.	Toolbars	14
1.2.3.	Project Manager.....	22
1.2.4.	Screen Manager	30
1.2.5.	Pop-up Menus.....	32

1.1. Project Development Steps

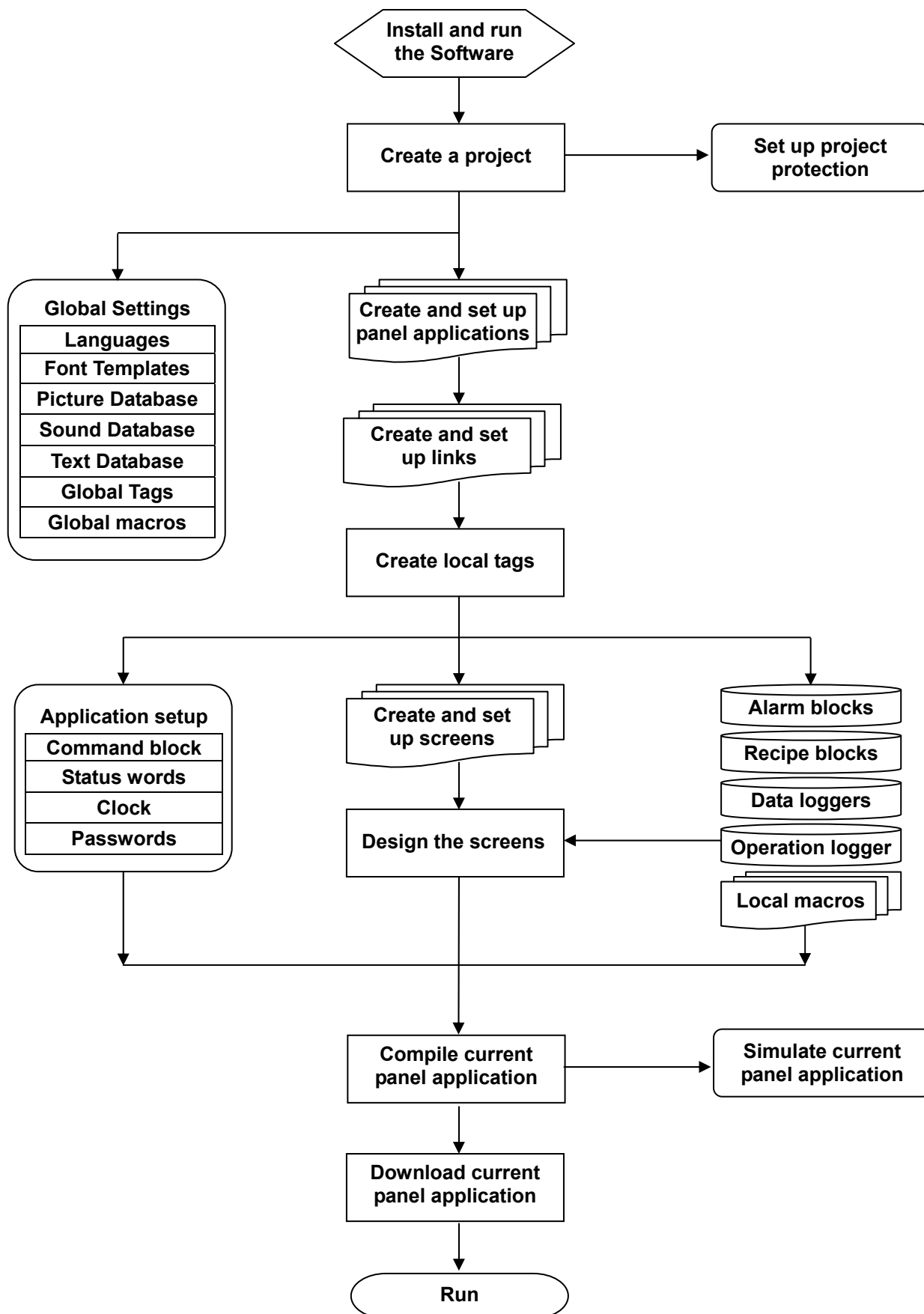



1.2. Using the Software







1.2.1. Main Menus

There are 11 drop down menus you can select in the main menu: File, Edit, View, Screen, Draw, Object, Project, Panel, Tools, Window, Help.

















1.2.1.1. File Menu

Icon	Menu Item	Shortcut	Description
	New	Ctrl+N	Create a new project.
	Open...	Ctrl+O	Open an existing project.
	Close		Close the current project.
	Save	Ctrl+S	Save the current project.
	Save As...		Save the current project with a new name.
	<Recently opened filename>		Open the referred project.
	Exit		Exit the software.





1.2.1.2. Edit Menu

Icon	Menu Item	Pop-up Menu Item	Shortcut	Description
	Undo		Ctrl+Z	Undo the last action.
	Redo		Ctrl+Y	Redo the previously undone action.
	Cut		Ctrl+X	Cut the selection and put it on the Clipboard.
	Copy		Ctrl+C	Copy the selection and put it on the Clipboard.
	Paste		Ctrl+V	Place the Clipboard contents on the current screen.
	Delete		Del	Delete the selection.
	Duplicate...			Duplicate the selected object.
	Find and Replace	Find...		Find the specified text.
		Replace...		Replace specific text with different text.
	Show Grid			Show or hide the grid.
	Snap to Grid			Select or deselect the option of aligning objects to the grid points.
	Grid Settings...			Opens the Grid Settings dialog box.
	Select All		Ctrl+A	Select entire objects of the active screen.
	Group			Group the selection.
	Ungroup			Ungroup the selected group.

Continued

Icon	Menu Item	Pop-up Menu Item	Description
	Pin		Pin the selection so it cannot move.
	Unpin		Unpin the selection so it can move again.
	Auto Text Resizing		Select or deselect the option of automatic text resizing.
	Align	Left	Align the left sides of selected objects to the left side of the reference object. All the objects move horizontally so their left sides are in line with the left side of the reference object.
		Vertical Center	Align the vertical centers of selected objects to the vertical center of the reference object. All the objects move horizontally so their vertical centers are in line with the vertical center of the reference object.
		Right	Align the right sides of selected objects to the right side of the reference object. All the objects move horizontally so their right sides are in line with the right side of the reference object.
		Top	Align the tops of the selected objects to the top of the reference object. All the objects move vertically so their tops are in line with the top of the reference object.
		Horizontal Center	Align the horizontal centers of selected objects to the horizontal center of the reference object. All the objects move vertically so their horizontal centers are in line with the horizontal center of the reference object.
		Bottom	Align the bottoms of selected objects to the bottom of the reference object. All the objects move vertically so their bottoms are in line with the bottom of the reference object.
		To Grid	Select or deselect the option of aligning objects to the grid points.
		Make Same Size	Width
	Height		Make the selected objects have the same height as the reference object.
	Both		Make the selected objects have the same width and height as the reference object.
	Nudge	Left	Nudge the selection left. When the Snap to Grid option is not selected, all objects of the selection move one pixel left. When the Snap to Grid option is selected, each object of the selection moves left to where its upper-left corner aligns to the nearest grid point.
		Right	Nudge the selection right. When the Snap to Grid option is not selected, all objects of the selection move one pixel right. When the Snap to Grid option is selected, each object of the selection moves right to where its upper-left corner aligns to the nearest grid point.
		Up	Nudge the selection up. When the Snap to Grid option is not selected, all objects of the selection move one pixel up. When the Snap to Grid option is selected, each object of the selection moves up to where its upper-left corner aligns to the nearest grid point.
		Down	Nudge the selection down. When the Snap to Grid option is not selected, all objects of the selection move one pixel down. When the Snap to Grid option is selected, each object of the selection moves down to where its upper-left corner aligns to the nearest grid point.

Continued

Icon	Menu Item	Pop-up Menu Item	Description
	Layer	Bring to Top	Bring the selection to the top.
		Bring Forward	Bring the selected object one layer up.
		Send Backward	Send the selected object one layer down.
		Send to Bottom	Send the selection to the bottom.
	Set Order		Start the order setting process for the objects of the active screen.
	Object Properties...		Open the property sheet of the selected object.
	Save as Default		Save the selected object as the default object for the type of that object. Default objects are saved in the Objects category of the object library.
	Save to Object Library...		Save the selected object to the object library.
	Save as Global Object...		Save the selected object as the global object which is saved in the Global category of the object library. Global Objects can be used for the Global Object Containers.

Note:

1. To select a reference object from the selection, use [Ctrl+Click].
2. To add an object to the selection, use [Shift+Click].



1.2.1.3. View Menu

Icon	Menu Item	Pop-up Menu Item	Description
	Address	Write/Monitor	Display the Write address and Monitor address defined for each object of all the opened screens.
		Write	Display the Write address defined for each object of all the opened screens.
		Monitor	Display the Monitor address defined for each object of all the opened screens.
		Read	Display the Read address defined for each object of all the opened screens.
		Notification	Display the Notification address defined for each object of all the opened screens.
		Touch Operation Control	Display the address of the Touch Operation Control bit defined for each object of all the opened screens.
		Visibility Control	Display the address of the Visibility Control bit defined for each object of all the opened screens.
	Show Tips		Select or deselect the option of displaying tip for the toolbar icon or the object on which the cursor stays.

















Continued

Icon	Menu Item	Pop-up Menu Item	Description
	Zoom	25%	Display screens in 25% of their normal sizes.
		50%	Display screens in 50% of their normal sizes.
		70%	Display screens in 70% of their normal sizes.
		80%	Display screens in 80% of their normal sizes.
		90%	Display screens in 90% of their normal sizes.
		100%	Display screens in normal size.
		150%	Display screens in 150% of their normal sizes.
		200%	Display screens in 200% of their normal sizes.
		300%	Display screens in 300% of their normal sizes.
	Normal Size		Display screens in normal size.
	Project Manager		Show or hide Project Manager.
	Screen Manager		Show or hide Screen Manager.
	Screen Overview		Show or hide Screen Overview.
	Link Overview		Show or hide Link Overview.
	Object Library		Show or hide Object Library.
	Macro Command Properties		Show or hide Macro Command Properties window.
	Object List		Show or hide Object List.
	I/O List		Show or hide I/O List.
	Standard Toolbar		Show or hide Standard toolbar.
	Object Toolbar		Show or hide Object toolbar.
	Draw Toolbar		Show or hide Draw toolbar.
	Text Toolbar		Show or hide Text toolbar.
	Edit Toolbar		Show or hide Edit toolbar.
	Address Toolbar		Show or hide Address toolbar.
	Picture Toolbar		Show or hide Picture toolbar.
	Status Bar		Show or hide Status bar.
	Semi-transparent Object Dialog View		Select or deselect the option of displaying the object property dialog box in semi-transparent mode. A semi-transparent dialog box allows you to see the objects underlying the dialog box.
	<Language name>		Display the text of objects in the selected language.





1.2.1.4. Screen Menu

Icon	Menu Item	Description
	New Screen...	Create a new screen for the current panel application.
	Open Screen...	Open an existing screen of the current panel application.
	Close Screen	Close the current screen.
	Close All Screens	Close all the opened screens.
	Cut Screen	Cut the current screen and put it on the Clipboard.
	Copy Screen	Copy the current screen and put it on the Clipboard.
	Paste Screen	Insert the screen on the Clipboard to the current panel application.
	Delete Screen	Delete the current screen.
	Stretch Screen...	Stretch the current screen.
	Export Screen...	Export the current screen to a file.
	Import Screen...	Import a screen from a file for the current panel application.
	Save Current Screen as Picture...	Save the current screen to a picture file.
	Save Screens as Pictures...	Open the Save Screens as Pictures dialog box. You can save each of the selected screens to a picture file using the dialog box.
	Screen Properties	Open the screen property dialog box for the current screen.























1.2.1.5. Draw Menu

Icon	Menu Item	Description
	Dot	Get ready to place a copy of the default dot on a screen.
	Line	Get ready to place a copy of the default line on a screen.
	Horizontal Line	Get ready to place a copy of the default horizontal line on a screen.
	Vertical Line	Get ready to place a copy of the default vertical line on a screen.
	Polyline	Get ready to draw a polyline on a screen.
	Rectangle	Get ready to place a copy of the default rectangle on a screen.
	Round Rectangle	Get ready to place a copy of the default round rectangle on a screen.
	Clipped Rectangle	Get ready to place a copy of the default clipped rectangle on a screen.
	Circle	Get ready to place a copy of the default circle on a screen.
	Ellipse	Get ready to place a copy of the default ellipse on a screen.
	Arc	Get ready to place a copy of the default arc on a screen.
	Pie	Get ready to place a copy of the default pie shape on a screen.
	Polygon	Get ready to draw a polygon on a screen.
	Text	Get ready to place a copy of the default text object on a screen.
	Picture	Get ready to place a copy of the default picture object on a screen.
	Scale	Get ready to place a copy of the default scale on a screen.
	Table	Get ready to place a copy of the default table on a screen.







1.2.1.6. Object Menu

Icon	Menu Item	Pop-up Menu Item	Description
	Bit Button		Get ready to place a copy of the default bit button on a screen.
	Toggle Switch		Get ready to place a copy of the default toggle switch on a screen.
	Screen Button		Get ready to place a copy of the default screen button on a screen.
	Function Button		Get ready to place a copy of the default function button on a screen.
	Slide Switch		Get ready to place a copy of the default slide switch on a screen.
	More buttons	Word Button	Get ready to place a copy of the default word button on a screen.
		Multistate Switch	Get ready to place a copy of the default multistate Switch on a screen.
		Radio Button Group	Get ready to place a copy of the default radio button group on a screen.
		Keypad Button	Get ready to place a copy of the default keypad button on a screen.
		Scroll Button Group	Get ready to place a copy of the default scroll button group on a screen.
		Scroll Bar	Get ready to place a copy of the default scroll bar on a screen.
		Step Button	Get ready to place a copy of the default step button on a screen.
		Page Selector	Get ready to place a copy of the default page selector on a screen.
	Numeric Entry		Get ready to place a copy of the default numeric entry on a screen.
	Numeric Display		Get ready to place a copy of the default numeric display on a screen.
	Advanced Numeric Display		Get ready to place a copy of the default advanced numeric display on a screen.
	Character Entry		Get ready to place a copy of the default ASCII string entry on a screen.
	Character Display		Get ready to place a copy of the default ASCII string display on a screen.
	Bit Lamp		Get ready to place a copy of the default bit lamp on a screen.
	Multistate Lamp		Get ready to place a copy of the default multistate lamp on a screen.
	Message Display		Get ready to place a copy of the default message display on a screen.
	Time/Date	Time Display	Get ready to place a copy of the default time display on a screen.
		Date Display	Get ready to place a copy of the default date display on a screen.
		Day-of-week Display	Get ready to place a copy of the default day-of-week display on a screen.

Continued

Icon	Menu Item	Pop-up Menu Item	Description
	Meter		Get ready to place a copy of the default meter on a screen.
	Dynamic Graphic	Dynamic Circle	Get ready to place a copy of the default dynamic circle on a screen.
		Dynamic Rectangle	Get ready to place a copy of the default dynamic rectangle on a screen.
		GIF Display	Get ready to place a copy of the default GIF display on a screen.
		Picture Display	Get ready to place a copy of the default picture display on a screen.
		Animated Graphic	Get ready to place a copy of the default animated graphic on a screen.
	Pipeline		Get ready to place a copy of the default pipeline on a screen.
	Graph/Chart	Bar Graph	Get ready to place a copy of the default bar graph on a screen.
		Line Chart	Get ready to place a copy of the default line chart on a screen.
		Circular Bar Graph	Get ready to place a copy of the default circular bar graph on a screen.
		Scatter Chart	Get ready to place a copy of the default scatter chart on a screen.
	Alarm Display		Get ready to place a copy of the default alarm display on a screen.
	Historic Display	Historic Data Table	Get ready to place a copy of the default historic data table on a screen.
		Historic Event Table	Get ready to place a copy of the default historic event table on a screen.
		Historic Trend Graph	Get ready to place a copy of the default historic trend graph on a screen.
		Single Record Line Chart	Get ready to place a copy of the default single record line chart on a screen.
		Operation Log Display	Get ready to place a copy of the default operation log display on a screen.
	Recipe Selector		Get ready to place a copy of the default recipe selector on a screen.
	Recipe Table		Get ready to place a copy of the default recipe table on a screen.
	Sublink Table		Get ready to place a copy of the default sublink table on a screen.
	Schedule Setting Table		Get ready to place a copy of the default schedule setting table on a screen.
	Screen Window		Get ready to place a copy of the default screen window on a screen.
	Global Object Container		Get ready to place a copy of the default global object container on a screen.
	USB Camera View		Get ready to place a copy of the default USB camera view on a screen.

1.2.1.7. Project Menu

Icon	Menu Item	Pop-up Menu Item	Description
	Information & Protection...		Open the Project Information & Protection dialog box. This dialog box shows the basic information of your project and allows you to define how to protect it.
	Languages...		Open the Languages dialog box. You can specify up to 10 languages for your project to support with this dialog box.
	Font Templates...		Open the Font Templates dialog box. With this dialog box, you can specify up to 20 fonts as the frequently used fonts for each language.
	Picture Database...		Open the Picture Database (dialog box). You can import pictures and organize them for your project in this dialog box.
	Sound Database...		Open the Sound Database (dialog box). You can import sounds for your project in this dialog box.
	Text Database...		Open the Text Database (dockable window). With Text Database, you can import text, export text, and edit text for your project.
	Global Tags...		Open the Global Tags window. You can define the global tags in this window.
	Global Macro	Add...	Create a new macro.
		Edit	Select a macro to edit.
		Delete	Select a macro to delete.
	Add New Panel Application...		Create a new panel application.
	Import Panel Application...		Import a panel application from a PLF file.
	Delete Panel Application		Select a panel application to delete.

1.2.1.8. Panel Menu

Icon	Menu Item	Pop-up Menu Item	Description
	Current Panel Application	<Panel application name>	Select a panel application as the current application
	Link	Add...	Add a new communication link to the current application.
		Properties	Select a communication link to open its property sheet.
		Delete	Select a communication link to delete.
		Driver List...	Open communication driver list dialog box which lists all the supported communication drivers. In the dialog box, you can export the driver list to the .csv file.
	Tags...		Open the Tags window of the current application. You can define tags for the application in this window.
	Sound Table...		Open the Sound Table (dialog box). You can collect sounds for the current application in this dialog box.
	General Setup...		Open the Panel General Setup dialog box. You can define the general settings for the current application in this dialog box.
	Command & Status...		Open the Command & Status dialog box. You can define the command block and the status words for the current application in this dialog box.
	Clock...		Open the Clock dialog box. You can define the clock operations for the current application in this dialog box.
	Passwords...		Open the Passwords dialog box. You can define passwords and related settings for the application in this dialog box.
	Discrete Alarm Block	Add	Add a new discrete alarm block to the current application.
		Properties	Select a discrete alarm block to open its property sheet.
		Delete	Select a discrete alarm block to delete.
	Analog Alarm Block	Add	Add a new analog alarm block to the current application.
		Properties	Select an analog alarm block to open its property sheet.
		Delete	Select an analog alarm block to delete.
	Recipe Block	Add	Add a new recipe block to the current application.
		Properties	Select a recipe block to open its property sheet.
		Delete	Select a recipe block to delete.
	Data Logger	Add	Add a new data logger to the current application.
		Properties	Select a data logger to open its property sheet.
		Delete	Select a data logger to delete.
	Operation Logging...		Open the Operation Logging dialog box. You can define the settings of operation logging for the current application in this dialog box.
	Schedule...		Open the Schedule dialog box. You can define schedules and related settings for the application in this dialog box.
	Macro	Add...	Add a new macro to the current application.
		Edit	Select a macro of the current application to edit.
		Delete	Select a macro of the current application to delete.
	Compile...		Compile the current application to build the runtime data. You can download the runtime data to the target panel. With the runtime data the target panel can perform exactly what you programmed for the application.

Continued

Icon	Menu Item	Pop-up Menu Item	Description
	Build Panel Runtime Package (PRP)...		Build the panel runtime package (PRP) file for the current application. The PRP file contains the runtime data and the system programs. You can update the target panel without the project file by downloading the PRP file to it. The target panel can also update itself by loading the PRP file from a USB mass storage device.
	Build ROM Image...		Build the ROM image file for the current application. The ROM image file contains the runtime data and the system programs. The target panel can update itself by loading the ROM image file from a micro SD card.
	Download...		Download data to the target panel.
	Upload...		Upload data from the target panel.
	Export Panel Application...		Export the current panel application to a PLF file.

1.2.1.9. Tools Menu

Icon	Menu Item	Pop-up Menu Item	Description								
	Language Selection	Auto	When this item is selected: <table border="1" data-bbox="767 947 1509 1160"> <thead> <tr> <th>Default Language for the Windows</th> <th>Language Used for the U/I of the software</th> </tr> </thead> <tbody> <tr> <td>Simplified Chinese</td> <td>Simplified Chinese</td> </tr> <tr> <td>Traditional Chinese</td> <td>Traditional Chinese</td> </tr> <tr> <td>Others</td> <td>English</td> </tr> </tbody> </table>	Default Language for the Windows	Language Used for the U/I of the software	Simplified Chinese	Simplified Chinese	Traditional Chinese	Traditional Chinese	Others	English
Default Language for the Windows		Language Used for the U/I of the software									
Simplified Chinese		Simplified Chinese									
Traditional Chinese		Traditional Chinese									
Others	English										
	English	Select English as the language for the U/I of the software.									
	Chinese (Simplified)	Select simplified Chinese as the language for the U/I of the software.									
	Chinese (Traditional)	Select traditional Chinese as the language for the U/I of the software.									
	Run Offline Simulation		Run offline simulation for the current application.								
	Run Online Simulation		Run online simulation for the current application.								
	Set Transparent Communication...		Open the Set Transparent Communication dialog box.								
	Start Transparent Communication		Start the transparent communication.								
	End Transparent Communication		End the transparent communication.								
	Update OS0 through BIOS		Update the system program OS0 of the target panel through its BIOS. This operation is useful when the system programs of the target panel were destroyed.								
	Export Text...		Export the text of the current application to a PTX file.								
	Import Text...		Import the text in a PTX file for the selected application.								
	TextEditor		Run the TextEditor program to edit the text of a PTX file.								

1.2.1.10. Window Menu

Icon	Menu Item	Description
	Cascade	Arrange windows so they overlap.
	Tile Vertical	Arrange windows as non-overlapping vertical tiles.
	Tile Horizontal	Arrange windows as non-overlapping horizontal tiles.
	Arrange Icon	Arrange icons at the bottom of the window.
	Restore	Restore the windows to their original sizes and positions.
	Maximize	Maximize the windows
	Opened Window List	Display a list of opened windows titles. You may click the window title to bring the corresponding window to the top.
	Windows...	Open the Windows dialog box to activate or save or close the selected window.

1.2.1.11. Help Sub-menu

Icon	Menu Item	Description
	About...	Open the About... dialog box. You can see the version number of the software in this dialog box.

1.2.2. Toolbars

1.2.2.1. Standard Toolbar



Icon	Tool Tip	Description
	New	Create a new project.
	Open	Open an existing project.
	Save	Save the current project.
	Cut	Cut the selection and put it on the Clipboard.
	Copy	Copy the selection and put it on the Clipboard.
	Paste	Place the Clipboard contents on the current screen.
	Undo	Undo the last edit action.
	Redo	Redo the previously undone edit action.
	New Screen	Create a new screen for the current panel application.
	Screen Properties	Open the screen property dialog box for the current screen.
	Previous Screen	Open the previous screen in terms of screen number.
	Next Screen	Open the next screen in terms of screen number.
	Zoom In	Make the screen view one step bigger.
	Zoom Out	Make the screen view one step smaller.
	Normal Size	Restore the screen view to normal size.
	Off (State 0)	Show the Off state of all the objects on the current screen.
	On (State 1)	Show the On state of all the objects on the current screen.
	State	Select a state for the selected object to show.
	Compile	Compile the current application to build the runtime data. You can download the runtime data to the target panel. With the runtime data, the target panel performs exactly like how the application was programmed.
	Download	Download data to the target panel.
	Download Immediately	Download data using the existing settings to the target panel immediately
	Run Offline Simulation	Run offline simulation for the current application.
	About	Open the About dialog box.

1.2.2.2. Object Toolbar



Icon	Tool Tip	Description
	Bit Button	Get ready to place a copy of the default bit button on a screen.
	Word Button	Get ready to place a copy of the default word button on a screen.
	Screen Button	Get ready to place a copy of the default screen button on a screen.
	Page Selector	Get ready to place a copy of the default page selector on a screen.
	Function Button	Get ready to place a copy of the default function button on a screen.
	Keypad Button	Get ready to place a copy of the default keypad button on a screen.
	Scroll Button Group	Get ready to place a copy of the default scroll button group on a screen.
	Scroll Bar	Get ready to place a copy of the default scroll bar on a screen.
	Radio Button Group	Get ready to place a copy of the default radio button group on a screen.
	Step Button	Get ready to place a copy of the default step button on a screen.
	Toggle Switch	Get ready to place a copy of the default toggle switch on a screen.
	Multistate Switch	Get ready to place a copy of the default multistate switch on a screen.
	Slide Switch	Get ready to place a copy of the default slide switch on a screen.
	Numeric Entry	Get ready to place a copy of the default numeric entry on a screen.
	ASCII String Entry	Get ready to place a copy of the default ASCII string entry on a screen.
	Advanced Numeric Display	Get ready to place a copy of the default advanced numeric display on a screen.
	Bit Lamp	Get ready to place a copy of the default bit lamp on a screen.
	Multistate Lamp	Get ready to place a copy of the default multistate lamp on a screen.
	Numeric Display	Get ready to place a copy of the default numeric display on a screen.
	ASCII String Display	Get ready to place a copy of the default ASCII string display on a screen.
	Message Display	Get ready to place a copy of the default message display on a screen.
	Meter	Get ready to place a copy of the default meter on a screen.

Continued

Icon	Tool Tip	Description
	Time Display	Get ready to place a copy of the default time display on a screen.
	Date Display	Get ready to place a copy of the default date display on a screen.
	Day-of-week Display	Get ready to place a copy of the default day-of-week display on a screen.
	Dynamic Circle	Get ready to place a copy of the default dynamic circle on a screen.
	Dynamic Rectangle	Get ready to place a copy of the default dynamic rectangle on a screen.
	GIF Display	Get ready to place a copy of the default GIF display on a screen.
	Picture Display	Get ready to place a copy of the default picture display on a screen.
	Animated Graphic	Get ready to place a copy of the default animated graphic on a screen.
	Pipeline	Get ready to place a copy of the default pipeline on a screen.
	Bar Graph	Get ready to place a copy of the default bar graph on a screen.
	Line Chart	Get ready to place a copy of the default line chart on a screen.
	Circular Bar Graph	Get ready to place a copy of the default circular bar graph on a screen.
	Scatter Chart	Get ready to place a copy of the default scatter chart on a screen.
	Alarm Display	Get ready to place a copy of the default alarm display on a screen.
	Historic Data Table	Get ready to place a copy of the default historic data table on a screen.
	Historic Event Table	Get ready to place a copy of the default historic event table on a screen.
	Historic Trend Graph	Get ready to place a copy of the default historic trend graph on a screen.
	Single Record Line Chart	Get ready to place a copy of the default single record line chart on a screen.
	Operation Log Display	Get ready to place a copy of the default operation log display on a screen.
	Recipe Selector	Get ready to place a copy of the default recipe selector on a screen.
	Recipe Table	Get ready to place a copy of the default recipe table on a screen.
	Sublink Table	Get ready to place a copy of the default sublink table on a screen.
	Schedule Setting Table	Get ready to place a copy of the default schedule setting table on a screen.
	Screen Window	Get ready to place a copy of the default screen window on a screen.
	USB Camera View	Get ready to place a copy of the default USB camera view on a screen.

1.2.2.3. Draw Toolbar



Icon	Tool Tip	Description
	Dot	Get ready to place a copy of the default dot on a screen.
	Line	Get ready to place a copy of the default line on a screen.
	Horizontal Line	Get ready to place a copy of the default horizontal line on a screen.
	Vertical Line	Get ready to place a copy of the default vertical line on a screen.
	Polyline	Get ready to draw a polyline on a screen.
	Rectangle	Get ready to place a copy of the default rectangle on a screen.
	Round Rectangle	Get ready to place a copy of the default round rectangle on a screen.
	Clipped Rectangle	Get ready to place a copy of the default clipped rectangle on a screen.
	Polygon	Get ready to draw a polygon on a screen.
	Circle	Get ready to place a copy of the default circle on a screen.
	Ellipse	Get ready to place a copy of the default ellipse on a screen.
	Arc	Get ready to place a copy of the default arc on a screen.
	Pie	Get ready to place a copy of the default pie shape on a screen.
	Table	Get ready to place a copy of the default table on a screen.
	Scale	Get ready to place a copy of the default scale on a screen.
	Text	Get ready to place a copy of the default text object on a screen.
	Picture	Get ready to place a copy of the default picture object on a screen.
	Dot Style	Select a dot style for the selected dot.
	Line Style	Select a line style for the selected shape.
	Border Color	Select a color for the border of the selected shape.
	BG Color	Select a color for the background of the selected solid shape.
	Pattern Style	Select a pattern for the selected solid shape.
	FG/Pattern Color	Select a color for the pattern of the selected solid shape.















1.2.2.4. Text Toolbar











Icon	Tool Tip	Description						
	Text Type	Select the type of text you are working on. <table border="1"> <thead> <tr> <th>Text Type</th> <th>Description</th> </tr> </thead> <tbody> <tr> <td>Inner Text</td> <td>Text displayed inside of an object.</td> </tr> <tr> <td>External Text</td> <td>Text of the external label of an object.</td> </tr> </tbody> </table>	Text Type	Description	Inner Text	Text displayed inside of an object.	External Text	Text of the external label of an object.
Text Type	Description							
Inner Text	Text displayed inside of an object.							
External Text	Text of the external label of an object.							
	Language	Select a language that you are defining the text for.						
	Font	Select a font for the text.						
	Size	Select a font size for the text.						
	Text	Edit the text. Click to select the text from text database.						
	Text	Select the text from the text database. Click to edit text.						
	Text Color	Select a color for the text.						
	Background Color	Select a color for the background of the object.						
	Center Position	Position the text at the center within the object.						
	Horizontal Position	Change the horizontal position of the text within the object.						
	Vertical Position	Change the vertical position of the text within the object.						
	Align Left	Align the text to the left of the text body.						
	Center	Align the text to the center of the text body						
	Align Right	Align the text to the right of the text body						
	External Label Position	Change the position of the external label.						

1.2.2.5. Edit Toolbar





Icon	Tool Tip	Description
	Align Left	Align the left sides of selected objects to the left side of the reference object. All the objects move horizontally so their left sides are in line with the left side of the reference object.
	Align Vertical Center	Align the vertical centers of selected objects to the vertical center of the reference object. All the objects move horizontally so their vertical centers are in line with the vertical center of the reference object.
	Align Right	Align the right sides of selected objects to the right side of the reference object. All the objects move horizontally so their right sides are in line with the right side of the reference object.
	Align Top	Align the tops of the selected objects to the top of the reference object. All the objects move vertically so their tops are in line with the top of the reference object.
	Align Horizontal Center	Align the horizontal centers of selected objects to the horizontal center of the reference object. All the objects move vertically so their horizontal centers are in line with the horizontal center of the reference object.
	Align Bottom	Align the bottoms of selected objects to the bottom of the reference object. All the objects move vertically so their bottoms are in line with the bottom of the reference object.
	Snap to Grid	Select or deselect the option of aligning objects to the grid points.
	Make Same Width	Make the selected objects have the same width as the reference object.
	Make Same Height	Make the selected objects have the same height as the reference object.
	Make Same Size	Make the selected objects have the same width and height as the reference object.
	Nudge Left	Nudge the selection left. When the Snap to Grid option is not selected, all objects of the selection move one pixel left. When the Snap to Grid option is selected, each object of the selection moves left to where its upper-left corner aligns to the nearest grid point.
	Nudge Right	Nudge the selection right. When the Snap to Grid option is not selected, all objects of the selection move one pixel right. When the Snap to Grid option is selected, each object of the selection moves right to where its upper-left corner aligns to the nearest grid point.
	Nudge Up	Nudge the selection up. When the Snap to Grid option is not selected, all objects of the selection move one pixel up. When the Snap to Grid option is selected, each object of the selection moves up to where its upper-left corner aligns to the nearest grid point.
	Nudge Down	Nudge the selection down. When the Snap to Grid option is not selected, all objects of the selection move one pixel down. When the Snap to Grid option is selected, each object of the selection moves down to where its upper-left corner aligns to the nearest grid point.

Continued

Icon	Tool Tip	Description
	Bring to Top	Bring the selection to the top.
	Bring Forward	Bring the selected object one layer up.
	Send Backward	Send the selected object one layer down.
	Send to Bottom	Send the selection to the bottom.
	Group	Group the selection.
	Ungroup	Ungroup the selected group.
	Pin	Pin the selection so it cannot move.
	Unpin	Unpin the selection so it can move again.
	Auto Text Resizing	Select or deselect the option of automatic text resizing.

1.2.2.6. Address Toolbar

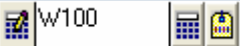

Icon	Tool Tip	Description
	Write Address	Specifies the Write address of the selected object.
	Read Address	Specifies the Read address of the selected object.
	Monitor Address	Specifies the Monitor address of the selected object.

1.2.2.7. Picture Toolbar

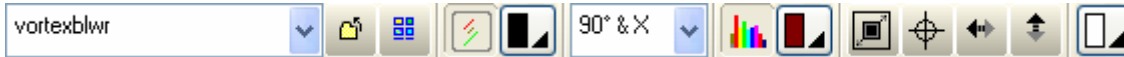

Icon	Tool Tip	Description
	Picture Name	Specifies the picture name. You can select an imported picture here using the drop-down list.
	Import from File	Select a picture from a picture file.
	Select/Import from Library	Select a picture from the software provided picture library.
	Transparent	Select or deselect the option that parts of the picture are transparent. The transparent parts are pixels having the specified transparent color.
	Transparent Color	Select a color as the transparent color.
	Flip/Rotate	Select a method to rotate/flip the picture.
	Tone	Select or deselect the option that the picture is toned with the specified toning color.
	Toning Color	Select a color as the toning color.
	Fit to Object	Stretch the picture so it has the same size as the object.
	Center	Position the picture at the center location within the object.
	Horizontal Position	Change the horizontal position of the picture within the object.
	Vertical Position	Change the vertical position of the picture within the object.
	Background Color	Select a color for the background of the object.

1.2.2.8. Status Bar

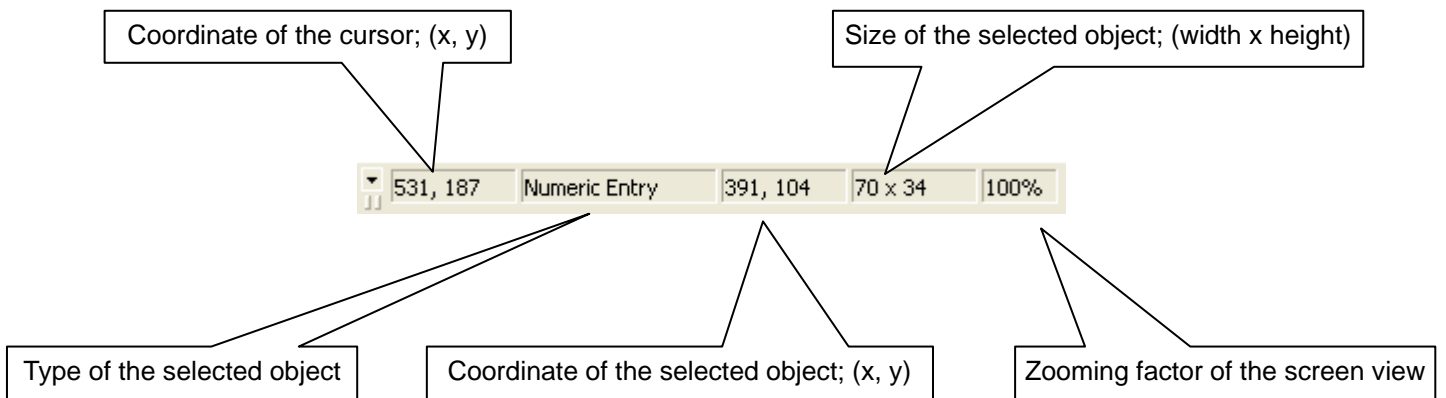

1.2.3. Project Manager

The Project Manager is a dockable window with a project tree. You can manage your project with it easily. To open the Project Manager, check the Project Manager menu item in the View menu. The following is an example of the Project Manager. In this example, the project MyProject has two panel applications: MyAP_1 and MyAp_2.

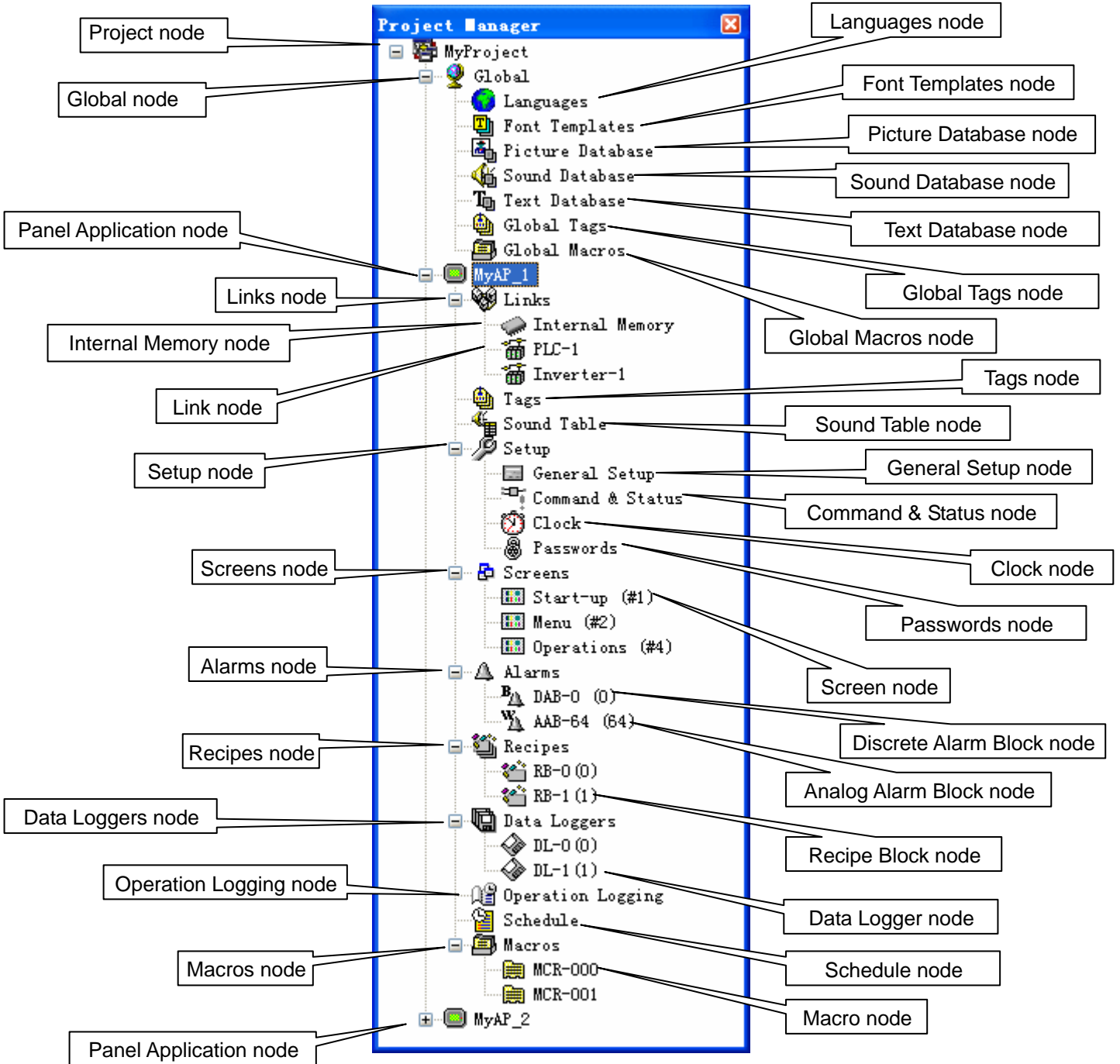

■ Project Node ()

The label of the Project node is the project name. You can do the following with the Project node:

- 1) Double-click it to open the Project Information & Protection dialog box.
- 2) Right-click it to get a pop-up menu with the following menu items:

Menu Item	Description
Add Panel Application...	Create a new panel application.
Import Panel Application...	Import a panel application from a PLF file.
Information	Open the Project Information & Protection dialog box.
Toggle All	Expand all the collapsed lists of sub-nodes and collapse all the expanded lists of sub-nodes.

■ Global Node ()

The Global node has seven sub-nodes. You can do the following with the Global node:

- 1) Double-click it to expand or collapse the list of its sub-nodes.

■ Languages Node ()

You can do the following with the Languages node:

- 1) Double-click it to open the Languages dialog box.
- 2) Right-click it to get a pop-up menu with the following menu item:

Menu Item	Description
Properties...	Open the Languages dialog box.

■ Font Templates Node ()

You can do the following with the Font Templates node:

- 1) Double-click it to open the Font Templates dialog box.
- 2) Right-click it to get a pop-up menu with the following menu item:

Menu Item	Description
Properties...	Open the Font Templates dialog box.

■ Picture Database Node ()

You can do the following with the Picture Database node:

- 1) Double-click it to open the Picture Database dialog box.
- 2) Right-click it to get a pop-up menu with the following menu item:

Menu Item	Description
Properties...	Open the Picture Database dialog box.

■ Sound Database Node ()

You can do the following with the Sound Database node:

- 1) Double-click it to open the Sound Database dialog box.
- 2) Right-click it to get a pop-up menu with the following menu item:

Menu Item	Description
Properties...	Open the Sound Database dialog box.

■ Text Database Node ()

You can do the following with the Text Database node:

- 1) Double-click it to open the Text Database dialog box.
- 2) Right-click it to get a pop-up menu with the following menu item:

Menu Item	Description
Open	Open the Text Database window.

■ Global Tags Node ()

You can do the following with the Global Tags node:

- 1) Double-click it to open the Global Tags window.
- 2) Right-click it to get a pop-up menu with the following menu item:

Menu Item	Description
Open	Open the Global Tags window.

■ Global Macros Node ()

The Global Macros node can have many Global Macro sub-nodes. Each Global Macro node is associated with a global macro of the project. You can do the following with the Global Macros node:

- 1) Double-click it to expand or collapse the list of its sub-nodes.
- 2) Right-click it to get a pop-up menu with the following menu items.

Menu Item	Description
Add Macro...	Create a new global macro.
Import Macro...	Import a global macro from an MCR file.

■ Global Macro Node ()

Each Global Macro node is associated with a global macro of the project. You can do the following with the Global Macro node:

- 1) Double-click it to open the editing window of the associated macro.
- 2) Right-click it to get a pop-up menu with the following menu items.

Menu Item	Description
Open	Open the editing window of the associated macro.
Close	Close the editing window of the associated macro.
Rename	Rename the associated macro.
Delete	Delete the associated macro.
Export Macro...	Export the associated macro to an MCR file.

■ Panel Application Node ()

The label of a Panel Application node is the associated application name. You can do the following with the Panel Application node:

- 1) Double-click it to open the General Setup dialog box.
- 2) Right-click it to get a pop-up menu with the following menu items:

Menu Item	Description
Rename	Rename the panel application.
Delete	Delete the panel application.
General Setup	Open the General Setup dialog box.
Export Panel Application...	Export the panel application to a PLF file.
Toggle All	Expand all the collapsed lists of sub-nodes and collapse all the expanded lists of sub-nodes.

■ Links Node ()

The Links node has one Internal Memory sub-node and can have up to 16 Link sub-nodes. You can do the following with the Links node:

- 1) Double-click it to expand or collapse the list of its sub-nodes.
- 2) Right-click it to get a pop-up menu with the following menu item:

Menu Item	Description
Add Link	Create a new communication link.
Driver Link...	Open communication driver list dialog box which lists all the supported communication drivers. In the dialog box, you can export the driver list to the .csv file.

■ Internal Memory Node ()

You can do the following with the Internal Memory node:

- 1) Double-click it to open the Internal Memory dialog box.
- 2) Right-click it to get a pop-up menu with the following menu item:

Menu Item	Description
Properties...	Open the Internal Memory dialog box.

■ Link Node ()

A Link node is associated with a communication link. You can do the following with the Link node:

- 1) Double-click it to open the Link Properties dialog box of the associated communication link.
- 2) Right-click it to get a pop-up menu with the following menu item:

Menu Item	Description
Rename	Rename the associated communication link.
Delete	Delete the associated communication link.
Properties...	Open the Link Properties dialog box of the associated communication link.

■ Tags Node ()

You can do the following with the Tags node:

- 1) Double-click it to open the Tags window.
- 2) Right-click it to get a pop-up menu with the following menu item:

Menu Item	Description
Open	Open the Tags window.

■ Sound Table Node ()

You can do the following with the Sound Table node:

- 1) Double-click it to open the Sound Table dialog box.
- 2) Right-click it to get a pop-up menu with the following menu item:

Menu Item	Description
Properties...	Open the Sound Table dialog box.

■ Setup Node ()

The Setup node has four sub-nodes. You can do the following with the Setup node:

- 1) Double-click it to expand or collapse the list of its sub-nodes.

■ General Setup Node ()

You can do the following with the General Setup node:

- 1) Double-click it to open the General Setup dialog box.
- 2) Right-click it to get a pop-up menu with the following menu item:

Menu Item	Description
Properties...	Open the General Setup dialog box.

■ Command & Status Node ()

You can do the following with the Command & Status node:

- 1) Double-click it to open the Command & Status dialog box.
- 2) Right-click it to get a pop-up menu with the following menu item:

Menu Item	Description
Properties...	Open the Command & Status dialog box.

■ Clock Node ()

You can do the following with the Clock node:

- 1) Double-click it to open the Clock dialog box.
- 2) Right-click it to get a pop-up menu with the following menu item:

Menu Item	Description
Properties...	Open the Clock dialog box.

■ Passwords Node ()

You can do the following with the Passwords node:

- 1) Double-click it to open the Passwords dialog box.
- 2) Right-click it to get a pop-up menu with the following menu item:

Menu Item	Description
Properties...	Open the Passwords dialog box.

■ Screens Node ()

The Screens node can have many Screen sub-nodes. Each Screen sub-nodes is associated with a screen of the panel application. You can do the following with the Screens node:

- 1) Double-click it to expand or collapse the list of its sub-nodes.
- 2) Right-click it to get a pop-up menu with the following menu item:

Menu Item	Description
New Screen...	Create a new screen.
Import Screen...	Import a screen from an SNF file.
Sort by Name	Sort the list of Screen sub-nodes by the screen name.
Sort by Number	Sort the list of Screen sub-nodes by the screen number.
Close All Screens	Close all opened screens.
Save Screens as Pictures...	Open the Save Screens as Pictures dialog box. You can save each of the selected screens to a picture file using the dialog box.

■ Screen sub-Node ()

Each Screen sub-Node is associated with a screen of the panel application. You can do the following with the Screen sub-node:

- 1) Double-click it to open the associated screen if the screen is not opened yet.
- 2) Double-click it to open the property sheet of the associated screen if the screen is already opened.
- 3) Right-click it to get a pop-up menu with the following menu item:

Menu Item	Description
Open	Open the associated screen.
Delete	Delete the associated screen.
Properties	Open the property sheet of the associated screen.
Export Screen...	Export the associated screen to an SNF file.

■ Alarms Node ()

The Alarms node can have many Discrete Alarm Block sub-nodes and Analog Alarm Block sub-nodes. You can do the following with the Alarms node:

- 1) Double-click it to open the Alarm Properties dialog box.
- 2) Right-click it to get a pop-up menu with the following menu item:

Menu Item	Description
Add Discrete Alarm Block	Create a new discrete alarm block.
Add Analog Alarm Block	Create a new analog alarm block.
Import Alarm Block...	Import an alarm block from an ALM file.
Properties	Open the Alarm Properties dialog box.

■ Discrete Alarm Block Node ()

A Discrete Alarm Block node is associated with a discrete alarm block of the panel application. You can do the following with the Discrete Alarm Block node:

- 1) Double-click it to open the Discrete Alarm Block dialog box of the associated alarm block.
- 2) Right-click it to get a pop-up menu with the following menu item:

Menu Item	Description
Delete	Delete the associated discrete alarm block.
Properties	Open the Discrete Alarm Block dialog box of the associated discrete alarm block.
Export Alarm Block...	Export the associated alarm block to an ALM file.

■ Analog Alarm Block Node ()

An Analog Alarm Block node is associated with an analog alarm block of the panel application. You can do the following with the Analog Alarm Block node:

- 1) Double-click it to open the Analog Alarm Block dialog box of the associated alarm block.
- 2) Right-click it to get a pop-up menu with the following menu item:

Menu Item	Description
Delete	Delete the associated analog alarm block.
Properties	Open the Analog Alarm Block dialog box of the associated analog alarm block.
Export Alarm Block...	Export the associated alarm block to an ALM file.

■ Recipes Node ()

The Recipes node can have many Recipe Block sub-nodes. Each Recipe Block sub-node is associated with a recipe block of the panel application. You can do the following with the Recipes node:

- 1) Double-click it to expand or collapse the list of its sub-nodes.
- 2) Right-click it to get a pop-up menu with the following menu item:

Menu Item	Description
Add Recipe Block	Create a new recipe block.

■ Recipe Block Node ()

A Recipe Block node is associated with a recipe block of the panel application. You can do the following with the Recipe Block node:

- 1) Double-click it to open the Recipe Block dialog box of the associated recipe block.
- 2) Right-click it to get a pop-up menu with the following menu item:

Menu Item	Description
Delete	Delete the associated recipe block.
Properties	Open the Recipe Block dialog box of the associated recipe block.

■ Data Loggers Node ()

The Data Loggers node can have many Data Logger sub-nodes. Each Data Logger sub-node is associated with a data logger of the panel application. You can do the following with the Data Loggers node:

- 1) Double-click it to expand or collapse the list of its sub-nodes.
- 2) Right-click it to get a pop-up menu with the following menu item:

Menu Item	Description
Add Data Logger	Create a new data logger.

■ Data Logger Node ()

A Data Logger node is associated with a data logger of the panel application. You can do the following with the Data Logger node:

- 1) Double-click it to open the Data Logger dialog box of the associated recipe block.
- 2) Right-click it to get a pop-up menu with the following menu item:

Menu Item	Description
Delete	Delete the associated data logger.
Properties	Open the Data Logger dialog box of the associated data logger.

■ Operation Logging Node ()

You can do the following with the Operation Logging node:

- 1) Double-click it to open the Operation Logging dialog box.
- 2) Right-click it to get a pop-up menu with the following menu item:

Menu Item	Description
Properties...	Open the Operation Logging dialog box.

■ Schedule Node ()

You can do the following with the Schedule node:

- 1) Double-click it to open the Schedule dialog box.
- 2) Right-click it to get a pop-up menu with the following menu item:

Menu Item	Description
Properties...	Open the Schedule dialog box.

■ Macros Node ()

The Macros node can have many Macro sub-nodes. Each Macros sub-node is associated with a macro of the panel application. You can do the following with the Macros node:

- 1) Double-click it to expand or collapse the list of its sub-nodes.
- 2) Right-click it to get a pop-up menu with the following menu items.

Menu Item	Description
Add Macro...	Create a new macro.
Import Macro...	Import a macro from an MCR file.

■ Macro Node ()

Each Macro node is associated with a macro of the panel application. You can do the following with the Macro node:

- 1) Double-click it to open the editing window of the associated macro.
- 2) Right-click it to get a pop-up menu with the following menu items.

Menu Item	Description
Open	Open the editing window of the associated macro.
Close	Close the editing window of the associated macro.
Rename	Rename the associated macro.
Delete	Delete the associated macro.
Export Macro...	Export the associated macro to an MCR file.

1.2.4. Screen Manager

The Screen Manager is a dockable window. You can manage the screens of your project with it easily. To open the Screen Manager, check the Screen Manager menu item in the View menu. The following is an example of the Screen Manager that lists the screens of the application EV-104 of the project.

The name of the current panel application. You can select another panel application of the project to view.

If the Use box of a screen is checked, the application compiler will generate the runtime data for that screen. If the Use box of a screen is unchecked, the application compiler will not generate the runtime data for that screen, and will assume that the screen is non-existent.

Click this icon to get the list view of the screens.

Click this icon to get the thumbnail view of the screens.

Click the row of a screen to select the screen. The selected screen is highlighted. Use [Ctrl] + click or [Shift] + click to make multiple selections.

Use	Number	Name
<input checked="" type="checkbox"/>	1	Base
<input checked="" type="checkbox"/>	2	Extrusor
<input checked="" type="checkbox"/>	3	Operador
<input checked="" type="checkbox"/>	4	Tiempos Comunes
<input checked="" type="checkbox"/>	5	Tiempos x Estac
<input checked="" type="checkbox"/>	6	Producción
<input checked="" type="checkbox"/>	7	Memoria
<input checked="" type="checkbox"/>	8	Ingenieria 1
<input checked="" type="checkbox"/>	9	Mimico
<input checked="" type="checkbox"/>	10	Neumática
<input checked="" type="checkbox"/>	11	Hidráulica
<input checked="" type="checkbox"/>	12	Variadores
<input checked="" type="checkbox"/>	13	Crono
<input checked="" type="checkbox"/>	14	Programador
<input checked="" type="checkbox"/>	15	Alfa
<input checked="" type="checkbox"/>	16	Alarmas
<input checked="" type="checkbox"/>	17	SEW
<input checked="" type="checkbox"/>	18	Entradas
<input checked="" type="checkbox"/>	19	Alarmas_Listado
<input checked="" type="checkbox"/>	20	Menu
<input checked="" type="checkbox"/>	21	Numerico
<input checked="" type="checkbox"/>	30	Screensaver

Size:640X480;

The following is an example of the Screen Manager that shows the screens in thumbnail view.

If the Use box of a screen is checked, the application compiler will generate the runtime data for that screen. If the Use box of a screen is unchecked, the application compiler will not generate the runtime data for that screen, and will assume that the screen is non-existent.

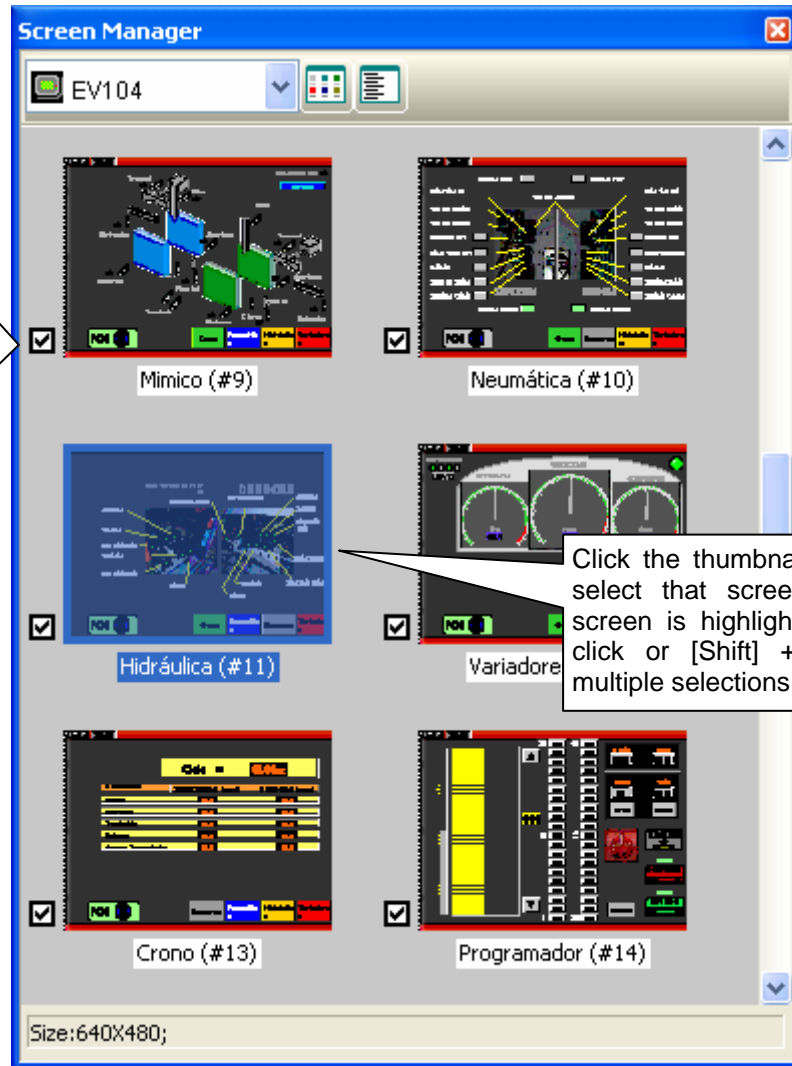











You can right-click the Screen Manager to get the pop-up menu with the following menu items:

Menu Item	Description
New Screen...	Create a new screen for the current panel application.
Open Screen...	Open the selected screen.
Cut Screen	Cut the selected screen and put it on the Clipboard.
Copy Screen	Copy the selected screen and put it on the Clipboard.
Paste Screen	Insert the screen on the Clipboard to the current panel application.
Delete Screen	Delete the selected screen.
Export Screen...	Export the selected screen to a file.
Import Screen...	Import a screen from a file for the current panel application.
Screen Properties	Open the screen property dialog box of the selected screen.

1.2.5. Pop-up Menus

1.2.5.1. Object Pop-up Menu

■ For all objects

Icon	Menu Item	Shortcut	Description
	Cut	Ctrl+X	Cut the selection and put it on the Clipboard.
	Copy	Ctrl+C	Copy the selection and put it on the Clipboard.
	Paste	Ctrl+V	Place the Clipboard contents on the current screen.
	Delete	Del	Delete the selection.
	Pin		Pin the selection so it cannot move.
	Unpin		Unpin the selection so it can move again.
	Duplicate...		Duplicate the selected object.
	Bring to Top		Bring the selection to the top.
	Bring Forward		Bring the selected object one layer up.
	Send Backward		Send the selected object one layer down.
	Send to Bottom		Send the selection to the bottom.
	Object Properties...		Open the property sheet of the selected object.
	Save as Default		Save the selected object as the default object for that type of object. Default objects are saved in the Objects category of the object library.
	Save to Object Library...		Save the selected object to the object library.
	Save as Global Object...		Save the selected object as the global object in the Global category of the object library. Global Objects can be used for the Global Object Containers.
	Save Current Screen as Picture...		Save the current screen to a picture file.
	Screen Properties		Open the screen property dialog box for the current screen.

■ For polylines and polygons

Menu Item	Description
Insert Point	Add a point at the specified position.
Delete Point	Delete a selected point.

■ For pipelines

Menu Item	Description
Insert Connector	Add a connector at the specified position. If the specified position is on the vertical pipe segment, you can add left, right or cross connector. If the specified position is on the horizontal pipe segment, you can add up, down or cross connector.
Delete Pipe Segment	Delete a selected connector and its pipe segments.

1.2.5.2. Screen Pop-up Menu

Icon	Menu Item	Description
	Close Screen	Close the current screen.
	Cut Screen	Cut the current screen and put it on the Clipboard.
	Copy Screen	Copy the current screen and put it on the Clipboard.
	Paste Screen	Insert the screen on the Clipboard to the current panel application.
	Delete Screen	Delete the current screen.
	Save Current Screen as Picture...	Save the current screen to a picture file.
	Screen Properties	Open the screen property dialog box for the current screen.

CHAPTER 2

CREATING PROJECTS

2.1.	Project Information and Protection	1
2.2.	Global Settings	3
2.2.1.	Languages	4
2.2.2.	Font Templates.....	5
2.2.3.	Picture Database	6
2.2.4.	Sound Database	10
2.2.5.	Text Database.....	12
2.3.	Working with Tags.....	15
2.3.1.	Types of Tags	15
2.3.2.	Opening and Closing Tags Editor.....	15
2.3.3.	Creating Tags with Tags Editor.....	16
2.3.4.	Importing and Exporting Tags.....	19
2.3.5.	Adding/Deleting/Renaming Tag Groups.....	19

2.1. Project Information and Protection



You can get project information and set up passwords to protect your project, password table, and global macros by using the Project information & Protection dialog box. To open the dialog box, you can do one of the following:

- 1) In the Project Manager tool window, double-click the Project node (📁).
- 2) In the menu bar, click Project to bring up the Project sub-menu. Then, click Information & Protection....

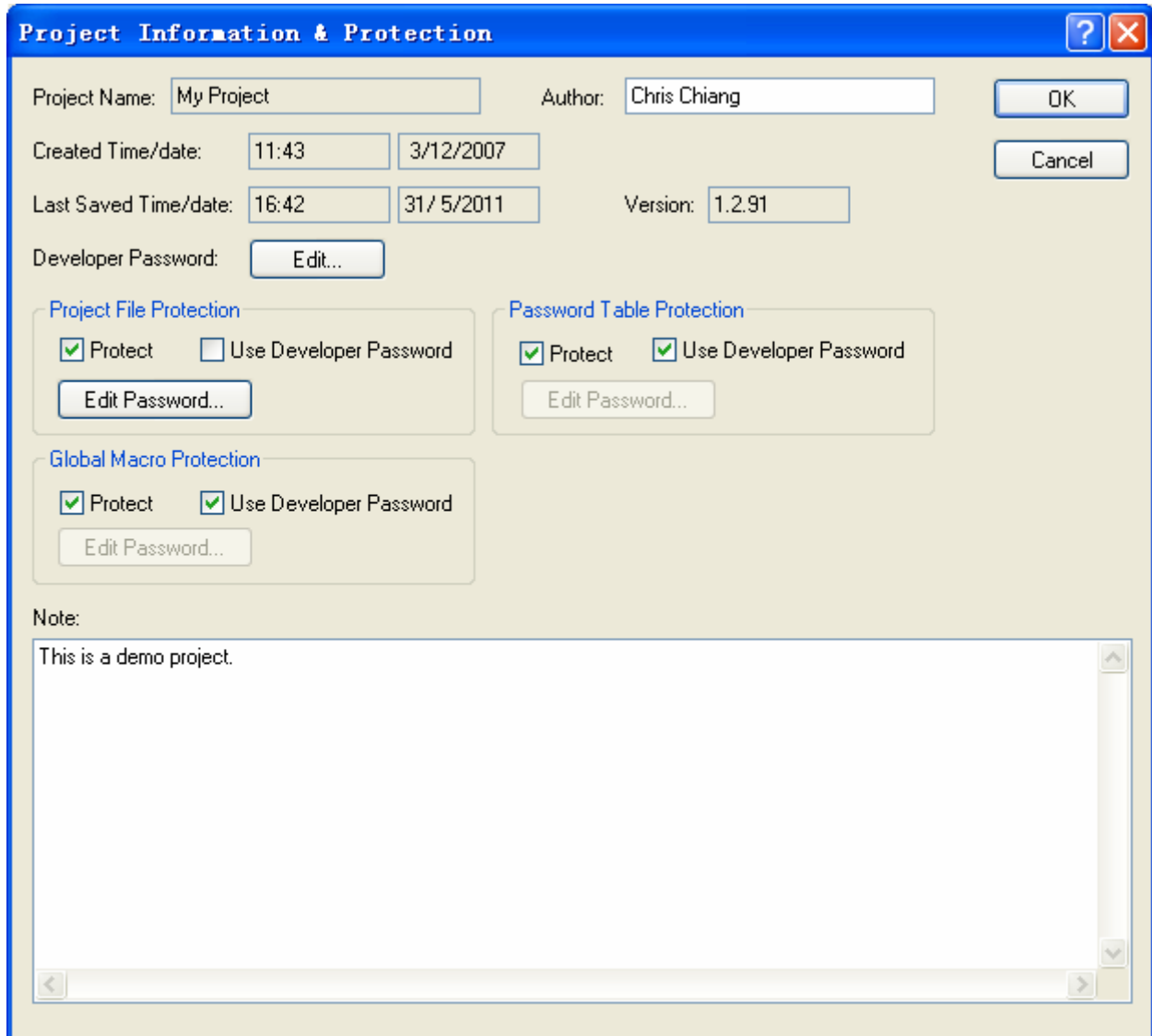
The following is an example of the Project Information and Protection dialog box.

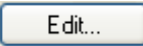
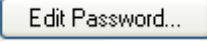
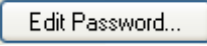
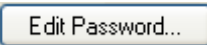

The following table describes how to read or use each of the items in the dialog box.

Item		Description
Project Name		The name of the project. It is also the file name of the project.
Author		The author of the project.
Created Time/date		The time and date when the project was created.
Last Saved Time/date		The last time and date when the project was saved.
Version		The version number of the Software that was used to save the project last time.
Developer Password		Click it to bring up the Edit Developer Password dialog box and specify the developer password. The developer password must be an unsigned integer and can have up to 9 digits. The default developer password is 000000000 (nine 0s) for new projects and new panels. When the runtime data of an application is downloaded to a panel, the panel compares its developer password with the developer password of the application. If the passwords match, the panel accepts the download operation immediately. If the passwords are different, the panel prompts for the entry of the developer password of the application. This ensures that one has the right to use the runtime data. After the entry of the application's developer password, the panel accepts the download operation and takes the developer password of the application as its own developer password.
Project File Protection	Protect	Check this item to enable project file protection. You need to enter the specified password to open the project file when this item is checked.
	Use Developer Password	Available when the Protect item is checked. Check this item if you want to use the developer password as the protection.
		Available when the Use Developer Password item is unchecked. Click it to bring up the Edit Password dialog box and specify the password.
Password Table Protection	Protect	Check this item to enable the password table protection. You need to enter the specified password in order to view the password table of any panel application of the project when this item is checked.
	Use Developer Password	Available when the Protect item is checked. Check this item if you want to use the developer password for the protection.
		Available when the Use Developer Password item is unchecked. Click it to bring up the Edit Password dialog box and specify the password.
Global Macro Protection	Protect	Check this item to enable the global macro protection. You need to enter the specified password for viewing any global macro of the project when this item is checked.
	Use Developer Password	Available when the Protect item is checked. Check this item if you want to use the developer password as the protection.
		Available when the Use Developer Password item is unchecked. Click it to bring up the Edit Password dialog box and specify the password.
Note		You can type a note for the project.
OK		Click it to close the dialog box and accept all changes.
Cancel		Click it to close the dialog box and discard all changes.
		Click it to open the help document for more details about the dialog and how to use it.
		Click it to close the dialog box and discard all changes.

2.2. Global Settings

Global settings are the settings that can be used by all panel applications in the same project. They are accessible and modifiable throughout the project. Global settings help a designer to construct a project that is flexible and easy to update. Designers can make changes to the overall design of the panel application by revising the global settings directly.

You can modify the Global settings in the corresponding dialog box. To open the dialog box, double-click the related node under the Global node in the Project Manager tool window. Alternatively, click Project to access the Project sub-menu in the menu bar, and then click the related command in the Project sub-menu.

The global settings contain the following items.



- **Languages**
Described in [Section 2.2.1.](#)
- **Font Templates**
Described in [Section 2.2.2.](#)
- **Picture Database**
Described in [Section 2.2.3.](#)
- **Sound Database**
Described in [Section 2.2.4.](#)
- **Text Database**
Described in [Section 2.2.5.](#)
- **Global Tags**
Described in [Section 2.3.](#)
- **Global Macros**
Described in [Chapter 14.](#)

2.2.1. Languages

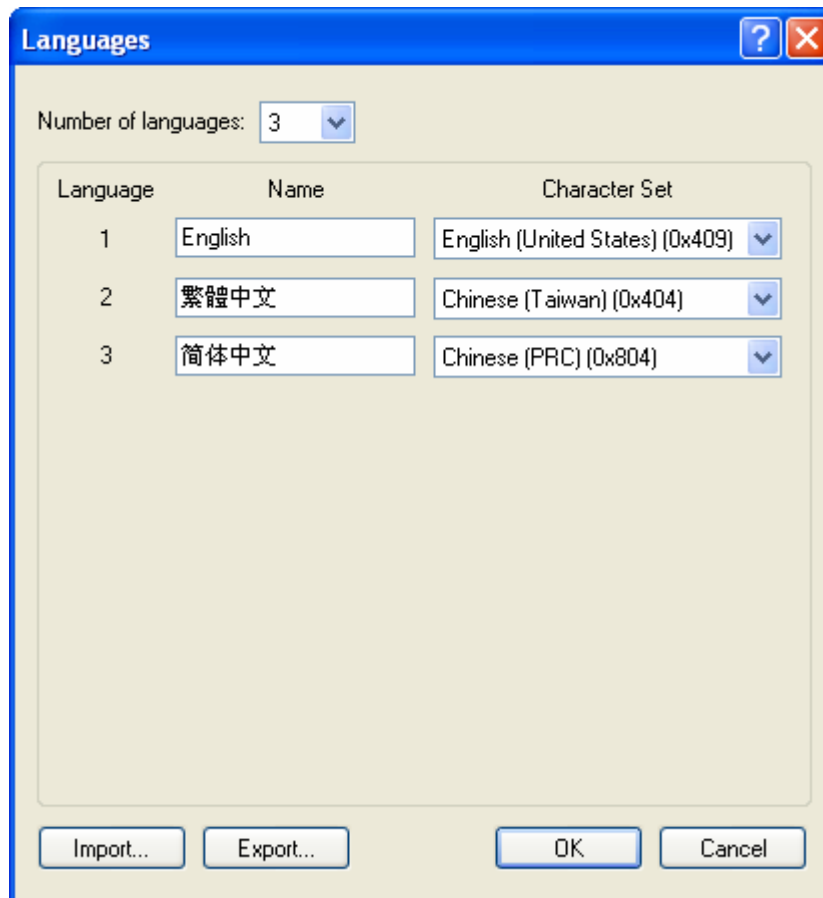
This section describes how to set up the languages for the project using the Languages dialog box. Each panel application in the project can have up to 10 languages for the screen texts. The following is an example of the Languages dialog box.



The following table describes each property in the Languages dialog box.



Property	Description
Number of languages	Specifies how many languages the project will have.
Language	The index of the language.
Name	Specifies a name for a language. The name must be unique within the project.
Character Set	Specifies the character set for a language to determine how to translate the bytes in the text into characters on the screen.
Import...	Click it to import the languages settings from a LNG file.
Export...	Click it to export the languages settings to a LNG file.
OK	Click it to close the dialog box and accepts all changes.
Cancel	Click it to close the dialog box and discard all changes.
	Click it to open the help document for more details about the dialog and how to use it.
	Click it to close the dialog box and discard all changes.

2.2.2. Font Templates

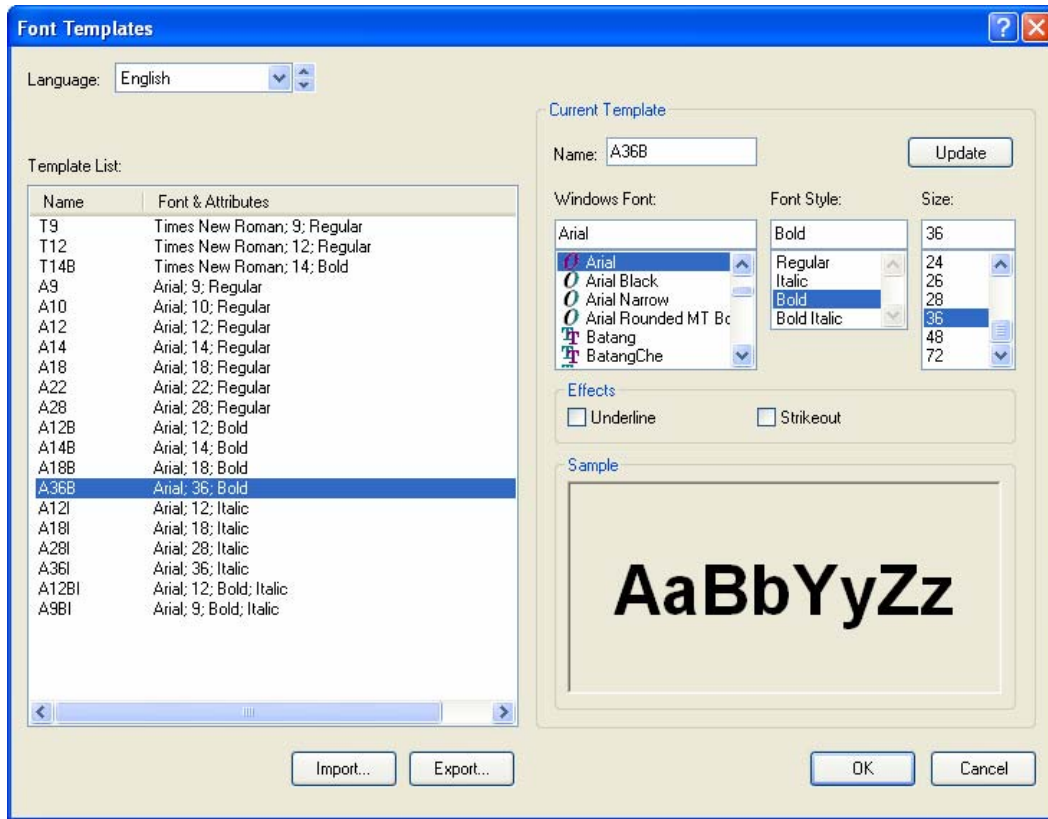
The following is an example of the Font Templates dialog box.



The following table describes how to read or use each of the items in the dialog box.

Item	Description	
Language	Specifies the language to apply the font settings to.	
Template List	Lists the font templates of the selected language. You can select a font template here as the current template.	
Current Template	Name	The name of the current template.
	Windows Font	Specifies the Windows font for the current template.
	Font Style	Specifies the font style for the current template.
	Size	Specifies the size for the current template.
	Underline	Specifies if the Underline feature is selected for the current template.
	Strikeout	Specifies if the Strikeout feature is selected for the current template.
	Update	Click it to update the selected template using the new settings.
Import...	Click it to import the font templates from an FTF file.	
Export...	Click it to export the font templates to an FTF file.	
OK	Click it to close the dialog box and accepts all changes.	
Cancel	Click it to close the dialog box and discard all changes.	
	Click it to open the help document for more details about the dialog and how to use it.	
	Click it to close the dialog box and discard all changes.	



2.2.3. Picture Database

The picture database contains all the pictures used by the project. The picture database is empty when the project is initially created.

2.2.3.1. Importing and Exporting Pictures

■ Importing Pictures

You need to import a picture before you can use it for the project. There are 5 ways to import pictures:

- 1) Use the Picture Database dialog box to import one picture at a time from a picture file. The types of importable picture files include: BMP, JPG, GIF, and WMF.
- 2) Use the Picture Database dialog box to import many pictures at a time from a picture database (PDB) file.
- 3) Use the Picture Database dialog box to import one or many pictures at a time by dragging the pictures files from Windows Explorer to the Picture Database list.
- 4) Click the icon  to select and import a picture file when you specify a picture in a dialog box or a property sheet.
- 5) Click the icon  to select and import a picture in a picture database file when you specify a picture in a dialog box or a property sheet.

■ Exporting Pictures

You can export the pictures of the project so other projects can use those pictures by importing them. There are 2 ways to export pictures:

- 1) Use the Picture Database dialog box to export one picture at a time to a picture file.
- 2) Use the Picture Database dialog box to export many pictures at a time to a picture database (PDB) file.

2.2.3.2. Picture Groups







The picture database can contain picture groups.

A picture group is a collection of pictures. Each picture in a picture group represents one state. When a picture group is displayed as the picture shape of an object, the picture that corresponds to the current object state is shown. This is the main benefit of using a picture group as the object shape because it can show each object state with a different picture.

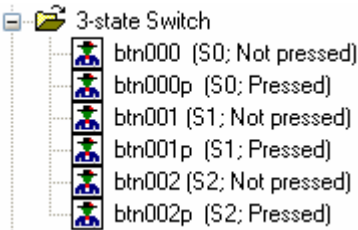
When a picture group is used as the shape for buttons or switches, you may want it to look differently when it is pressed. In order to support the pressed look, a picture group needs two pictures for each state: one picture for the normal (released) look, and another picture is for the pressed look.

For example, a 3-state multi-state switch needs a picture group that contains 6 pictures as its picture shape if the pressed look is required.

The following is an example of a picture group supporting 3 states and the pressed look.

Picture Group	State	Pictures
	0 (Normal/Released)	
	0 (Pressed)	
	1 (Normal/Released)	
	1 (Pressed)	
	2 (Normal/Released)	
	2 (Pressed)	

2.2.3.3. Picture Database dialog box



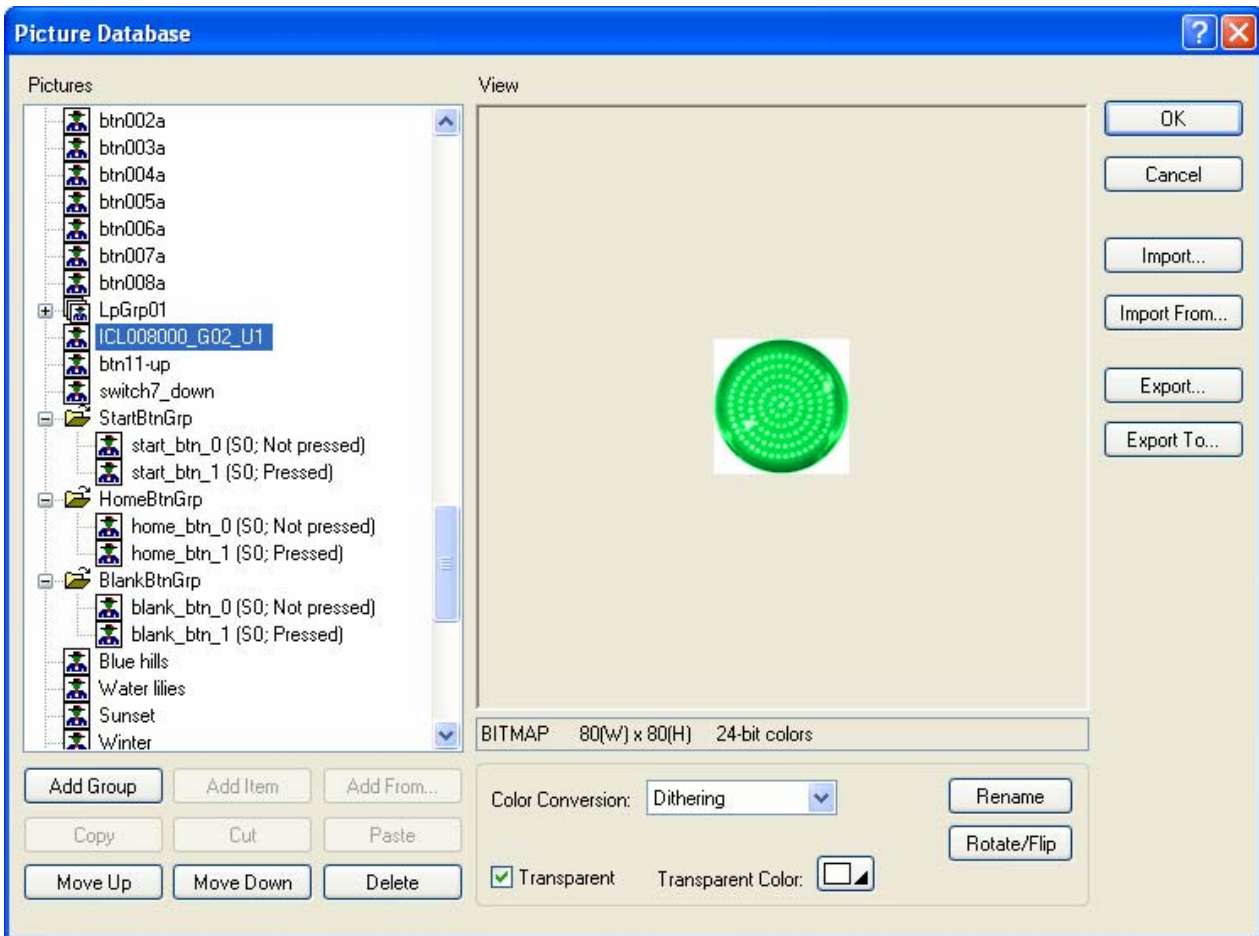























The following is an example of the Picture Database dialog box.



The following table describes how to read or use each of the items in the dialog box.

Item	Description
	Click it to open the help document for more details about the dialog and how to use it.
	Click it to close the dialog box and discard all changes.
Pictures	Lists the pictures and picture groups of the project. You can select a picture or a picture group as the current selection. You can also make multiple selections.
View	Shows the current selection. If the selection is a picture group, the first picture of the group will be shown.
OK	Closes the dialog box and accepts all changes to the picture database.
Cancel	Closes the dialog box and discards all changes to the picture database.
Import...	Imports a picture from a picture file. The types of importable picture files include: BMP, JPG, GIF, and WMF.
Import From...	Imports pictures from a picture database (PDB) file.
Export...	Exports the current picture to a picture file.
Export To...	Exports the current selection to a picture database (PDB) file.
Add Group	Adds one picture group to the picture database.
Add Item	Imports a picture from a picture file and adds the picture to the current picture group.

Continued

Item	Description																
Add From...	Imports pictures from a picture database (PDB) file and adds those pictures to the current picture group.																
Move Up	Moves the selection down in the list																
Move Down	Moves the selection up in the list																
Delete	Delete the selection.																
Color Conversion	Select Dithering or Nearest Color as the color conversion method. If the color resolution of a picture is not compatible with the target panel, the application compiler will use the specified method to convert the picture data so it can be displayed without too much color distortion at runtime.																
Support Pressed Look	Available when the selection is a picture group. Check this item so the current picture group supports the pressed look. When a picture group supports the pressed look, it needs two pictures for each state; one picture is for the normal (released) look and another picture is for the pressed look.																
Transparent	<p>Check this item to enable the transparent feature of the selection; if the selection is a picture, the picture will be transparent for the specified transparent color; if the selection is a picture group, all the pictures of the picture group will be transparent for the specified transparent color. Note that this feature is effective only when a picture or a picture group is shown as the picture shape for an object.</p> <p>It is a common practice to make a picture transparent for a certain color so the picture can be shown as a non-rectangle shape. The following are some examples:</p> <table border="1"> <thead> <tr> <th>Original Picture</th> <th>Transparent Color</th> <th>Picture Shown</th> </tr> </thead> <tbody> <tr> <td></td> <td></td> <td></td> </tr> <tr> <td></td> <td></td> <td></td> </tr> <tr> <td></td> <td></td> <td></td> </tr> </tbody> </table>	Original Picture	Transparent Color	Picture Shown													
Original Picture	Transparent Color	Picture Shown															
																	
																	
																	
Transparent Color	Available when the Transparent item is checked. Select a color for the transparent color.																
Rename	Click this button to rename the current picture or the current picture group.																
Rotate/Flip	<p>Rotates or flips the current picture and saves it as another picture in the picture database. You can select one of the following 7 methods for the Rotate/Flip operation.</p> <table border="1"> <thead> <tr> <th>Method</th> <th>Description</th> </tr> </thead> <tbody> <tr> <td>90°</td> <td>Rotates the picture clockwise by 90 degrees</td> </tr> <tr> <td>180°</td> <td>Rotates the picture clockwise by 180 degrees</td> </tr> <tr> <td>270°</td> <td>Rotates the picture clockwise by 270 degrees</td> </tr> <tr> <td>X</td> <td>Flips the picture over the X axis</td> </tr> <tr> <td>90° & X</td> <td>Rotates the picture clockwise by 90 degrees and flips it over the X Axis</td> </tr> <tr> <td>Y</td> <td>Flips the picture over the Y axis</td> </tr> <tr> <td>90° & Y</td> <td>Rotates the picture clockwise by 90 degrees and flips it over the Y Axis</td> </tr> </tbody> </table>	Method	Description	90°	Rotates the picture clockwise by 90 degrees	180°	Rotates the picture clockwise by 180 degrees	270°	Rotates the picture clockwise by 270 degrees	X	Flips the picture over the X axis	90° & X	Rotates the picture clockwise by 90 degrees and flips it over the X Axis	Y	Flips the picture over the Y axis	90° & Y	Rotates the picture clockwise by 90 degrees and flips it over the Y Axis
Method	Description																
90°	Rotates the picture clockwise by 90 degrees																
180°	Rotates the picture clockwise by 180 degrees																
270°	Rotates the picture clockwise by 270 degrees																
X	Flips the picture over the X axis																
90° & X	Rotates the picture clockwise by 90 degrees and flips it over the X Axis																
Y	Flips the picture over the Y axis																
90° & Y	Rotates the picture clockwise by 90 degrees and flips it over the Y Axis																

2.2.4. Sound Database

The sound database contains all the sounds used by the project. The sound database is empty when the project is initially created.

You can use a function button to play or stop playing a sound. For details, please see [Section 5.4.1 Basic Operations](#) of function buttons

You can use the Execute General Command (\$C2.f) command flag setting in the Command Block to play a sound. For details, please see [Section 3.6.7 Using General Commands](#).

2.2.4.1. Importing and Exporting Sounds

■ Importing Sounds

You need to import a sound before you can use it for the project. There are two ways to import sounds:

- 1) Use the Sound Database dialog box to import one sound at a time from a sound file. The types of importable sound files include: WAV.
- 2) Use the Sound Database dialog box to import many sounds at a time from a sound database (SDB) file.

■ Exporting Sounds

You can export the sounds of the project so other projects can import those sounds. There are 2 ways to export sounds:

- 1) Use the Sound Database dialog box to export one sound at a time to a sound file.
- 2) Use the Sound Database dialog box to export many sounds at a time to a sound database (SDB) file.

2.2.4.2. Sound Database dialog box

The following is an example of the Sound Database dialog box.

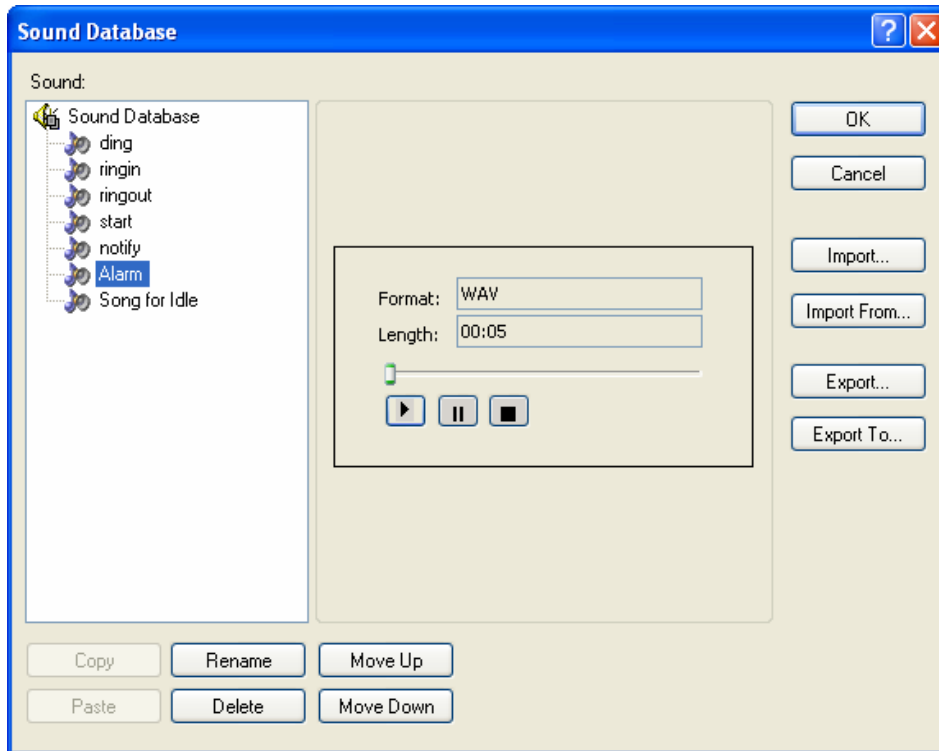

The following table describes how to read or use each of the items in the dialog box.

Item	Description
	Click it to open the help document for more details about the dialog and how to use it.
	Click it to close the dialog box and discard all changes.
Sounds	Lists the sounds of the project. You can select a sound as the current selection. You can also make multiple selections.
Sound Information	Displays the sound information of the current selection such as sound format and length. You can click to start playing the sound, click to pause, and click to stop playing the sound.
OK	Closes the dialog box and accepts all changes to the sound database.
Cancel	Closes the dialog box and discards all changes to the sound database.
Import...	Imports a sound from a sound file. The types of importable sound files include: WAV.
Import From...	Imports sounds from a sound database (SDB) file.
Export...	Exports the current sound to a sound file.
Export To...	Exports the current selection to a sound database (SDB) file.
Rename	Click this button to rename the current sound.
Delete	Delete the selection.
Move Up	Moves the selection down in the list
Move Down	Moves the selection up in the list

2.2.5. Text Database

The Text Database is a dockable window. With the Text Database, you can manage the texts of the multiple languages in your project easily. To open the Text Database, check the Text Database menu item in the Project menu, or double click the Text Database node under the Global node in the Project Manager tool window.

The following is an example of the Text Database that lists the texts in all the languages of the project.

The screenshot shows the 'Text Database' window with a table containing the following data:

String ID	English	繁體中文	简体中文
A0001	General	一般設定	一般设定
A0002	Touch Panel	校正觸摸面板	校正触摸面板
A0003	Link 1	連線一	连接一
A0004	Link 2	連線二	连接二
A0005	Panel Setup	人機設置	人机设置
A0006	Run	運行	运行
A0007	Copy AP to HMI	複製應用到人機	复制应用到人机
A0008	Link 3	連線三	连接三
A0009	Link 4	連線四	连接四
A0010	Boot from File	從檔案運行應用	从文件运行应用
A0011	Update from File	從檔案更新應用	从文件更新应用
A0012	Copy AP to File	複製應用到檔案	复制应用到文件
A0013	FTP Site	FTP伺服器	FTP 服务器
A0014	Clear Recorded Data	清除記錄數據	清除记录数据
A0015	LAN Printer Address	網路印表機地址	网络打印机地址
A0016	Set Time/Date	設定萬年曆	设定万年历
A0017	Check Battery:	檢查電池:	检查电池:
A0018	False	否	否
A0019	True	是	是
A0020	Screen Saver Time (minutes):	螢幕保護時間(分):	屏幕保护时间(分):
A0021	Allow To Run Panel Setup:	允許執行人機設置程式:	允许执行人机设置程序:
A0022		開機後執行應用程序:	开机后执行应用程序:
A0023		網路印表機地址	网络打印机地址
A0024		增	增
A0025		減	减
A0026		減	减



Callouts in the image explain the following elements:



- File to Table Icon:** A folder icon used to create a new table.
- Table to File Icon:** A document icon used to save the current table to a file.
- Table to Application Icon:** An application icon used to load the current table into the application.
- Application to Table Icon:** A document icon used to save the current table from the application.
- Name of the table:** A dropdown menu showing 'Table A', indicating that users can select different tables.

To edit text, select a text row by first left-click anywhere in it, and then click the cell of the row to bring up the edit box. In the edit box, type in the text.

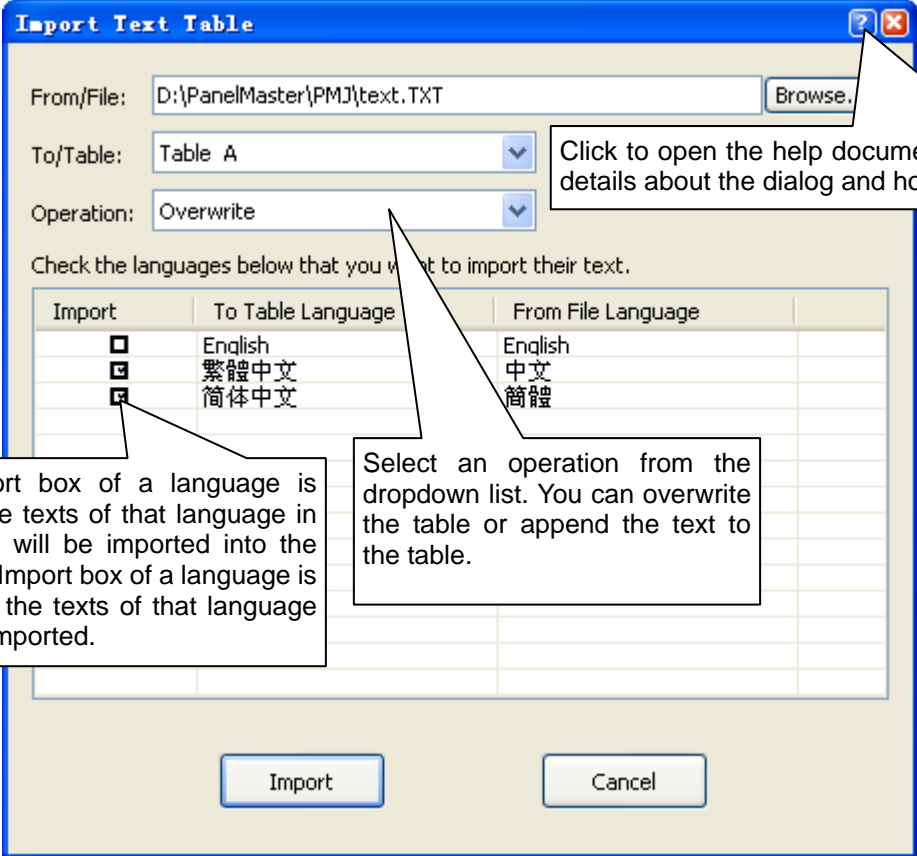
To stop or confirm editing, click anywhere outside the selected row.

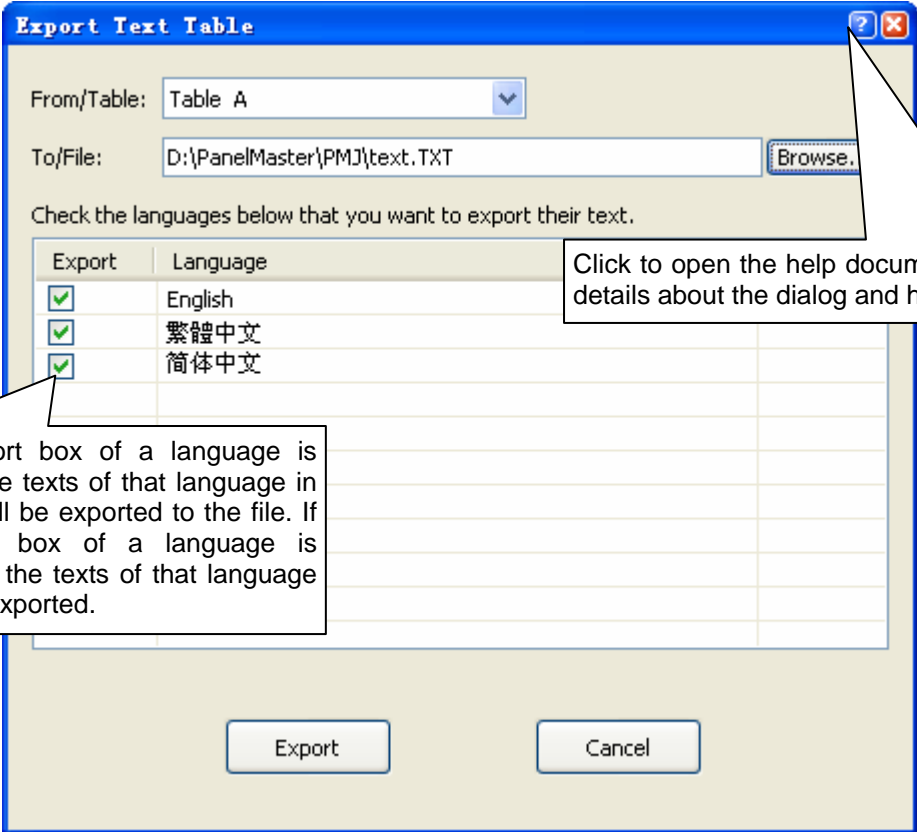
You can click the following icons to bring up the corresponding dialog box to import or export texts.

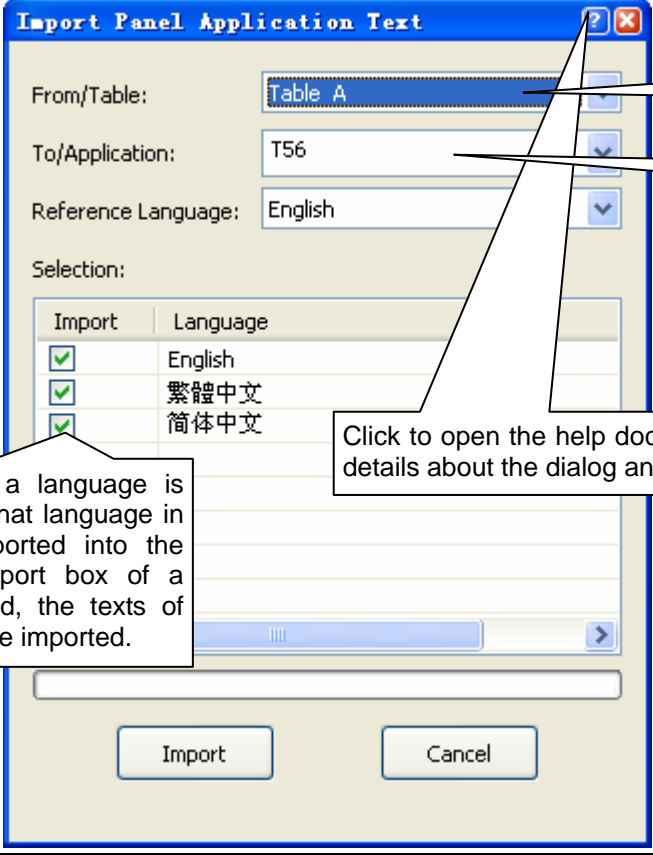
Icon	Description
	<p data-bbox="212 286 890 320">Imports texts from a text file(.txt file) to the selected table.</p>  <p data-bbox="212 786 694 981">If the Import box of a language is checked, the texts of that language in the text file will be imported into the table. If the Import box of a language is unchecked, the texts of that language will not be imported.</p> <p data-bbox="722 763 1129 925">Select an operation from the dropdown list. You can overwrite the table or append the text to the table.</p> <p data-bbox="922 454 1441 521">Click to open the help document for more details about the dialog and how to use it.</p>
	<p data-bbox="212 1189 898 1223">Exports texts from the selected table to a text file (.txt file).</p>  <p data-bbox="212 1659 694 1854">If the Export box of a language is checked, the texts of that language in the table will be exported to the file. If the Export box of a language is unchecked, the texts of that language will not be exported.</p> <p data-bbox="938 1469 1457 1536">Click to open the help document for more details about the dialog and how to use it.</p>

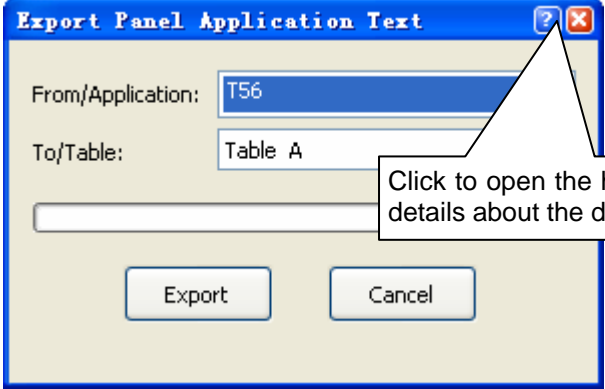
Icon	Description
	<p>Imports texts from the selected table to a panel application in the same project.</p>  <p>If the Import box of a language is checked, the texts of that language in the table will be imported into the application. If the Import box of a language is unchecked, the texts of that language will not be imported.</p> <p>Click to open the help document for more details about the dialog and how to use it.</p>
	<p>Exports texts from a panel application of the project to the selected table.</p>  <p>Click to open the help document for more details about the dialog and how to use it.</p>

You can right-click the Text Database to get the pop-up menu with the following menu items:

Menu Item	Description
Cut	Cut the selected text and put it on the Clipboard.
Copy	Copy the selected text and put it on the Clipboard.
Paste	Insert the text on the Clipboard to the current table.
Delete	Delete the selected text.
<Language name>	Check the language name to display the text of objects in the selected language.

2.3. Working with Tags

A tag represents a single input or output variable monitored or controlled by the system. By changing tags, you can use any PLC or controller without re-developing the application. This chapter explains how you can define and manage tags with the tags editor.

After the tag is created in tags editor, you can use it in your application using the Select Tag Dialog Box. Please see [Section 4.4.3.3 Selecting Tags](#) for details. Or you can specify the tag by yourself. The format of a tag is Link Number\Tag Group Name\Tag Name.

For example:

Tags	Description
1\MONITOR\CORE DISPLAY	Indicates a local tag named CORE DISPLAY in MONITOR tag group of link 1
0\BOT\DECLARE	Indicates a local tag named DECLARE in BOT tag group of internal memory
0_ALARM SHOW	Indicates a global tag named _ALARM SHOW of internal memory

Note that the maximum text amount of the tag/tag group name is 48 characters. You are allowed to define not only tags for the link, but also the tags for a tag group of the link.

2.3.1. Types of Tags

There are two types of tags: global tags and local tags.

■ Global Tag

A global tag is a tag that can be used by all panel applications in the same project. With global tags, the panel applications in the same project can share the common address declaration without having to keep and maintain the same set of tags locally.

Note that a global tag can only be associated with internal variables.

■ Local Tag

A local tag is a tag that can only be used by the panel application in which the tag is located.

2.3.2. Opening and Closing Tags Editor

■ Opening Tags Editor

To open the global tags editor, use the Global Tags... command in the Project menu, or double click Global > Global Tags in the Project Manager tool window, or right-click Global > Global Tags in the Project Manager tool window to bring out the pop-up menu, and then use the Open command on the pop-up menu.

To open the local tags editor, use the Tags... command on the Panel menu, or double click Panel Application > Tags in the Project Manager tool window, or right-click the Panel Application > Tags in the Project Manager tool window to bring out the pop-up menu, and then use the Open command on the pop-up menu.

■ Closing Tags Editor

To close the tags editor, select the window and click the close button, or choose Windows... on the Window menu, select the window to close in the window dialog, and then click the Close Window(s) button. You can also right-click Global > Global Tags (Panel Application > Tags) in the Project Manager tool window to bring out the pop-up menu, and then use the Close command on the pop-up menu to close the tags editor.

2.3.3. Creating Tags with Tags Editor

You can use tags editor to create and manage tags. Tags editor is split into two panes: Tag Group Explorer on the left and Tag List Window on the right. Each pane scrolls separately, and both horizontally and vertically. You can position the mouse over the vertical splitter bar to drag the bar and resize the panes.

The following is an example of the tags editor.

The screenshot shows the Tags Editor interface. On the left is the Tag Group Explorer, which displays a tree view of tag groups. The 'MONITOR' group is selected. On the right is the Tag List Window, which displays a table of tags for the selected group. The table has the following columns: Name, Data Type, Address, Length, Scan Rate, and Comment. The table contains 17 rows of tag information.

Name	Data Type	Address	Length	Scan Rate	Comment
1 CORE DISPLAY	32-Bit Unsigned Integer	QD512	n/a	Fast	CORE DISP...
2 START TIME	16-Bit Unsigned Integer	QW158	n/a	Fast	START TIME
3 CLM. TIME	16-Bit Unsigned Integer	QW159	n/a	Fast	CLOSE MOL...
4 REC. TIME	16-Bit Unsigned Integer	QW146	n/a	Fast	REC. TIME
5 SBK. TIME	16-Bit Unsigned Integer	QW133	n/a	Fast	SBK. TIME
6 OPM. TIME	16-Bit BCD	QW123	n/a	Fast	OPM. TIME
7 COOL TIME	32-Bit BCD	QD151	n/a	Fast	COOL TIME
8 CLOSE/OPEN BAR	16-Bit Signed Integer	IW23	n/a	Fast	
9 INJ/REC BAR	16-Bit Signed Integer	ID752	n/a	Fast	
10 light	ASCII String	C90	10	Normal	
11 CONTADOR	32-Bit Signed Integer	QD80	n/a	Fast	
12 DEFECTOS	32-Bit Signed Integer	QD200	n/a	Fast	
13 SCREW ROTATE	32-Bit Floating Point	VD56	n/a	Fast	
14 light 1	ASCII String	C200	20	Normal	
15 WSG 1	32-Bit Unsigned Integer	VD82	n/a	Fast	
16 light 2	ASCII String	C400	10	Normal	
17					

2.3.3.1. Tag Group Explorer

Tag explorer displays links, recipes, data loggers and their tag groups, if any. From tags explorer, you can:

- Open a tag group of a link for editing by clicking the node
- Import and export tags of a link
Described in [Section 2.3.4](#)
- Add new groups to a link and delete or rename the existing tag groups
Described in [Section 2.3.5](#)
- View tags (Data Items) of recipes and data loggers.

If there are any recipes or data loggers in the application, the tags editor will display their data items as the tags. All the data items (tags) for the recipes or data loggers are read only in the tags editor. If you want to edit the data items (tags), please use the corresponding dialog box.

You can edit the data items of the selected recipe block with the Recipe Block dialog box. Please see [Section 10.5 Setting up Recipe Blocks](#) for details.

Recipe Block Name (ID)

Data Logger Name (ID)

Recipe Block	
Data Item	
Addr.	Name
CR0:0	Item 0
CR0:1	Item 1
CR0:3	Item 2
CR0:4	Item 3
CR0:6	Item 4
CR0:7	Item 5
CR0:8	Item 6
CR0:9	Item 7

2.3.3.2. Tag List Window

Tag list window displays all the tags related to the selected tag group. In the tag list window, you can:

- Switch between tag groups by clicking the window tab
- Click any column header to sort the list
- Add a tag by defining the tag name and then click other cells to edit the elements of the tag

The following table describes each attribute of the tag.

Item		Description
Name		Specifies the name for the tag. The name must be unique in the tag group. The maximum text amount of the name is 48 characters. Chinese characters are supported. The name cannot start with a number, and cannot be the same as a macro keyword. The name of global tags must start with underscore (_). The name of the local tags cannot start with underscore (_).
Data Type		Selects the data type for the tag from the dropdown list. The supported data types for each tag are the following: 16-Bit Unsigned Integer, 32-Bit Unsigned Integer, 16-Bit Signed Integer, 32-Bit Signed Integer, 16-Bit BCD, 32-Bit BCD, 32-Bit Floating Point, ASCII String, Bit.
Address	<Edit Box>	Specifies the bit address when the Data Type is Bit, otherwise specifies the word address.
		Click this icon to bring up the Address Input Keypad and specify the desired address for the <Edit Box> field.
Length		Specifies the string length when the Data Type is ASCII string, otherwise displays n/a
Scan Rate		Selects the scan rate for the tag from the dropdown list. The supported scan rates for each tag are Fast and Normal.
Comment		Type a comment for the tag.

- Cut, copy, paste and delete selected tags using menu commands or key combinations.

You can right-click the number column to display a pop-up menu of editing commands. The editing commands available vary depending on what is selected.

The following table shows the supported editing commands.

Menu Command	Key Combination	Description
Cut	CTRL+X	Removes selected tags from the active window and saves them to the Clipboard.
Copy	CTRL+C	Duplicates selected tags in the active window.
Paste	CTRL+V	Pastes cut or copied tags into an active window.
Delete	DELETE	Deletes tags without copying it to the Clipboard.

Note that all editing commands require a selection in order to work. To select a tag, click the row on its header number column. To select multiple tags, click the row on its header column and use Ctrl+Click to add a row to the selection.

2.3.4. Importing and Exporting Tags

■ Importing Tags

- 1) Right-click the Internal Memory, a link, or any tag groups item in the Tag Group Explorer to bring out the pop-up menu. Then use the Import Tags... command on the pop-up menu.
- 2) Click the *.csv file you want to import. If you want to open a tags import file that is saved in a different folder, locate and open the folder first.
- 3) Click Open.

Note: If the file format is not correct, the import operation will be cancelled.

Note: The tags import file can contain tags only, or many tag groups and their tags.

Note: If the name of a tag already exists in the tag group, you will be asked to confirm whether to replace the existing tag or not.

- If Yes, the tag in the tag group will be replaced by the tag from the file.
- If No, only the tag with nonexistent names will be imported.
- If Cancel, the import operation will be cancelled.

Note: If the tag group name already exists, you will be asked to confirm whether to replace the existing tag group or not.

- If Yes, the tags in the existing tag group will be removed and replaced by the tags from the file.
- If No, only the tag group with nonexistent name and its tags will be imported.
- If Cancel, the import operation will be cancelled.

■ Exporting Tags

If you have tags you want to reuse in another application panel, export the tags of the selected tag group as a .csv file. You may do the following:

- 1) Locate the tag group you would like to export.
- 2) Right-click on the tag group to display the pop-up menu; and then click Export Tags...
- 3) If you want to save tags in a different folder, locate and open the folder first, then click Save.

You can export all the tags of the internal memory as a .csv file by right-clicking on the internal memory and then using the Export All Tags command on the pop-up menu.

2.3.5. Adding/Deleting/Renaming Tag Groups

■ Adding a Tag Group

- 1) Click the internal memory you want to add a tag group for.
- 2) Right-click the selected item to display the pop-up menu, and then click Add Group.
- 3) The new tag group will be added, and the default tag group name will become selected for renaming.

■ Deleting a Tag Group:

- 1) Locate the tag group you would like to delete.
- 2) Right-click on the tag group to display the pop-up menu, and then click Delete Group.

Note: You can only select one tag group to delete at one time.

■ Renaming a Tag Group:

- 1) Locate the tag group you would like to rename.
- 2) Right-click on the tag group to display the pop-up menu, and then click Rename Group or click the tag group.
- 3) The tag group name will become selected. Simply type the new name over the selected text, and then press the ENTER key or click anywhere outside the editing field.

CHAPTER 3





CREATING PANEL APPLICATIONS

3.1. Setting up the Panel Application.....	1
3.1.1. General Settings.....	2
3.1.2. Custom Settings.....	5
3.1.3. Activating Multiple Overlapped Buttons by One Touch.....	7
3.1.4. Specifying Default Folder for PC Based File I/O.....	8
3.2. Working with Keys.....	10
3.2.1. Default Settings for the Panel Application.....	11
3.2.2. Settings for a Screen.....	12
3.2.3. Key Usage Table Settings.....	13
3.2.4. Usage Settings for a Key.....	14
3.3. Internal Memory.....	18
3.3.1. Types of Internal Memory.....	18
3.3.2. Index Registers.....	18
3.3.3. System Memory.....	19
3.3.4. Setting up Internal Memory.....	21
3.4. Communication Links.....	22
3.4.1. Types of Communication Links.....	22
3.4.2. General Settings.....	26
3.4.3. Parameter Settings (Serial Port).....	29
3.4.4. Parameter Settings (Ethernet Port).....	30
3.4.5. Sub-link Settings.....	31
3.4.6. Sharing Data among Panels Using Data Sharer.....	32
3.4.7. Writing Communication Programs Using Macro Commands.....	33
3.4.8. Using Gateway Server of the Target Panel.....	37
3.5. Sound Table.....	40
3.6. Command Block and Status Words.....	42
3.6.1. Types of Command Block and Status Words.....	42
3.6.2. General Settings.....	47
3.6.3. Command Block Settings (Type A).....	48

3.6.4.	Status Word Settings (Type A).....	51
3.6.5.	Command Block Settings (Type H).....	52
3.6.6.	Status Word Settings (Type H)	54
3.6.7.	Using General Commands.....	55
3.7.	Setting up Clock Operations	57
3.8.	Setting up Passwords.....	60
3.9.	Screens	61
3.9.1.	Types of Screens	61
3.9.2.	Creating and Opening Screens.....	62
3.9.3.	Setting up a Screen	63
3.9.4.	Importing/Exporting a Screen.....	68
3.9.5.	Cutting/Copying/Pasting/Deleting a Screen.....	68
3.9.6.	Saving Screens as Pictures.....	69

3.1. Setting up the Panel Application

You can set up the panel application with the General Setup dialog box. There are five ways to open the dialog box:

- 1) In the Project Manager window, double-click the panel application node ().
- 2) In the Project Manager window, right-click the panel application node () to bring up the pop-up menu and select General Setup.
- 3) In the Project Manager window, double-click the General Setup node () under Setup node of the panel application
- 4) In the Project Manager window, right-click the General Setup node () under Setup node of the panel application to bring out the pop-up menu and select Properties.
- 5) In the menu bar, click Panel | Setup | General Setup....

The General Setup dialog box contains the following pages. Some of the pages appear only when they are needed.

- **General**

Described in [Section 3.1.1.](#)

- **Custom**

Described in [Section 3.1.2.](#)

- **Keys**

Described in [Section 3.2.1.](#)

- **Startup Macro / Main Macro / Event Macro / Time Macro**

Described in [Section 14.2.6.](#)

3.1.1. General Settings

This section describes how to define the general settings for a panel application. The following is an example of the General page of the General Setup dialog box.

The screenshot shows the 'General Setup' dialog box with the following settings:

- Application Name:** xxx104
- Model:** xxx 104-VNT (Ethernet)
- Battery Backed RAM:** 128 KB
- Flash ROM:** Standard
- Start Up:**
 - Screen: 25 Operator
 - Delay Time: 3 second(s) Display Countdown
 - Language: English
 - Login Required Default User Level: 8
- Idle Processing:**
 - Display Idle Screen Idle Time: 60 minutes
 - Idle Screen: 30 Screen Saver
 - Change User Level Idle User Level: 0
 - Screen Saver Time: 8 minutes
- Buzzer Sounding Time:** 0.5 seconds
- Macro:**
 - Startup Macro
 - Main Macro Delay Time: 250 milli-second(s)
 - Event Macro #1: Trigger bit: #0
 - Event Macro #2: Trigger bit: #5
 - Event Macro #3: Trigger bit: #7
 - Event Macro #4:
 - Time Macro #1: Time Interval: 0.5 second
 - Time Macro #2: Time Interval: 15 seconds
 - Time Macro #3: Time Interval: 10 minutes
 - Time Macro #4: Time Interval: 8 hours
- Print:**
 - Printer: Siupo SP Series (COM: 9600,8,E,1)
 - Port: COM1
- Overlapped buttons can be activated in sequence by one touch
- Note:** This is an example.

Buttons: OK, Cancel, Help

The following table describes each item in the General page.

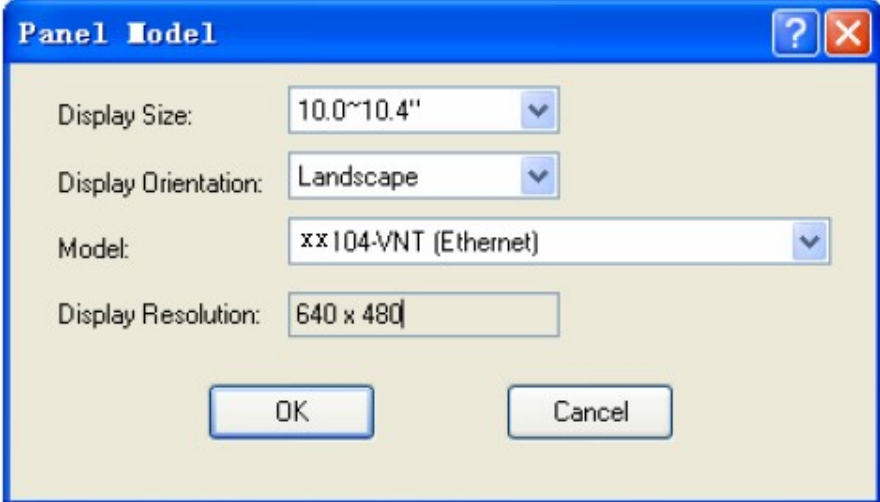
Item		Description
Application Name		The name of the panel application.
Model		<p>The model of the target panel.</p> <p>Click  to bring up the Panel Model dialog box which helps you to select a model by specifying the size, resolution and orientation of the display.</p> <p>The following is a sample of Panel Model dialog box</p> 
Battery Backed RAM		Specifies the size of the battery backed RAM installed in the target panel.
Flash ROM		Specifies the size of the flash ROM installed in the target panel.
Use External Keypad		Available if the target panel supports the custom designed external keypad. Select this option if the application uses a custom designed external keypad.
Start Up	Screen	Specifies the first screen of the application that the target panel will display after powering up.
	Delay Time	Specifies the time that the target panel will delay to run the application.
	Display Countdown	Check this option if you want the target panel to display countdown while it is waiting for the expiry of the Delay Time.
	Language	Specifies the language the application will display the text in after power up.
	Login Required	Check this option if you want the target panel to get a valid password from the operator before it displays the first screen.
	Default User Level	Available when Login Required is not selected. Specifies the initial user level for the application.
Idle Processing	Display Idle Screen	Check this option to display the Idle Screen when the target panel has idled for the specified amount of time.
	Idle Time	The length of time used to determine when the idle screen is displayed.
	Idle Screen	Specifies the screen that will be displayed as the idle screen.
	Change User Level	Check this option to change the current user level when the idle screen is displayed.
	Idle User Level	Available when the Change User Level is selected. Specifies the user once the idle screen is displayed.
	Screen Saver Time	Specifies the screen saver time. The target panel will turn off its backlight when it has not been operated by the operator for the specified amount of time.

Continued

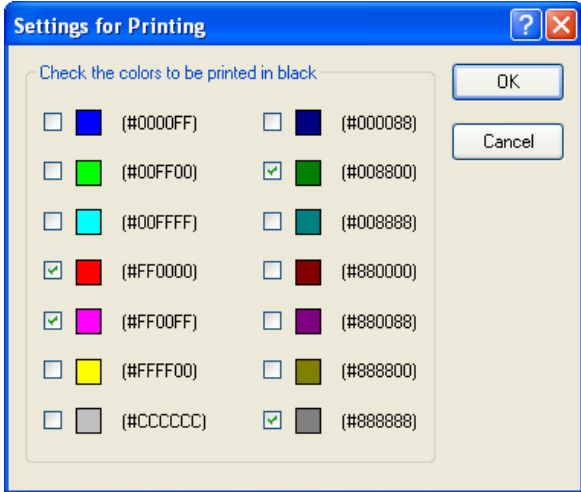
Item		Description														
Buzzer Sounding Time		Specifies the length of the beep sounded by the buzzer when a touch operation is activated.														
Overlapped buttons can be activated in sequence by one touch		Check this option if you want the application to have the overlapped buttons can be activated in sequence by one touch feature. This allows the operator to issue multiple data settings or commands with one touch. There are some constraints with using this feature. See Section 3.1.3 for details.														
Note		You can type a note for the panel application.														
Macro	Startup Macro	Check this item if you want the application to have the Startup macro. The Startup macro is only run once when the application starts. The target panel will not display the start-up screen until the macro terminates. You can use Startup macro to initialize global data and settings for your application.														
	Main Macro	Check this item if you want the application to have the Main macro. The Main macro runs concurrently with the application. The target panel runs the Main macro cyclically, i.e. it will delay preset time to run Main macro starting from the first command each time after processing the last command of the macro, or when it encounters an END command in the middle of the macro.														
	Event Macro #1~#4	An Event macro is run whenever the associated trigger bit changes from 0 (Off) to 1 (On). An application can have up to four Event macros. If the application needs an Event macro for a certain event, check one of the items that are available and specify the associated trigger bit for the corresponding Event macro.														
	Time Macro #1~#4	<p>A Time macro is run periodically with a preset time interval. An application can have up to four Time macros. Each Time macro has a different set of time intervals that can be chosen to specify how often it runs. The following table describes the available time intervals for each Time macro.</p> <table border="1"> <thead> <tr> <th>Time Macro</th> <th>Available Time Intervals</th> <th>Remark</th> </tr> </thead> <tbody> <tr> <td>#1</td> <td>0.5 and 1 second</td> <td></td> </tr> <tr> <td>#2</td> <td>1, 2, 3, ... and 59 seconds</td> <td></td> </tr> <tr> <td>#3</td> <td>1, 2, 3, ... and 59 minutes</td> <td>The macro is run at 0 second.</td> </tr> <tr> <td>#4</td> <td>1, 2, 3, ... and 24 hours</td> <td>The macro is run on the clock.</td> </tr> </tbody> </table> <p>If the application needs a Time macro, check the item of an appropriate Time macro and specify the time interval for that Time macro.</p>	Time Macro	Available Time Intervals	Remark	#1	0.5 and 1 second		#2	1, 2, 3, ... and 59 seconds		#3	1, 2, 3, ... and 59 minutes	The macro is run at 0 second.	#4	1, 2, 3, ... and 24 hours
Time Macro	Available Time Intervals	Remark														
#1	0.5 and 1 second															
#2	1, 2, 3, ... and 59 seconds															
#3	1, 2, 3, ... and 59 minutes	The macro is run at 0 second.														
#4	1, 2, 3, ... and 24 hours	The macro is run on the clock.														
Print	Printer	Specifies the type of printer that the application will use.														
	Port	Specifies the port of the target panel that will connect to the printer.														
		<p>If the printer is a mono printer, you can click it to bring up the “Settings for Printing” dialog box which helps you to select the colors to be printed in black. The following is a sample of Settings for Printing dialog box.</p> 														

3.1.2. Custom Settings

This section describes how to define the customization settings for a panel application. The following is an example of the Custom page of the General Setup dialog box.

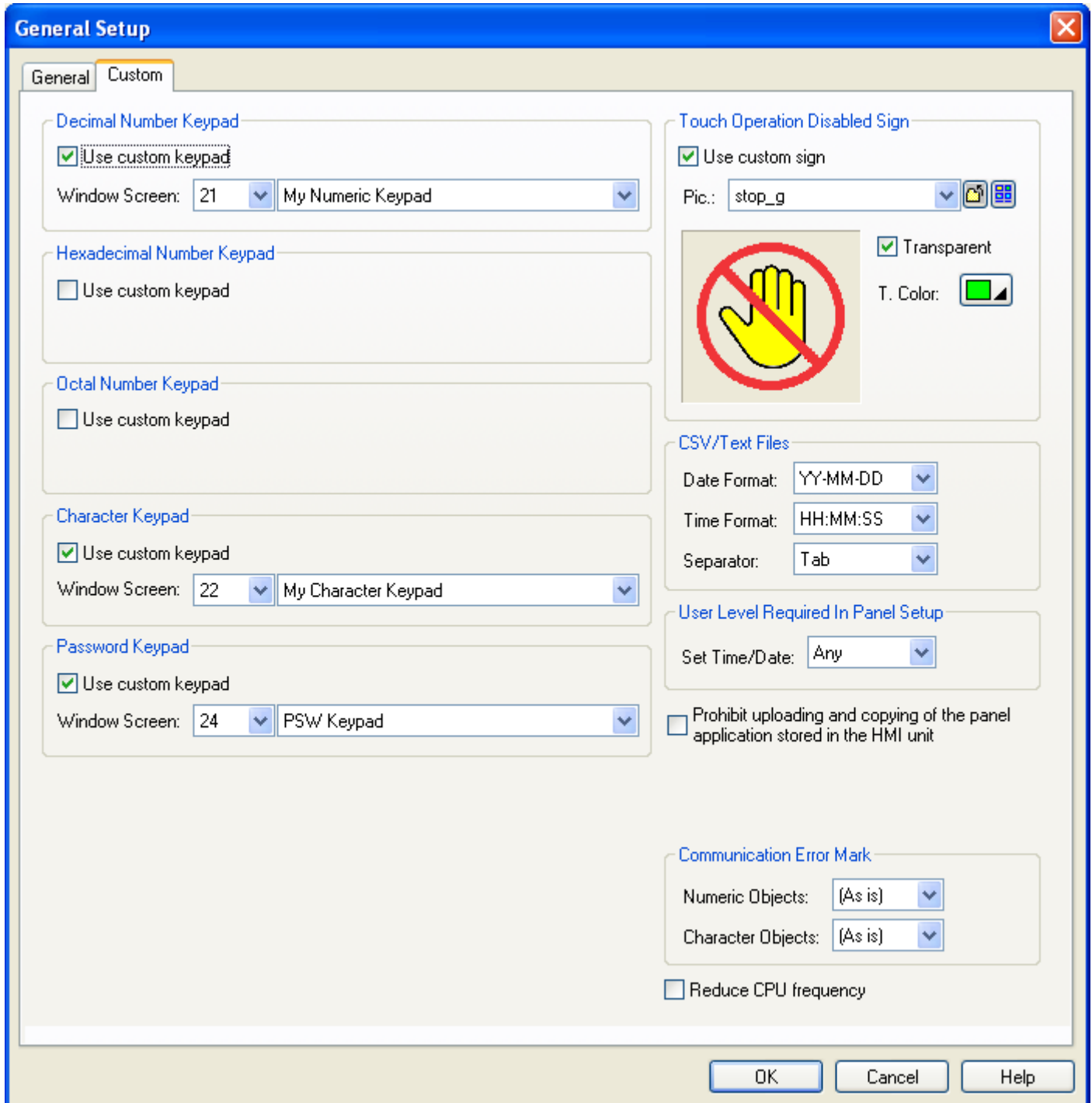

The following table describes each item in the Custom page.

Item		Description										
Decimal Number Keypad	Use custom keypad	Check this item if you want the application to use the custom keypad instead of the built-in keypad for the entry of decimal numbers.										
	Window Screen	Specify the window screen that is designated as the decimal number keypad.										
Hexadecimal Number Keypad	Use custom keypad	Check this item if you want the application to use the custom keypad instead of the built-in keypad for the entry of hexadecimal numbers.										
	Window Screen	Specify the window screen that is designated as the hexadecimal number keypad.										
Octal Number Keypad	Use custom keypad	Check this item if you want the application to use the custom keypad instead of the built-in keypad for the entry of octal numbers.										
	Window Screen	Specify the window screen that is designated as the octal number keypad.										
Character Keypad	Use custom keypad	Check this item if you want the application to use the custom keypad instead of the built-in keypad for the entry of characters.										
	Window Screen	Specify the window screen that is designated as the character keypad.										
Password Keypad	Use custom keypad	Check this item if you want the application to use the custom keypad instead of the built-in keypad for the entry of passwords.										
	Window Screen	Specify the window screen that is designated as the password keypad.										
Default Folder for File I/O		This field is available only for Windows-based panels. There are 4 kinds of default folder that you can select for your application. They are Same as Application File, Pre-assigned, New Per Day, New Per Month. Please see Section 3.1.4 for details										
Touch Operation Disabled Sign	Use custom sign	Check this item if you want the application to display the custom sign instead of the built-in sign when the touch operation of an object is disabled.										
	Picture	Specify the picture that is to replace the built-in sign.										
	Transparent	Select this item if you want parts of the custom sign to be transparent.										
	T. Color	Specify the transparent color.										
CSV/Text Files	Date Format	The date format that the target panel will use to output date information to text files.										
	Time Format	The time format that the target panel will use to output time information to text files.										
	Separator	Select desired delimiter that can be TAB, semicolon, or comma of CSV files.										
User Level Required in Panel Setup	Set Time/Date	The minimum user level that is required to set the time and date of the target panel through the target panel's Panel Setup menu.										
Prohibit uploading and copying of the panel application stored in the HMI unit		Check this option if you want to prohibit uploading and copying of the panel application stored in the HMI unit.										
Communication Error Mark		Specify what to display for the Numeric Objects (including Numeric Entry and Numeric Display) and Character Objects (including Character Entry and Character Display) when their monitored data are unavailable due to communication errors. You can select the following options as the error mark.										
		<table border="1"> <thead> <tr> <th>Mark</th> <th>Description</th> </tr> </thead> <tbody> <tr> <td>(As is)</td> <td>No communication error mark for the object. Leaves the display unchanged.</td> </tr> <tr> <td>(Blank)</td> <td>Clears the display of the object.</td> </tr> <tr> <td>?</td> <td>Displays a string of character '?'. </td> </tr> <tr> <td>#</td> <td>Display a string of character '#'. </td> </tr> </tbody> </table>	Mark	Description	(As is)	No communication error mark for the object. Leaves the display unchanged.	(Blank)	Clears the display of the object.	?	Displays a string of character '?'.	#	Display a string of character '#'.
Mark	Description											
(As is)	No communication error mark for the object. Leaves the display unchanged.											
(Blank)	Clears the display of the object.											
?	Displays a string of character '?'.											
#	Display a string of character '#'.											

3.1.3. Activating Multiple Overlapped Buttons by One Touch

To enable the feature of activating multiple overlapped buttons by one touch, open the Panel General Setup dialog box and check the option of “Activate multiple overlapped buttons by one touch” on the General page. With this feature, the overlapped underlying buttons will be activated sequentially from top to bottom when the top-most button is pressed. The following are the constraints of applying this feature.

1. The types of buttons that support this feature include: Bit Button, Toggle Switch, Screen Button, Function Button, Word Button, Multi-state Switch, and Keypad Button.
2. The first button, i.e. the top-most button, can only be a bit button, a toggle switch, a word button, a multi-state switch, or a keypad button. The button cannot have the optional property of Minimum Hold Time or Operator Confirmation. If the button is a bit button, a toggle switch, or a keypad button, it cannot have any macro. If the button is a word button, it cannot be configured for Enter Value or Enter Password. If the button is a multi-state switch, it cannot be configured as a List or Drop-down List.
3. The underlying buttons that have the optional property of Minimum Hold Time or Operator Confirmation will not be activated.
4. An underlying bit button that is configured for Momentary ON or Momentary OFF will not be activated. However, if that bit button is the second button and the first button is a keypad button, it can be activated. An underlying bit button that has any macro will not be activated.
5. An underlying toggle switch that has any macro will not be activated.
6. An underlying multi-state switch that is configured as a List or Drop-down List will not be activated.
7. A function button can only be the last button, i.e. the bottom-most button. All the buttons that are under a function button will not be activated.
8. A screen button can only be the last button. All the buttons that are under a screen button will not be activated.
9. A word button that is configured for Enter Value or Enter Password can only be the last button. All the buttons that are under such a button will not be activated.
10. The maximum number of buttons that can be indirectly activated by one touch is 10.

3.1.4. Specifying Default Folder for PC Based File I/O

The default folder will be used for a file I/O operation when one of the following two conditions exists:

- 1) The command issued for the operation does not require a specific filename.
- 2) The command issued for the operation requires a filename and the specified filename contains no path information.

To specify the default folder, access the “Custom” page of the “Panel General Setup” dialog box. Select “General Setup” and “Panel” in the submenu to get the dialog box, then click the “Custom” tab. Another way to access the dialog box is to double-click the “Panel General Setup” node on the project tree.

On the “Custom” page, you can specify the desired default folder in the “Default Folder for File I/O” group according to the following rules:

- 1) If you want the folder of your application file (.pe2 or .pl2 file) to be the default folder, select “Same as Application File” in the “Option” combo box.

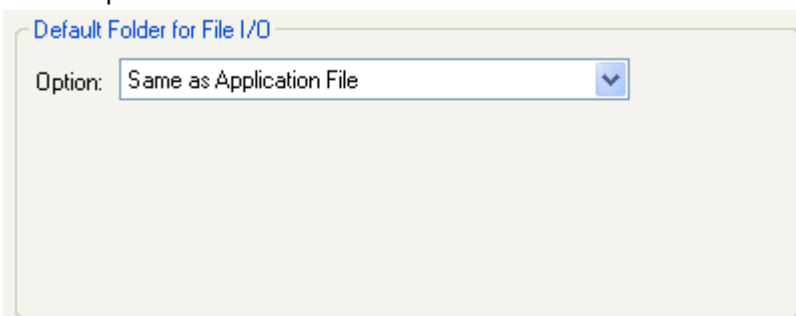

The screenshot shows a dialog box titled "Default Folder for File I/O". It contains a single control labeled "Option:" with a dropdown menu. The dropdown menu is currently set to "Same as Application File".

For applications with this selection running on HMI units, because the applications are not stored in any file or under any directory, the root directory of the USB memory stick will be used as the default folder instead.

- 2) If you want to use a specific folder that will exist at run-time as the default folder, select “Pre-assigned” in the “Option” combo box and specify the folder in the “Folder” edit box.

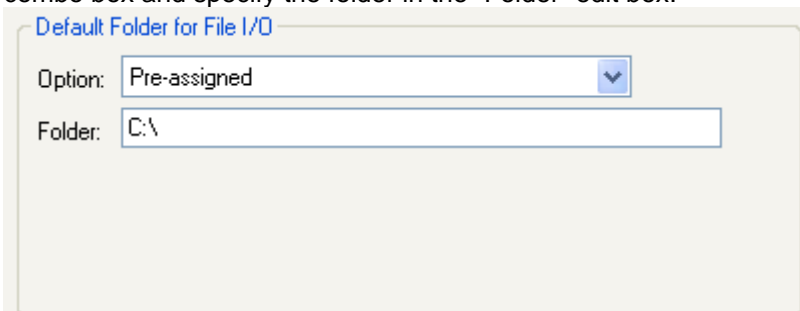

The screenshot shows the same dialog box titled "Default Folder for File I/O". The "Option:" dropdown menu is now set to "Pre-assigned". Below it, there is a text input field labeled "Folder:" containing the text "C:\".

Note that the specified folder must exist at run-time or the file I/O operations will fail.

- 3) If your application needs a new default folder every day, select “New Per Day” in the “Option” combo box, and specify the following 3 items:
- Folder Path: The path for the new folder. The system will create a new default folder under the specified path every day.
 - Folder Name Format: The format to create a default folder name.
 - <Prefix>: The string to be used as the prefix of the new default folder names. Note that only ASCII characters are allowed.

Default Folder for File I/O

Option:

Folder Path:

Folder Name Format:
 e.g.: C:\081231

Example:

Folder Name Format	Folder Path	<Prefix>	Date	Default Folder Name
<Prefix>yymmdd	C:	ABC	December 19, 2008	C:\ABC081219
<Prefix>yyymmdd	D:\NEO	ABC_	December 19, 2008	D:\NEOABC_20081219
<Prefix>yyMMMdd	C:	XYZ	January 10, 2009	C:\XYZ09JAN10
<Prefix>yyyyMMMdd	D:\123	XYZ_	January 10, 2009	D:\123XYZ_2009JAN10

- 4) If your application needs a new default folder every month, select “New Per Month” in the “Option” combo box and specify the following 3 items:
- Folder Path: The path for the new folder. The system will create a new default folder under the specified path every month.
 - Folder Name Format: The format to create a default folder name.
 - <Prefix>: The string to be used as the prefix of the new default folder names. Note that only ASCII characters are allowed.

Default Folder for File I/O

Option:

Folder Path:

Folder Name Format:
 e.g.: C:\0812

Example:

Folder Name Format	Folder Path	<Prefix>	Date	Default Folder Name
<Prefix>yymm	C:	ABC	December 19, 2008	C:\ABC0812
<Prefix>yyymm	D:\NEO	ABC_	December 19, 2008	D:\NEOABC_200812
<Prefix>yyMMM	C:	XYZ	January 10, 2009	C:\XYZ09JAN
<Prefix>yyyyMMM	D:\123	XYZ_	January 10, 2009	D:\123XYZ_2009JAN

3.2. Working with Keys

Some of the target panels are key type. Those key type panels carry external keys that you can press to perform the defined operations.

To assign or change the operation of the keys in the panel application, you can use the following two ways:

- **Default Settings for the Panel Application**
Described in [Section 3.2.1.](#)
- **Settings for a Screen**
Described in [Section 3.2.2.](#)

3.2.1. Default Settings for the Panel Application

The default settings are settings that can be used by all screens in the panel application. With the default settings of the keys, all the screens in the panel application can share the common usages of keys and do not have to keep and maintain the same usages in each screen.

You can change the default settings of keys for the panel application in the General Setup property sheet. To open the General Setup property sheet, please see [Section 3.1 Setting up the Panel Application](#) for details. The General Setup property sheet provides you with the Keys page to set up the default keys.

The following is an example of the Keys page and Usage Setup dialog in the General Setup property sheet.

The screenshot shows the 'General Setup' dialog box with the 'Keys' tab selected. It contains a 'Key Usage Table' and a 'Usage Setup Dialog' for key K22.

Key	Usage	Usage(Esc +)
UP	None	None
DOWN	None	None
F1	None	None
F2	None	None
F3	None	None
F4	None	None
F5	None	None
F6	None	None
K20	None	None
K21	None	None
K22	Bit Button	None
K23	None	None
K24	None	None
K25	None	None
K26	None	None
K27	None	None
K30	None	None
K31	None	None
K32	None	None

The 'Usage Setup Dialog' for K22 shows the following configuration:

- Usage: Bit Button
- Function: Invert
- Write Address: 1\M238
- Advanced options:
 - Enabled by Bit
 - Enabled by User Level
 - Operator Confirmation
 - Notification

If all the screens use the default settings of the key named K22, the K22 key will perform just like the bit button when it is pressed. That means in any screen at runtime, the state of 1\M238 bit will be inverted when the K22 Key is pressed.

There are two parts in the above illustration: Key Usage Table and Usage Setup Dialog.

■ Key Usage Table

A table lists all the keys of the target panel and their default usages. The key usage table is initially empty (Usages for key and key combination are none) after the panel application is created. For details about Key Usage Table, please see [Section 3.2.3](#)

■ Usage Setup Dialog

A floating dialog box allows you to specify the usage of the selected key or key combination. Left-click the cell in the key usage table to bring up the dialog. For details about Usage Setup Dialog, please see [Section 3.2.4](#).

3.2.2. Settings for a Screen

Each screen can have its own key operation. You can allow a key to perform an operation only in the specified screen by changing the settings of the screen keys in the Screen Properties property sheet. To open the Screen Properties property sheet, please see [Section 3.9.3 Setting up a Screen](#) for details. The Screen Properties property sheet has the Keys page to set up the keys for the screen.

The following is an example of the Keys page and Usage Setup dialog in Screen Properties property sheet.

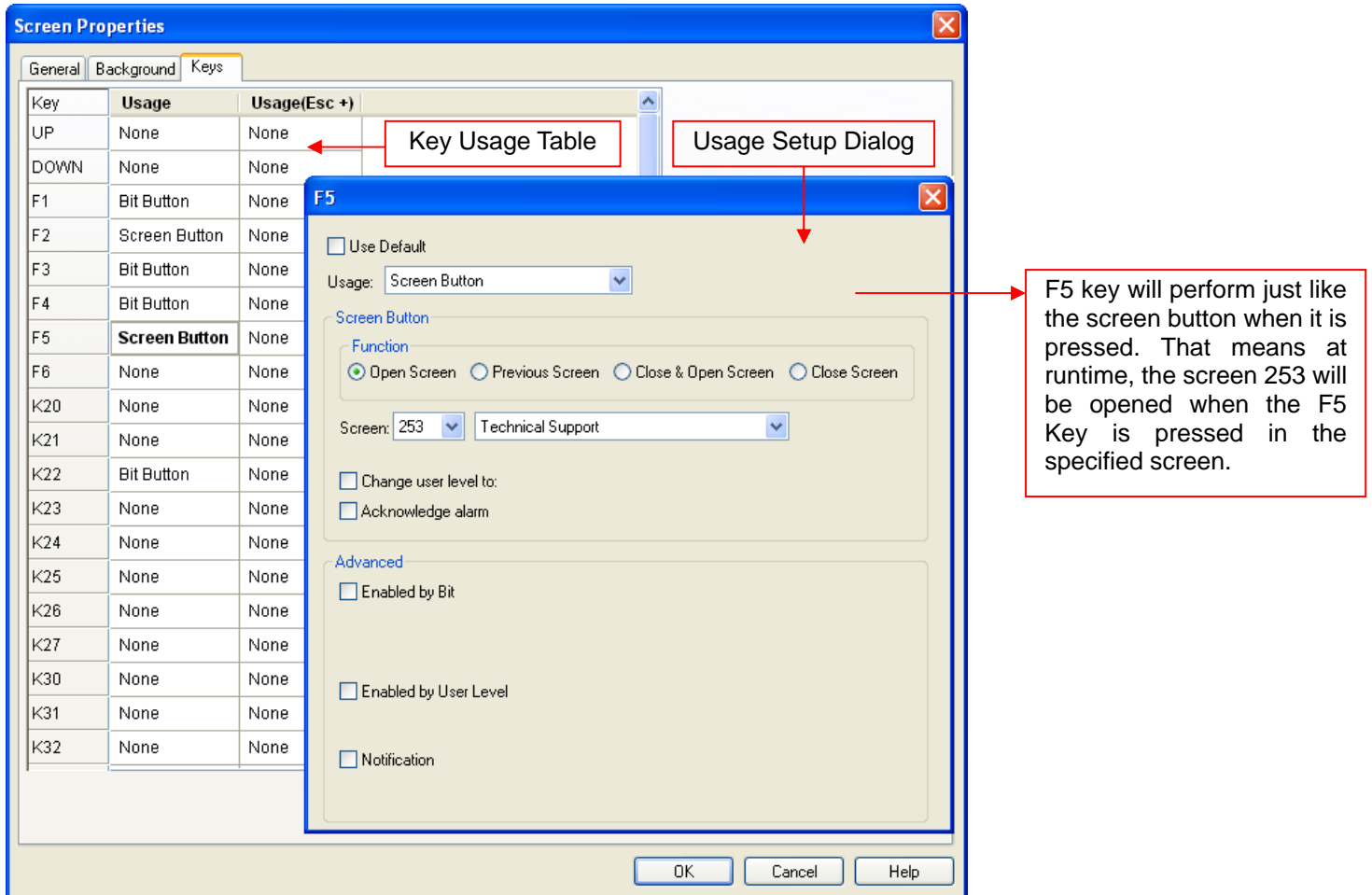

There are two parts in the above illustration: Key Usage Table and Usage Setup Dialog.

■ Key Usage Table

A table lists all the keys of the target panel and their usages. The key usage table is the same as the one in the Keys page of the General Setup property sheet when the screen is created. For details about Key Usage Table, please see [Section 3.2.3](#)

■ Usage Setup Dialog

A floating dialog box allows you to specify the usage for the selected key or key combination. Left-click the cell in the key usage table to bring up the dialog. The Use Default option is checked by default. Uncheck the Use Default option to assign a usage for the selected cell that will only be available in the specified screen. For details about Usage Setup Dialog, please see [Section 3.2.4](#).

3.2.3. Key Usage Table Settings

The key usage table is located in the Keys page of the General Setup property sheet or Screen Properties property sheet. It lists all the keys of the target panel and their default usages. The Keys page is only displayed for target panel with keypads.

The following is an example of a key usage table in the Keys page.

Key	Usage	Usage(Esc +)
UP	None	None
DOWN	None	None
F1	Bit Button	None
F2	Screen Button	None
F3	Bit Button	None
F4	Bit Button	None
F5	Screen Button	None
F6	None	None
K20	None	None
K21	None	None
K22	Bit Button	None
K23	None	None
K24	None	None
K25	None	None
K26	None	None
K27	None	None
K30	None	None
K31	None	None
K32	None	None

There are three columns in the key usage table.

Column	Description
Key	Available keys of the target panel.
Usage	Displays how the key will be used when it is pressed.
Usage (Esc+)	Displays how the key combination (ESC+Key) will be used when it is pressed. This column exists only when the target panel supports the key combination.

Note: Left-click the cell brings up the Usage Setup Dialog which sets up the usage of the selected cell. For details about Usage Setup Dialog, please see [Section 3.2.4.](#)





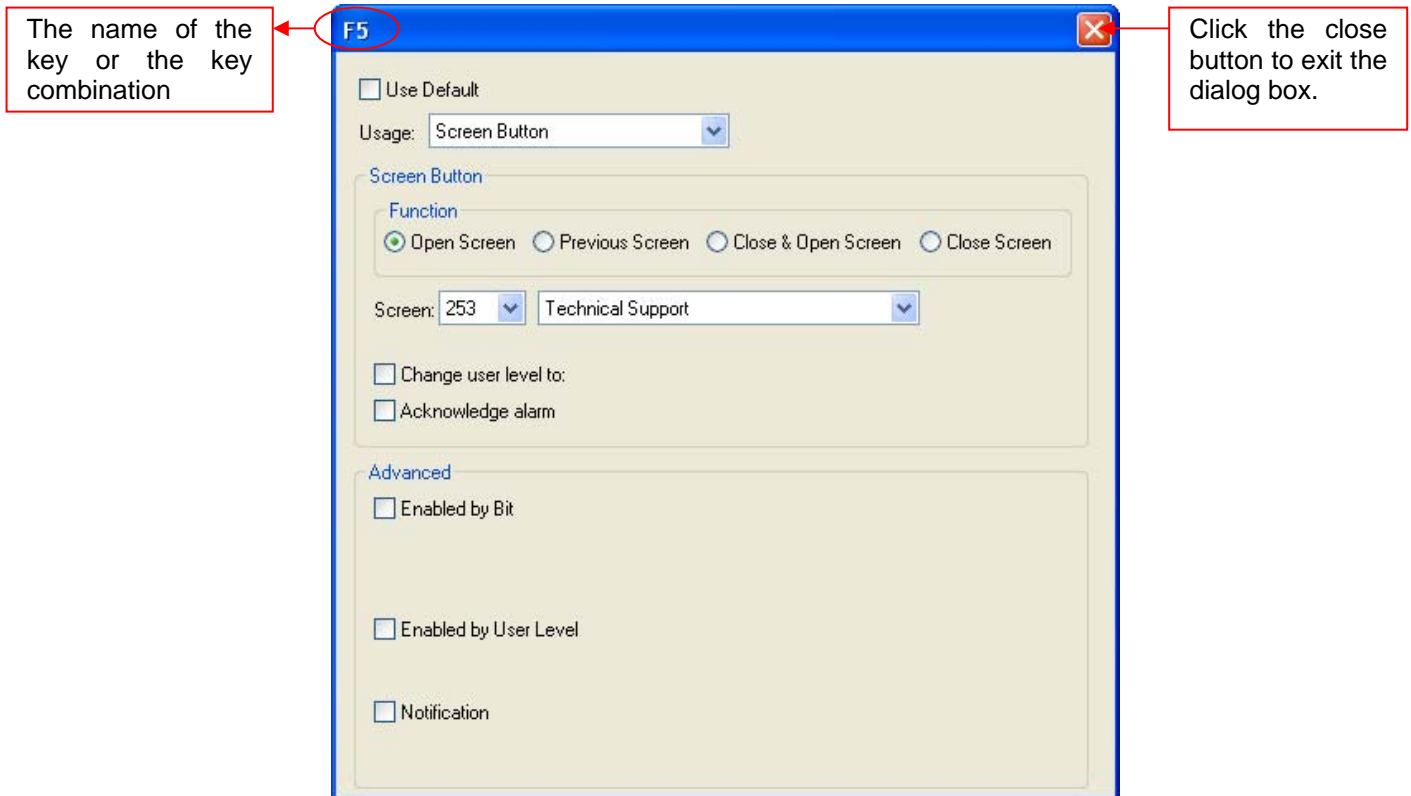

3.2.4. Usage Settings for a Key

You can assign or change the usage for the key or the key combination with the Usage Setup Dialog. The Usage Setup Dialog is a floating dialog box that can be freely moved.



To open the Usage Setup Dialog, left-click the cell in the key usage table. If the selection in the key usage table is changed, the dialog box remains open and displays the settings related to the new selection.

The following is an example of usage setup dialog.









Property	Description										
Use Default	Check this option if you want to use the default setting in the Keys page of the General Setup property sheet. The field is only available in the Keys page of the Screen Properties property sheet.										
Usage	Select a usage for the key or key combination. There are 7 options: None, Bit Button, Function Button, Keypad Button, Multistate Switch, Screen Button and Word Button.										
Bit Button	<p>If the usage is Bit Button, specify the following properties:</p> <table border="1"> <thead> <tr> <th>Property</th> <th>Description</th> </tr> </thead> <tbody> <tr> <td>Function</td> <td>Select the operation of the bit button. There are 5 options: Set ON, Set OFF, Momentary ON, Momentary OFF, and Invert. For details, see Section 5.1.1 Basic Operations</td> </tr> <tr> <td>Write Address</td> <td>Specifies the bit variable to be operated. Click  to enter an address for this field. Click  to select a tag for this field.</td> </tr> <tr> <td>ON Macro</td> <td>Check this option for the button to have an ON macro. Select a macro from the dropdown list. This option is available when the bit button operation is Set ON, Momentary ON, or Momentary OFF.</td> </tr> <tr> <td>OFF Macro</td> <td>Check this option for the button to have an OFF macro. Select a macro from the dropdown list. This option is available when the bit button operation is Set OFF, Momentary ON, or Momentary OFF.</td> </tr> </tbody> </table>	Property	Description	Function	Select the operation of the bit button. There are 5 options: Set ON, Set OFF, Momentary ON, Momentary OFF, and Invert. For details, see Section 5.1.1 Basic Operations	Write Address	Specifies the bit variable to be operated. Click  to enter an address for this field. Click  to select a tag for this field.	ON Macro	Check this option for the button to have an ON macro. Select a macro from the dropdown list. This option is available when the bit button operation is Set ON, Momentary ON, or Momentary OFF.	OFF Macro	Check this option for the button to have an OFF macro. Select a macro from the dropdown list. This option is available when the bit button operation is Set OFF, Momentary ON, or Momentary OFF.
Property	Description										
Function	Select the operation of the bit button. There are 5 options: Set ON, Set OFF, Momentary ON, Momentary OFF, and Invert. For details, see Section 5.1.1 Basic Operations										
Write Address	Specifies the bit variable to be operated. Click  to enter an address for this field. Click  to select a tag for this field.										
ON Macro	Check this option for the button to have an ON macro. Select a macro from the dropdown list. This option is available when the bit button operation is Set ON, Momentary ON, or Momentary OFF.										
OFF Macro	Check this option for the button to have an OFF macro. Select a macro from the dropdown list. This option is available when the bit button operation is Set OFF, Momentary ON, or Momentary OFF.										



Continued

Property	Description	
Function Button	If the usage is Function Button, specify the following properties:	
	Property	Description
	Function	Specifies the operation for the function button to perform. About the available operations, see Section 5.4.1 Basic Operation .
Keypad Button	If the usage is Keypad Button, specify the following properties:	
	Property	Description
	Enter Character	Select this item if the button is used to input specified character to the keypad buffer.
	Character	Available when Enter Character is selected. Specifies the character to be entered in the keypad buffer.
	Enter Command	Select this item if the button is used to issue the specified command to the keypad buffer.
	Command	Available when the Enter Command is selected. Specifies the command issued to the keypad buffer. There are 4 commands available:
Command		Description
Enter		Completes the data entry and sends the input string to the associated object or the system.
Escape		Cancels the data entry operation.
Clear		Clears the keypad buffer.
Backspace	Removes the last character in the keypad buffer.	
Multistate Switch	If the usage is Multistate Switch, you need to specify the following properties:	
	Property	Description
	State Type	The state type of the monitored variable. There are 2 options: Value and LSB. For details, see Section 4.4.1.1 State Types
	Data Type	The data type of the variables specified in this page.
	Write Address	Specifies the variable to be controlled. Click  to enter an address for this field. Click  to select a tag for this field.
	Total State	Specifies the number of valid states that the monitored variable has. Note: The last state is state N-1 when the Total States is N.
	Next State	Specifies the method of calculating the next state. +1 means the next state is the current state plus one, when the current state is not the last state. When the current state is the last state, the next state is state 0. -1 means the next state is the current state minus one, when the current state is not state 0. When the current state is state 0, the next state is the last state.
Screen Button	If the usage is Screen Button, specify the following properties:	
	Property	Description
	Function	Specifies the operation for the screen button to perform. There are 4 options: Open Screen, Previous Screen, Close and Open Screen, and Close Screen. For details, see Section 5.3.1 Basic Operations .
	Screen	Specifies the screen to be opened.
	Change user level to	Check this option for the button to change the current user level. Specify the new user level to replace the current user level.
	Acknowledge alarm	Check this option for the button on the alarm-associated screen to acknowledge the alarm.

Continued

Property	Description																																																		
Word Button	<p>If the usage is Word Button, you need to specify the following properties:</p> <table border="1" data-bbox="293 277 1474 1525"> <thead> <tr> <th data-bbox="293 277 504 315">Property</th> <th data-bbox="504 277 1474 315">Description</th> </tr> </thead> <tbody> <tr> <td data-bbox="293 315 504 394">Function</td> <td data-bbox="504 315 1474 394">Specifies the operation that the word button performs. For details, see Section 5.6.1 Basic Operations.</td> </tr> <tr> <td data-bbox="293 394 504 432">Data Type</td> <td data-bbox="504 394 1474 432">The data type of the variable to be controlled.</td> </tr> <tr> <td data-bbox="293 432 504 562">Write Address</td> <td data-bbox="504 432 1474 562">Specifies the variable to be controlled. Click  to enter an address for this field. Click  to select a tag for this field.</td> </tr> <tr> <td data-bbox="293 562 504 600">Constant</td> <td data-bbox="504 562 1474 600">The constant for the specified operation.</td> </tr> <tr> <td data-bbox="293 600 504 638">Minimum</td> <td data-bbox="504 600 1474 638">The minimum for the specified operation.</td> </tr> <tr> <td data-bbox="293 638 504 676">Maximum</td> <td data-bbox="504 638 1474 676">The maximum for the specified operation.</td> </tr> <tr> <td data-bbox="293 676 504 754">Total Digits</td> <td data-bbox="504 676 1474 754">The number of digits to be displayed for the Minimum and the Maximum on the numeric keypad.</td> </tr> <tr> <td data-bbox="293 754 504 1420">Fractional Digits</td> <td data-bbox="504 754 1474 1420"> <p>When the Data Type is 32-bit Floating Point, this property specifies the number of fractional digits to be displayed for the Minimum and the Maximum on the numeric keypad.</p> <p>When the Data Type is not 32-bit Floating Point, this property specifies not only the number of fractional digits to be displayed, but also the number of least significant digits to be displayed as the fractional part. With this feature, an integer can be shown and entered as a fixed point number. When the Fractional Digits is nonzero, say N, the entered value will be converted to an integer according to the following formula before being output.</p> <p>OutputValue = EnteredValue * (Nth power of 10)</p> <p>Example:</p> <table border="1" data-bbox="517 1122 1442 1406"> <thead> <tr> <th data-bbox="517 1122 836 1196">Display Type</th> <th data-bbox="836 1122 983 1196">Total Digits</th> <th data-bbox="983 1122 1150 1196">Fractional Digits</th> <th data-bbox="1150 1122 1297 1196">Entered Value</th> <th data-bbox="1297 1122 1442 1196">Output Value</th> </tr> </thead> <tbody> <tr> <td data-bbox="517 1196 836 1234">32-bit Floating Point</td> <td data-bbox="836 1196 983 1234">4</td> <td data-bbox="983 1196 1150 1234">2</td> <td data-bbox="1150 1196 1297 1234">12.34</td> <td data-bbox="1297 1196 1442 1234">12.34</td> </tr> <tr> <td data-bbox="517 1234 836 1272">32-bit Floating Point</td> <td data-bbox="836 1234 983 1272">4</td> <td data-bbox="983 1234 1150 1272">2</td> <td data-bbox="1150 1234 1297 1272">123.4</td> <td data-bbox="1297 1234 1442 1272">Error!</td> </tr> <tr> <td data-bbox="517 1272 836 1310">16-bit Signed Decimal</td> <td data-bbox="836 1272 983 1310">5</td> <td data-bbox="983 1272 1150 1310">2</td> <td data-bbox="1150 1272 1297 1310">123.45</td> <td data-bbox="1297 1272 1442 1310">12345</td> </tr> <tr> <td data-bbox="517 1310 836 1348">16-bit Signed Decimal</td> <td data-bbox="836 1310 983 1348">5</td> <td data-bbox="983 1310 1150 1348">2</td> <td data-bbox="1150 1310 1297 1348">-0.05</td> <td data-bbox="1297 1310 1442 1348">-5</td> </tr> <tr> <td data-bbox="517 1348 836 1406">16-bit Signed Decimal</td> <td data-bbox="836 1348 983 1406">5</td> <td data-bbox="983 1348 1150 1406">2</td> <td data-bbox="1150 1348 1297 1406">3</td> <td data-bbox="1297 1348 1442 1406">300</td> </tr> </tbody> </table> </td> </tr> <tr> <td data-bbox="293 1420 504 1525">Activation</td> <td data-bbox="504 1420 1474 1525">Select Button Down item so the touch operation will be activated when the button is touched. Select Button Up item so the touch operation will be activated when the button is released.</td> </tr> </tbody> </table>	Property	Description	Function	Specifies the operation that the word button performs. For details, see Section 5.6.1 Basic Operations .	Data Type	The data type of the variable to be controlled.	Write Address	Specifies the variable to be controlled. Click  to enter an address for this field. Click  to select a tag for this field.	Constant	The constant for the specified operation.	Minimum	The minimum for the specified operation.	Maximum	The maximum for the specified operation.	Total Digits	The number of digits to be displayed for the Minimum and the Maximum on the numeric keypad.	Fractional Digits	<p>When the Data Type is 32-bit Floating Point, this property specifies the number of fractional digits to be displayed for the Minimum and the Maximum on the numeric keypad.</p> <p>When the Data Type is not 32-bit Floating Point, this property specifies not only the number of fractional digits to be displayed, but also the number of least significant digits to be displayed as the fractional part. With this feature, an integer can be shown and entered as a fixed point number. When the Fractional Digits is nonzero, say N, the entered value will be converted to an integer according to the following formula before being output.</p> <p>OutputValue = EnteredValue * (Nth power of 10)</p> <p>Example:</p> <table border="1" data-bbox="517 1122 1442 1406"> <thead> <tr> <th data-bbox="517 1122 836 1196">Display Type</th> <th data-bbox="836 1122 983 1196">Total Digits</th> <th data-bbox="983 1122 1150 1196">Fractional Digits</th> <th data-bbox="1150 1122 1297 1196">Entered Value</th> <th data-bbox="1297 1122 1442 1196">Output Value</th> </tr> </thead> <tbody> <tr> <td data-bbox="517 1196 836 1234">32-bit Floating Point</td> <td data-bbox="836 1196 983 1234">4</td> <td data-bbox="983 1196 1150 1234">2</td> <td data-bbox="1150 1196 1297 1234">12.34</td> <td data-bbox="1297 1196 1442 1234">12.34</td> </tr> <tr> <td data-bbox="517 1234 836 1272">32-bit Floating Point</td> <td data-bbox="836 1234 983 1272">4</td> <td data-bbox="983 1234 1150 1272">2</td> <td data-bbox="1150 1234 1297 1272">123.4</td> <td data-bbox="1297 1234 1442 1272">Error!</td> </tr> <tr> <td data-bbox="517 1272 836 1310">16-bit Signed Decimal</td> <td data-bbox="836 1272 983 1310">5</td> <td data-bbox="983 1272 1150 1310">2</td> <td data-bbox="1150 1272 1297 1310">123.45</td> <td data-bbox="1297 1272 1442 1310">12345</td> </tr> <tr> <td data-bbox="517 1310 836 1348">16-bit Signed Decimal</td> <td data-bbox="836 1310 983 1348">5</td> <td data-bbox="983 1310 1150 1348">2</td> <td data-bbox="1150 1310 1297 1348">-0.05</td> <td data-bbox="1297 1310 1442 1348">-5</td> </tr> <tr> <td data-bbox="517 1348 836 1406">16-bit Signed Decimal</td> <td data-bbox="836 1348 983 1406">5</td> <td data-bbox="983 1348 1150 1406">2</td> <td data-bbox="1150 1348 1297 1406">3</td> <td data-bbox="1297 1348 1442 1406">300</td> </tr> </tbody> </table>	Display Type	Total Digits	Fractional Digits	Entered Value	Output Value	32-bit Floating Point	4	2	12.34	12.34	32-bit Floating Point	4	2	123.4	Error!	16-bit Signed Decimal	5	2	123.45	12345	16-bit Signed Decimal	5	2	-0.05	-5	16-bit Signed Decimal	5	2	3	300	Activation	Select Button Down item so the touch operation will be activated when the button is touched. Select Button Up item so the touch operation will be activated when the button is released.
Property	Description																																																		
Function	Specifies the operation that the word button performs. For details, see Section 5.6.1 Basic Operations .																																																		
Data Type	The data type of the variable to be controlled.																																																		
Write Address	Specifies the variable to be controlled. Click  to enter an address for this field. Click  to select a tag for this field.																																																		
Constant	The constant for the specified operation.																																																		
Minimum	The minimum for the specified operation.																																																		
Maximum	The maximum for the specified operation.																																																		
Total Digits	The number of digits to be displayed for the Minimum and the Maximum on the numeric keypad.																																																		
Fractional Digits	<p>When the Data Type is 32-bit Floating Point, this property specifies the number of fractional digits to be displayed for the Minimum and the Maximum on the numeric keypad.</p> <p>When the Data Type is not 32-bit Floating Point, this property specifies not only the number of fractional digits to be displayed, but also the number of least significant digits to be displayed as the fractional part. With this feature, an integer can be shown and entered as a fixed point number. When the Fractional Digits is nonzero, say N, the entered value will be converted to an integer according to the following formula before being output.</p> <p>OutputValue = EnteredValue * (Nth power of 10)</p> <p>Example:</p> <table border="1" data-bbox="517 1122 1442 1406"> <thead> <tr> <th data-bbox="517 1122 836 1196">Display Type</th> <th data-bbox="836 1122 983 1196">Total Digits</th> <th data-bbox="983 1122 1150 1196">Fractional Digits</th> <th data-bbox="1150 1122 1297 1196">Entered Value</th> <th data-bbox="1297 1122 1442 1196">Output Value</th> </tr> </thead> <tbody> <tr> <td data-bbox="517 1196 836 1234">32-bit Floating Point</td> <td data-bbox="836 1196 983 1234">4</td> <td data-bbox="983 1196 1150 1234">2</td> <td data-bbox="1150 1196 1297 1234">12.34</td> <td data-bbox="1297 1196 1442 1234">12.34</td> </tr> <tr> <td data-bbox="517 1234 836 1272">32-bit Floating Point</td> <td data-bbox="836 1234 983 1272">4</td> <td data-bbox="983 1234 1150 1272">2</td> <td data-bbox="1150 1234 1297 1272">123.4</td> <td data-bbox="1297 1234 1442 1272">Error!</td> </tr> <tr> <td data-bbox="517 1272 836 1310">16-bit Signed Decimal</td> <td data-bbox="836 1272 983 1310">5</td> <td data-bbox="983 1272 1150 1310">2</td> <td data-bbox="1150 1272 1297 1310">123.45</td> <td data-bbox="1297 1272 1442 1310">12345</td> </tr> <tr> <td data-bbox="517 1310 836 1348">16-bit Signed Decimal</td> <td data-bbox="836 1310 983 1348">5</td> <td data-bbox="983 1310 1150 1348">2</td> <td data-bbox="1150 1310 1297 1348">-0.05</td> <td data-bbox="1297 1310 1442 1348">-5</td> </tr> <tr> <td data-bbox="517 1348 836 1406">16-bit Signed Decimal</td> <td data-bbox="836 1348 983 1406">5</td> <td data-bbox="983 1348 1150 1406">2</td> <td data-bbox="1150 1348 1297 1406">3</td> <td data-bbox="1297 1348 1442 1406">300</td> </tr> </tbody> </table>	Display Type	Total Digits	Fractional Digits	Entered Value	Output Value	32-bit Floating Point	4	2	12.34	12.34	32-bit Floating Point	4	2	123.4	Error!	16-bit Signed Decimal	5	2	123.45	12345	16-bit Signed Decimal	5	2	-0.05	-5	16-bit Signed Decimal	5	2	3	300																				
Display Type	Total Digits	Fractional Digits	Entered Value	Output Value																																															
32-bit Floating Point	4	2	12.34	12.34																																															
32-bit Floating Point	4	2	123.4	Error!																																															
16-bit Signed Decimal	5	2	123.45	12345																																															
16-bit Signed Decimal	5	2	-0.05	-5																																															
16-bit Signed Decimal	5	2	3	300																																															
Activation	Select Button Down item so the touch operation will be activated when the button is touched. Select Button Up item so the touch operation will be activated when the button is released.																																																		

Continued

Property	Description	
Advanced	The following table describes each Advanced property. Not all properties are available for each object.	
	Property	Description
	Enabled by Bit	Check this option so the operation of the object will be enabled and disabled by the specified bit.
	Bit	Specifies the bit that enables and disables the touch operation. Click  to enter a bit address. Click  to select a bit tag.
	Enabling State	Specifies the state (On or Off) that enables the touch operation.
	Enabled by User Level	Check this item so the touch operation of the object will be enabled and disabled by the current user level.
	Lowest Enabling User Level	Specifies the lowest user level that is required to enable the touch operation.
	Operator Confirmation	Check this option if you want the operator to confirm the operation. The Confirmation box will be displayed when the object performs the operation. If the operator selects "Yes" in the Confirmation box, the operation will be performed. If the operator selects "No" or the operator does not respond within the specified time period (Maximum Waiting Time), the operation will be cancelled.
	Maximum Waiting Time	Specifies the maximum time that the object will wait for the operator's confirmation. The operation will be cancelled if the operator does not respond within this time.
	Notification	Check this option so the object will notify the specified bit after it finishes the operation.
	Bit	Specifies the bit that receives the notification.
	State	Specifies the state (On or Off) that is used for the notification.

3.3. Internal Memory

This section describes how to set up and use the internal memory for the panel application.

3.3.1. Types of Internal Memory

The following table describes the types of memory space that can exist or always exist in the internal memory.

Type	Address Format	Description
Regular user memory	Word: \$Un Bit: \$Un.b; b: 0~f	The size of this memory space is settable.
Battery backed user memory	Word: \$Nn Bit: \$Nn.b; b: 0~f	This memory space is available when the target panel is equipped with battery backed RAM. The size of this memory space is settable.
System memory	Word: \$Sn Bit: \$Sn.b; b: 0~f	This memory space keeps the system's required data and information. See Section 3.3.3 for details.
Index registers	Word: \$In Bit: \$In.b; b: 0~f	The index registers are provided to support indirect addressing. To know how to specify indirect address by using index registers, please see Section 3.3.2 for details.
Command block	Word: \$CBn Bit: \$CBn.b; b: 0~f	This memory space is allocated for storing the data read from the specified command block.

3.3.2. Index Registers

The index registers are battery backed if the panel has battery backed memory. The index registers are cleared to zero when the panel application is updated.

You can use the index registers to specify the indirect address. With the support of indirect addressing, an object or macro can be designed to access different sets of data at run time.

Examples

- 1) The word address $W[\$I30]$ is equivalent to $W2000$ when the value of $\$I30$ is 2000.
- 2) The word address $\$U[\$I0+123]$ is equivalent to $\$U223$ when the value of $\$I0$ is 100.
- 3) The bit address $\$U[\$I2].a$ is equivalent to $\$U0.a$ when the value of $\$I2$ is 0.
- 4) The word address $[\$I2]:W100$ is equivalent to $3:W100$ when the value of $\$I2$ is 3.
- 5) The bit address $[\$I0]:W[\$I1+10].f$ is equivalent to $5:W20.f$ when the values of $\$I0$ and $\$I1$ are 5 and 10 respectively.

Notes:

- 1) It is your responsibility to make sure that values in the index registers will result in valid addresses at runtime. The software has no way of checking the validity of the use of index registers.
- 2) The offset values must be a positive number, and the maximum offset value is 65535.
- 3) Only $\$I0\sim\$I15$ can be used for the node address (PLC address), and no offset value is allowed.
- 4) Make sure the PLC driver you are using supports indirect addressing.

3.3.3. System Memory

The following table lists the system maintained data and information in the system memory of the target panels that may be useful for your application.

Note that in any case do not modify the system memory for any purpose, or the system may malfunction or crash.



Address	Length	Content
\$S0~\$S25	26	Keypad input buffer for keypads \$S0: Command code for keypad display \$S1~\$S24: Null terminated ASCII character string up to 48 characters
\$S42	1	The second and minute of the current time in BCD format Bit 0~7: Second (0x00~0x59) Bit 8~15: Minute (0x00~0x59)
\$S43	1	The hour of the current time in BCD format and the RTC adjustment parameter Bit 0~7: Hour (0x00~0x23) Bit 8~15: RTC adjustment value
\$S44	1	The day and month of the current date in BCD format Bit 0~7: Day (0x01~0x31) Bit 8~15: Month (0x01~0x12)
\$S45	1	The year and the day-of-week of the current date in BCD format Bit 0~7: Year (0x00~0x99) Bit 8~15: Day of week (0x00~0x06); 0 represents Sunday
\$S46	1	The second of the current time in binary format (0~59)
\$S47	1	The minute of the current time in binary format (0~59)
\$S48	1	The hour of the current time in binary format (0~23)
\$S49	1	The one tenth of a second of the current time in binary format (0~9) 9 represents 0.9 second
\$S50	1	The date of the current day in binary format (0~30) 0 represents the first day of a month
\$S51	1	The month of the current day in binary format (0~11) 0 represents January
\$S52	1	The year of the current day in binary format (0~99)
\$S53	1	The day of week of the current day in binary format (0~6) 0 represents Sunday
\$S219	1	Current user level (0~9); 9 indicates that the user logged in with the developer password
\$S230~\$S241	12	The ASCII character string, up to 24 characters, to show the allowable input range for numeric keypads
\$S297	1	The lowest user level that can be accepted by the current password keypad. When the value is 0, any user level is accepted. When the value is 9, only the developer password is accepted.
\$S300~\$S301	2	500ms timer
\$S302~\$S303	2	1 second timer
\$S304	1	20 Hz sine wave (-1000 ~ 1000)
\$S305	1	20 Hz cosine wave (-1000 ~ 1000)
\$S306	1	20 Hz triangle wave (0~1000)

Continued

Address	Length	Content																																																								
\$S307	1	System signals \$\$S307.0: always 0 when ready \$\$S307.1: always 1 when ready																																																								
\$S315	1	System status \$\$S315.0: 1 indicates that the data in battery backed RAM is good																																																								
\$S317	1	Current language number (0~9); 0 represents language #1																																																								
\$S319	1	Status bits of USB memory sticks \$\$S319.0: Drive C (1:OK; 0:None) \$\$S319.1: Drive D (1:OK; 0:None) \$\$S319.2: Drive E (1:OK; 0:None)																																																								
\$S654	1	Link enabled bits for Link 1~16 \$\$S654.0 is for Link 1; 0: Disabled; 1: Enabled \$\$S654.1 1 is for Link 2; ... \$\$S654.f is for Link 16																																																								
\$S662~\$S677	32	Communication status words for Link 1~16 \$\$S662 is for Link 1 \$\$S663 is for Link 2 ... \$\$S677 is for Link 16 Communication Status <table border="1"> <thead> <tr> <th>Value</th> <th>Meaning</th> <th>Value</th> <th>Meaning</th> </tr> </thead> <tbody> <tr> <td>0</td> <td>OK</td> <td>13</td> <td>Invalid request</td> </tr> <tr> <td>1</td> <td>Overrun error</td> <td>14</td> <td>Device busy</td> </tr> <tr> <td>2</td> <td>Break error</td> <td>15</td> <td>Unknown error</td> </tr> <tr> <td>3</td> <td>Parity error</td> <td>16</td> <td>Link disabled</td> </tr> <tr> <td>4</td> <td>Framing error</td> <td>17</td> <td>Initialization failure</td> </tr> <tr> <td>5</td> <td>No response</td> <td>18</td> <td>Failed to send data</td> </tr> <tr> <td>6</td> <td>Unrecognized response</td> <td>19</td> <td>Failed to receive data</td> </tr> <tr> <td>7</td> <td>Timeout</td> <td>20</td> <td>Failed to open connection</td> </tr> <tr> <td>8</td> <td>Inactive CTS</td> <td>21</td> <td>Connection not ready</td> </tr> <tr> <td>9</td> <td>Checksum error</td> <td>22</td> <td>Invalid sub-link</td> </tr> <tr> <td>10</td> <td>Command rejected</td> <td>23</td> <td>Invalid COM port</td> </tr> <tr> <td>11</td> <td>Invalid address</td> <td>24</td> <td>Error</td> </tr> <tr> <td>12</td> <td>Invalid range</td> <td>255</td> <td>Uncertain</td> </tr> </tbody> </table>	Value	Meaning	Value	Meaning	0	OK	13	Invalid request	1	Overrun error	14	Device busy	2	Break error	15	Unknown error	3	Parity error	16	Link disabled	4	Framing error	17	Initialization failure	5	No response	18	Failed to send data	6	Unrecognized response	19	Failed to receive data	7	Timeout	20	Failed to open connection	8	Inactive CTS	21	Connection not ready	9	Checksum error	22	Invalid sub-link	10	Command rejected	23	Invalid COM port	11	Invalid address	24	Error	12	Invalid range	255	Uncertain
Value	Meaning	Value	Meaning																																																							
0	OK	13	Invalid request																																																							
1	Overrun error	14	Device busy																																																							
2	Break error	15	Unknown error																																																							
3	Parity error	16	Link disabled																																																							
4	Framing error	17	Initialization failure																																																							
5	No response	18	Failed to send data																																																							
6	Unrecognized response	19	Failed to receive data																																																							
7	Timeout	20	Failed to open connection																																																							
8	Inactive CTS	21	Connection not ready																																																							
9	Checksum error	22	Invalid sub-link																																																							
10	Command rejected	23	Invalid COM port																																																							
11	Invalid address	24	Error																																																							
12	Invalid range	255	Uncertain																																																							
\$S838	1	The ID of the current recipe block (0~15)																																																								
\$S839~\$S854	16	The current recipe numbers of recipe block 0~15 \$\$S839 is for recipe block 0 \$\$S840 is for recipe block 1 ... \$\$S854 is for recipe block 15																																																								

3.3.4. Setting up Internal Memory

You can use the Internal Memory dialog box to define the size of the regular user memory and the battery backed user memory. To open the Internal Memory dialog box, do one of followings:

- 1) In the Project Manager window, double-click the Internal Memory node () under Links node of the panel application.
- 2) In the Project Manager window, right-click the Internal Memory node () under Links node of the panel application to bring out the pop-up menu and select Properties.

The following is an example of the Internal Memory dialog box.

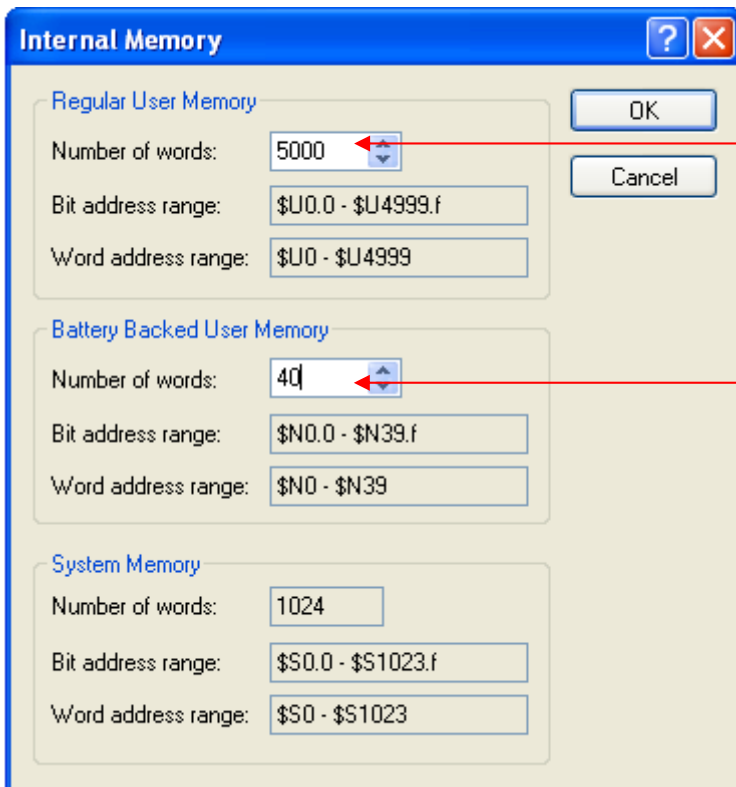

Specify the size of regular user memory. The size must be between 0 and 131072 words. By default, it is 5000.



Specify the size of battery backed user memory. The size must be between 0 and 131072 words. By default, it is 0.

3.4. Communication Links

This section describes how to set up communication links to allow the panel application to access the data of external devices.

3.4.1. Types of Communication Links

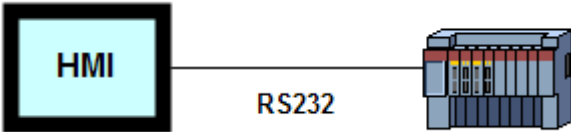
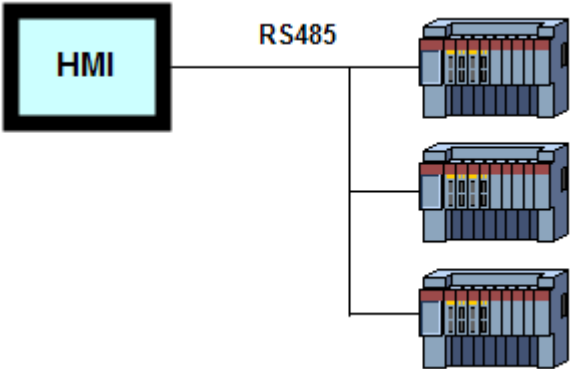
The following table describes the three types of communication links that the panel application can have.

Link Type	Description
Direct link	<p data-bbox="328 602 1497 633">Directly connects the panel with the specified device(s). The following are examples of direct links.</p> <p data-bbox="328 685 1394 716">[Example 1] The panel uses an RS232 direct link to talk with the specified device directly.</p>  <p data-bbox="328 929 1406 960">[Example 2] The panel uses an RS485 direct link to talk with the specified devices directly.</p>  <p data-bbox="328 1393 1414 1424">[Example 3] The panel uses an Ethernet direct link to talk with the specified device directly.</p> 

Continued

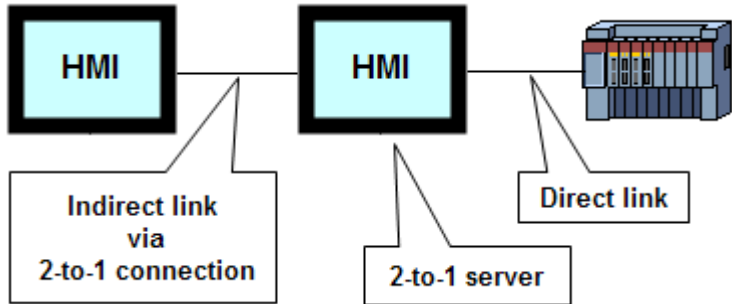
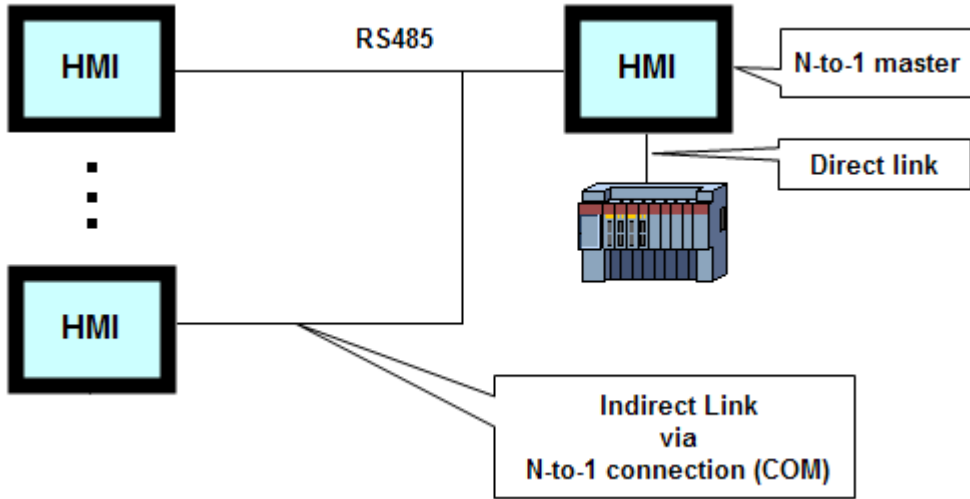
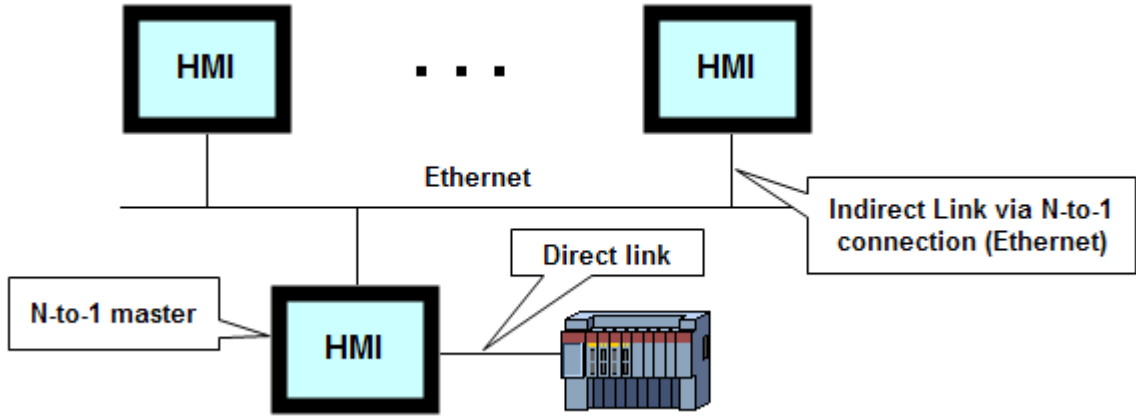
Link Type	Description
<p>Indirect link</p>	<p>Allow the panel to talk with a device that is not directly connected to it. An indirect link connects the panel with a specified indirect link server. The indirect link server is the target panel of a panel application in the same project and is directly connected to the specified device.</p> <p>[Example 1] Indirect Link via 2-to-1 Connection</p>  <p>[Example 2] Indirect Link via N-to-1 Connection (COM)</p>  <p>[Example 3] Indirect Link via N-to-1 Connection (Ethernet)</p> 

Continued

Link Type	Description										
Communication service	<p data-bbox="327 239 1485 331">Add an appropriate communication service link to the application to allow other panels to communicate with the device directly connected to the target panel. The following table describes the available communication services.</p> <table border="1" data-bbox="327 338 1465 1854"> <thead> <tr> <th data-bbox="331 344 667 409">Communication Service</th> <th data-bbox="667 344 1460 409">Description</th> </tr> </thead> <tbody> <tr> <td data-bbox="331 409 667 546">2-to-1 Server (COM)</td> <td data-bbox="667 409 1460 546">You need to specify the data link, i.e. the associated direct link, for this communication service. This service allows two panels to talk with one device, and only one communication port is required on that device.</td> </tr> <tr> <td data-bbox="331 546 667 1585">2-to-1 Transparent Server (COM)</td> <td data-bbox="667 546 1460 1585"> <p data-bbox="683 553 1449 703">This communication service makes the target panel a gateway for another computing device, such as, a PC, another target panel, or a panel of another brand, to access the associated controller. See the following diagrams for the possible applications.</p> <div data-bbox="692 719 1422 1346"> <p data-bbox="724 857 820 887">PM HMI</p> <p data-bbox="911 857 1225 887">2-to-1 Transparent Server</p> <p data-bbox="746 1088 799 1117">HMI</p> <p data-bbox="911 1088 1225 1117">2-to-1 Transparent Server</p> <p data-bbox="756 1312 799 1341">PC</p> <p data-bbox="911 1312 1225 1341">2-to-1 Transparent Server</p> </div> <p data-bbox="683 1361 1449 1579">Any kind of controller whose communication protocol is of the request-reply type can be supported by this communication service. Ask your local representative to check if your controller is supported. Note that the communication parameters (baud rate, number of data bits, number of stop bits, and type of parity check) of the computing device and the communication parameters of the 2-to-1 Transparent Server must be identical.</p> </td> </tr> <tr> <td data-bbox="331 1585 667 1722">N-to-1 Master (COM)</td> <td data-bbox="667 1585 1460 1722">You need to specify the data link, i.e. the associated direct link, for this communication service. This service allows up to 16 panels to talk with one device, and only one communication port is required on that device.</td> </tr> <tr> <td data-bbox="331 1722 667 1854">N-to-1 Master (Ethernet)</td> <td data-bbox="667 1722 1460 1854">You need to specify the data link, i.e. the associated direct link, for this communication service. This service allows up to 16 panels to talk with one device, and only one communication port is required on that device.</td> </tr> </tbody> </table>	Communication Service	Description	2-to-1 Server (COM)	You need to specify the data link, i.e. the associated direct link, for this communication service. This service allows two panels to talk with one device, and only one communication port is required on that device.	2-to-1 Transparent Server (COM)	<p data-bbox="683 553 1449 703">This communication service makes the target panel a gateway for another computing device, such as, a PC, another target panel, or a panel of another brand, to access the associated controller. See the following diagrams for the possible applications.</p> <div data-bbox="692 719 1422 1346"> <p data-bbox="724 857 820 887">PM HMI</p> <p data-bbox="911 857 1225 887">2-to-1 Transparent Server</p> <p data-bbox="746 1088 799 1117">HMI</p> <p data-bbox="911 1088 1225 1117">2-to-1 Transparent Server</p> <p data-bbox="756 1312 799 1341">PC</p> <p data-bbox="911 1312 1225 1341">2-to-1 Transparent Server</p> </div> <p data-bbox="683 1361 1449 1579">Any kind of controller whose communication protocol is of the request-reply type can be supported by this communication service. Ask your local representative to check if your controller is supported. Note that the communication parameters (baud rate, number of data bits, number of stop bits, and type of parity check) of the computing device and the communication parameters of the 2-to-1 Transparent Server must be identical.</p>	N-to-1 Master (COM)	You need to specify the data link, i.e. the associated direct link, for this communication service. This service allows up to 16 panels to talk with one device, and only one communication port is required on that device.	N-to-1 Master (Ethernet)	You need to specify the data link, i.e. the associated direct link, for this communication service. This service allows up to 16 panels to talk with one device, and only one communication port is required on that device.
Communication Service	Description										
2-to-1 Server (COM)	You need to specify the data link, i.e. the associated direct link, for this communication service. This service allows two panels to talk with one device, and only one communication port is required on that device.										
2-to-1 Transparent Server (COM)	<p data-bbox="683 553 1449 703">This communication service makes the target panel a gateway for another computing device, such as, a PC, another target panel, or a panel of another brand, to access the associated controller. See the following diagrams for the possible applications.</p> <div data-bbox="692 719 1422 1346"> <p data-bbox="724 857 820 887">PM HMI</p> <p data-bbox="911 857 1225 887">2-to-1 Transparent Server</p> <p data-bbox="746 1088 799 1117">HMI</p> <p data-bbox="911 1088 1225 1117">2-to-1 Transparent Server</p> <p data-bbox="756 1312 799 1341">PC</p> <p data-bbox="911 1312 1225 1341">2-to-1 Transparent Server</p> </div> <p data-bbox="683 1361 1449 1579">Any kind of controller whose communication protocol is of the request-reply type can be supported by this communication service. Ask your local representative to check if your controller is supported. Note that the communication parameters (baud rate, number of data bits, number of stop bits, and type of parity check) of the computing device and the communication parameters of the 2-to-1 Transparent Server must be identical.</p>										
N-to-1 Master (COM)	You need to specify the data link, i.e. the associated direct link, for this communication service. This service allows up to 16 panels to talk with one device, and only one communication port is required on that device.										
N-to-1 Master (Ethernet)	You need to specify the data link, i.e. the associated direct link, for this communication service. This service allows up to 16 panels to talk with one device, and only one communication port is required on that device.										

Continued

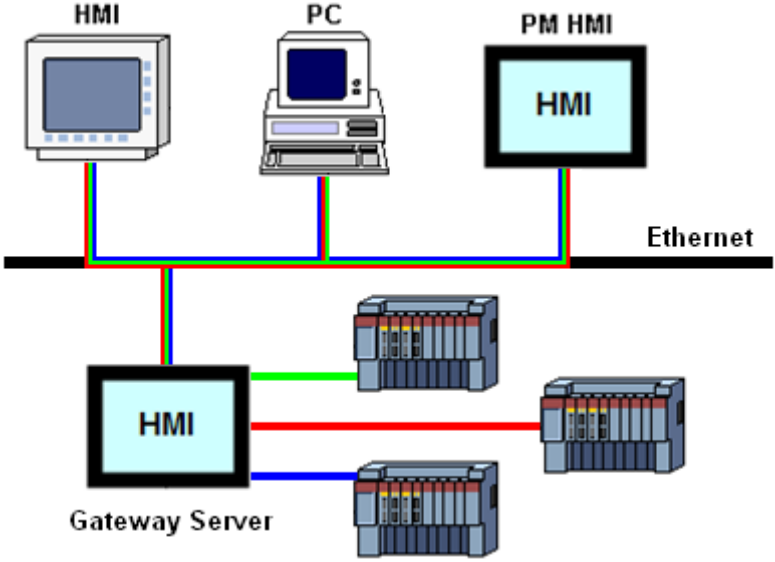
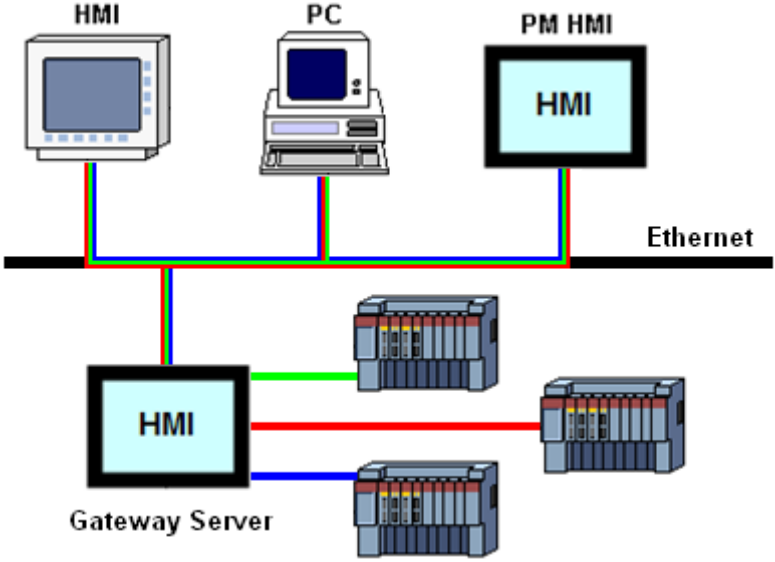
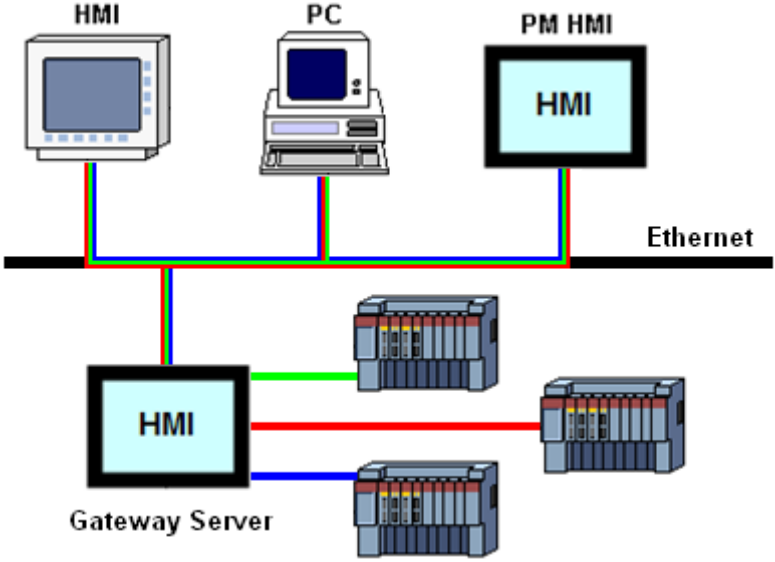
Link Type	Description				
<p>Gateway service</p>	<p>Allows an application program running on any computing device, such as a PC, to access the data of the controllers that are connected to the HMI with Gateway Server. The following table describes the available gateway services.</p> <table border="1" data-bbox="328 353 1484 1361"> <thead> <tr> <th data-bbox="328 353 624 392">Gateway Service</th> <th data-bbox="624 353 1484 392">Description</th> </tr> </thead> <tbody> <tr> <td data-bbox="328 392 624 1361"> <p>TCP/IP Gateway Server (Ethernet)</p> </td> <td data-bbox="624 392 1484 1361"> <p>This gateway service makes the target panel a gateway for another computing device, such as, a PC, another target panel, or a panel of other brand, to access the associated controller through Ethernet. See the following diagram to know the possible applications.</p>  <p>The blue, green, and red lines in the above figure indicate the different data blocks flowing on the Ethernet with the target panel acting as a gateway server.</p> <p>The gateway server makes the HMI behave as a Modbus device. Your application program can use the Modbus protocol to access the transfer memory of the gateway server. To use the gateway server, please see Section 3.4.8 for details.</p> </td> </tr> </tbody> </table>	Gateway Service	Description	<p>TCP/IP Gateway Server (Ethernet)</p>	<p>This gateway service makes the target panel a gateway for another computing device, such as, a PC, another target panel, or a panel of other brand, to access the associated controller through Ethernet. See the following diagram to know the possible applications.</p>  <p>The blue, green, and red lines in the above figure indicate the different data blocks flowing on the Ethernet with the target panel acting as a gateway server.</p> <p>The gateway server makes the HMI behave as a Modbus device. Your application program can use the Modbus protocol to access the transfer memory of the gateway server. To use the gateway server, please see Section 3.4.8 for details.</p>
Gateway Service	Description				
<p>TCP/IP Gateway Server (Ethernet)</p>	<p>This gateway service makes the target panel a gateway for another computing device, such as, a PC, another target panel, or a panel of other brand, to access the associated controller through Ethernet. See the following diagram to know the possible applications.</p>  <p>The blue, green, and red lines in the above figure indicate the different data blocks flowing on the Ethernet with the target panel acting as a gateway server.</p> <p>The gateway server makes the HMI behave as a Modbus device. Your application program can use the Modbus protocol to access the transfer memory of the gateway server. To use the gateway server, please see Section 3.4.8 for details.</p>				

3.4.2. General Settings

This section describes how to define the general settings for the communication links using the General page of the Link Properties dialog box. The following is an example of the General page that defines a direct link.

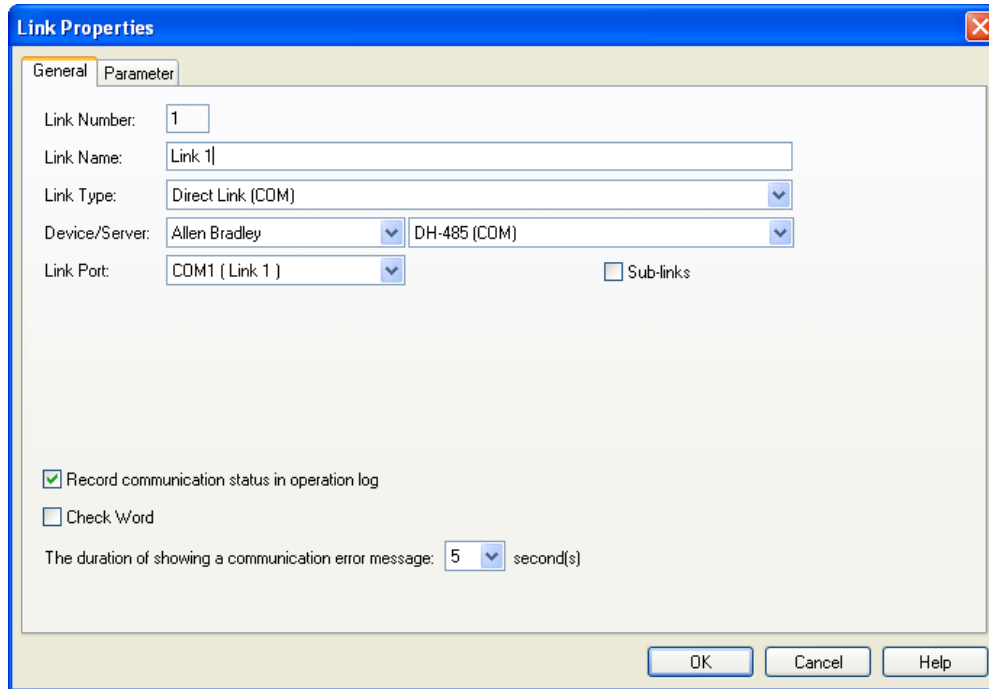

The screenshot shows the 'Link Properties' dialog box with the 'General' tab selected. The settings are as follows:

- Link Number: 1
- Link Name: Link 1
- Link Type: Direct Link (COM)
- Device/Server: Allen Bradley (dropdown), DH-485 (COM) (dropdown)
- Link Port: COM1 (Link 1) (dropdown)
- Sub-links
- Record communication status in operation log
- Check Word
- The duration of showing a communication error message: 5 (dropdown) second(s)

Buttons at the bottom: OK, Cancel, Help.

The following is an example of the General page that defines a communication service link.

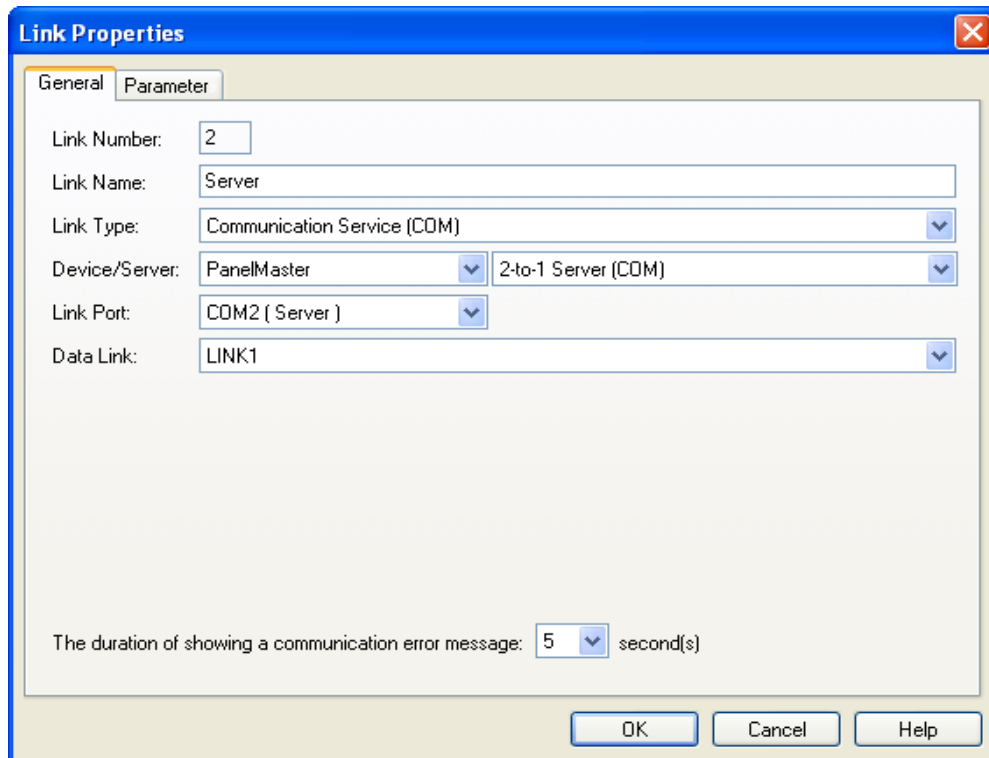

The screenshot shows the 'Link Properties' dialog box with the 'General' tab selected. The settings are as follows:

- Link Number: 2
- Link Name: Server
- Link Type: Communication Service (COM)
- Device/Server: PanelMaster (dropdown), 2-to-1 Server (COM) (dropdown)
- Link Port: COM2 (Server) (dropdown)
- Data Link: LINK1 (dropdown)
- The duration of showing a communication error message: 5 (dropdown) second(s)

Buttons at the bottom: OK, Cancel, Help.

The following table describes each property in the General page of the Link Properties dialog box.

Property	Description																		
Link Number	The sequence number of the communication link. It is assigned when the link is created and reassigned when any other link of the same application is removed.																		
Link Name	Specifies the name of the communication link.																		
Link Type	Select one of the following link types for the link: <table border="1" data-bbox="395 432 1485 1523"> <thead> <tr> <th>Link Type</th> <th>Description</th> </tr> </thead> <tbody> <tr> <td>Direct Link (COM)</td> <td>The link connects to the specified device directly through the specified serial (COM) port.</td> </tr> <tr> <td>Direct Link (Ethernet)</td> <td>The link connects to the specified device directly through the specified Ethernet port.</td> </tr> <tr> <td>Communication Service (COM)</td> <td>The link connects to one or more other target panels through the specified serial (COM) port and provides the communication service specified in the Device/Server field to the connected target panels. See the description of the Device/Server field to know the available communication services.</td> </tr> <tr> <td>Communication Service (Ethernet)</td> <td>The link connects to one or more other target panels through the specified Ethernet port and provides the communication service specified in the Device/Server field to the connected target panels. See the description of the Device/Server field to know the available communication services.</td> </tr> <tr> <td>Gateway Service(Ethernet)</td> <td>The link connects to a target panel that provides gateway service as a gateway server through the specified Ethernet port. The target panel allows an application program running on any computing device, such as a PC, to access the data of the controllers through that target panel.</td> </tr> <tr> <td>Indirect Link via 2-to-1 Connection (COM)</td> <td>The link connects to a target panel that provides the communication service as a 2-to1 server through the specified serial (COM) port. The target panel can communicate with the associated device indirectly through that target panel.</td> </tr> <tr> <td>Indirect Link via N-to-1 Connection (COM)</td> <td>The link connects to a target panel that provides the communication service as an N-to1 master through the specified serial (COM) port. The target panel can communicate with the associated device indirectly through that target panel.</td> </tr> <tr> <td>Indirect Link via N-to-1 Connection (Ethernet)</td> <td>The link connects to a target panel that provides the communication service as an N-to1 master through the specified Ethernet port. The target panel can communicate with the associated device indirectly through that target panel.</td> </tr> </tbody> </table>	Link Type	Description	Direct Link (COM)	The link connects to the specified device directly through the specified serial (COM) port.	Direct Link (Ethernet)	The link connects to the specified device directly through the specified Ethernet port.	Communication Service (COM)	The link connects to one or more other target panels through the specified serial (COM) port and provides the communication service specified in the Device/Server field to the connected target panels. See the description of the Device/Server field to know the available communication services.	Communication Service (Ethernet)	The link connects to one or more other target panels through the specified Ethernet port and provides the communication service specified in the Device/Server field to the connected target panels. See the description of the Device/Server field to know the available communication services.	Gateway Service(Ethernet)	The link connects to a target panel that provides gateway service as a gateway server through the specified Ethernet port. The target panel allows an application program running on any computing device, such as a PC, to access the data of the controllers through that target panel.	Indirect Link via 2-to-1 Connection (COM)	The link connects to a target panel that provides the communication service as a 2-to1 server through the specified serial (COM) port. The target panel can communicate with the associated device indirectly through that target panel.	Indirect Link via N-to-1 Connection (COM)	The link connects to a target panel that provides the communication service as an N-to1 master through the specified serial (COM) port. The target panel can communicate with the associated device indirectly through that target panel.	Indirect Link via N-to-1 Connection (Ethernet)	The link connects to a target panel that provides the communication service as an N-to1 master through the specified Ethernet port. The target panel can communicate with the associated device indirectly through that target panel.
Link Type	Description																		
Direct Link (COM)	The link connects to the specified device directly through the specified serial (COM) port.																		
Direct Link (Ethernet)	The link connects to the specified device directly through the specified Ethernet port.																		
Communication Service (COM)	The link connects to one or more other target panels through the specified serial (COM) port and provides the communication service specified in the Device/Server field to the connected target panels. See the description of the Device/Server field to know the available communication services.																		
Communication Service (Ethernet)	The link connects to one or more other target panels through the specified Ethernet port and provides the communication service specified in the Device/Server field to the connected target panels. See the description of the Device/Server field to know the available communication services.																		
Gateway Service(Ethernet)	The link connects to a target panel that provides gateway service as a gateway server through the specified Ethernet port. The target panel allows an application program running on any computing device, such as a PC, to access the data of the controllers through that target panel.																		
Indirect Link via 2-to-1 Connection (COM)	The link connects to a target panel that provides the communication service as a 2-to1 server through the specified serial (COM) port. The target panel can communicate with the associated device indirectly through that target panel.																		
Indirect Link via N-to-1 Connection (COM)	The link connects to a target panel that provides the communication service as an N-to1 master through the specified serial (COM) port. The target panel can communicate with the associated device indirectly through that target panel.																		
Indirect Link via N-to-1 Connection (Ethernet)	The link connects to a target panel that provides the communication service as an N-to1 master through the specified Ethernet port. The target panel can communicate with the associated device indirectly through that target panel.																		

Continued

Property	Description												
Device/Server	<p>When the Link Type is Direct Link, specify the link's connected device.</p> <p>When the Link Type is Communication Service (COM), select one of the following servers.</p> <table border="1"> <thead> <tr> <th>Server</th> <th>Description</th> </tr> </thead> <tbody> <tr> <td>2-to-1 Server</td> <td>In the Data Link field, specify a direct link of the application as the data link for the server. The 2-to-1 server is a bridge between another panel and the device connected to the specified data link. Another panel/application of the project can now use an indirect link to access the device connected to the server through the specified data link.</td> </tr> <tr> <td>2-to-1 Transparent Server</td> <td>In the Data Link field, specify a direct link of the application as the data link for the server. The service link connects to a computing device, and allows the device to indirectly communicate with another device through the data link. The computing device can be a target panel, a panel of another brand, or a PC. If the computing device is a target panel, it must use a direct link to accept the service.</td> </tr> <tr> <td>N-to-1 Master</td> <td>In the Data Link field, specify a direct link of the application as the data link for the server. The link can connect up to 8 target panels, and allow these panels to indirectly communicate with the device connected to the specified data link. The panels served by the link must use an indirect link to accept the service.</td> </tr> </tbody> </table> <p>When the Link Type is Communication Service (Ethernet), select one of the following servers.</p> <table border="1"> <thead> <tr> <th>Server</th> <th>Description</th> </tr> </thead> <tbody> <tr> <td>N-to-1 Master</td> <td>In the Data Link field, specify a direct link of the application as the data link for the server. The link can connect up to 8 target panels, and allow these panels to indirectly communicate with the device connected to the specified data link. The panels served by the link must use an indirect link to accept the service.</td> </tr> </tbody> </table> <p>When the Link Type is Indirect Link and the Indirect Link Server Location is specified, the indirectly connected device is shown here.</p>	Server	Description	2-to-1 Server	In the Data Link field, specify a direct link of the application as the data link for the server. The 2-to-1 server is a bridge between another panel and the device connected to the specified data link. Another panel/application of the project can now use an indirect link to access the device connected to the server through the specified data link.	2-to-1 Transparent Server	In the Data Link field, specify a direct link of the application as the data link for the server. The service link connects to a computing device, and allows the device to indirectly communicate with another device through the data link. The computing device can be a target panel, a panel of another brand, or a PC. If the computing device is a target panel, it must use a direct link to accept the service.	N-to-1 Master	In the Data Link field, specify a direct link of the application as the data link for the server. The link can connect up to 8 target panels, and allow these panels to indirectly communicate with the device connected to the specified data link. The panels served by the link must use an indirect link to accept the service.	Server	Description	N-to-1 Master	In the Data Link field, specify a direct link of the application as the data link for the server. The link can connect up to 8 target panels, and allow these panels to indirectly communicate with the device connected to the specified data link. The panels served by the link must use an indirect link to accept the service.
Server	Description												
2-to-1 Server	In the Data Link field, specify a direct link of the application as the data link for the server. The 2-to-1 server is a bridge between another panel and the device connected to the specified data link. Another panel/application of the project can now use an indirect link to access the device connected to the server through the specified data link.												
2-to-1 Transparent Server	In the Data Link field, specify a direct link of the application as the data link for the server. The service link connects to a computing device, and allows the device to indirectly communicate with another device through the data link. The computing device can be a target panel, a panel of another brand, or a PC. If the computing device is a target panel, it must use a direct link to accept the service.												
N-to-1 Master	In the Data Link field, specify a direct link of the application as the data link for the server. The link can connect up to 8 target panels, and allow these panels to indirectly communicate with the device connected to the specified data link. The panels served by the link must use an indirect link to accept the service.												
Server	Description												
N-to-1 Master	In the Data Link field, specify a direct link of the application as the data link for the server. The link can connect up to 8 target panels, and allow these panels to indirectly communicate with the device connected to the specified data link. The panels served by the link must use an indirect link to accept the service.												
Link Port	Select a port for this link.												
Sub-links	<p>When an RS485 communication line has many devices connected to it, the logical connection of a device on the link with the target panel is called a sub-link.</p> <p>This field is available when the Link Type is Direct Link (COM). Select this option if this link will connect to many devices, and you want to identify, monitor, or control the communication with each connected device.</p>												
Data Link	Select a direct link of the application as the data link for the communication service when the Link Type is Communication Service.												
Indirect Link Server Location	Panel Application	Select the panel application that provides the communication service for this indirect link.											
	Link	Select the communication service link that provides the communication service for this indirect link.											
Record communication status in operation log	Check this option if you want the communication status of the link or the link's sub-links to be recorded in the operation log. The recordable types of status include: Enabled, Disabled, Failed, and Recovered. The operation log display can show the logged communication status.												
Check Word	The panel will read the specified word periodically to check the status of the link's connection.												
The duration of showing a communication error message	The communication error message box will hide and show according to the specified duration. If the duration is 0, the error message box will not show.												

3.4.3. Parameter Settings (Serial Port)

This section describes how to set up the communication parameters for the serial communication links using the Parameter page of the Link Properties dialog box.

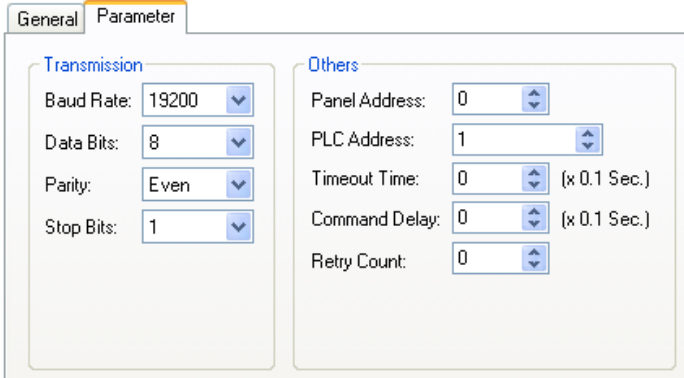
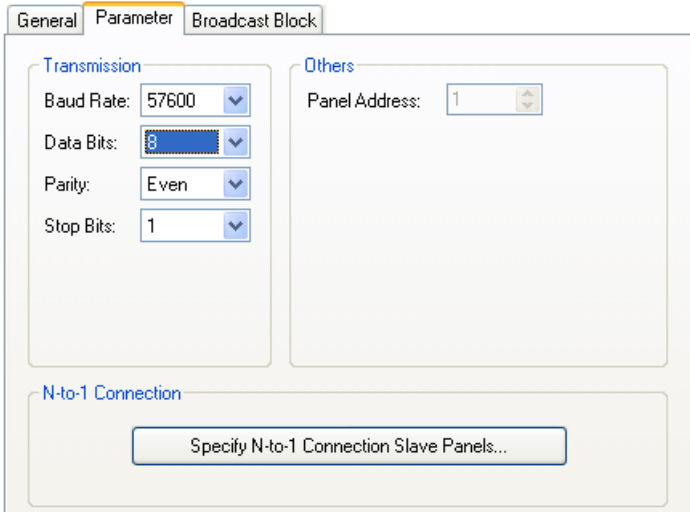
<p>The following is an example of the Parameter page for a serial direct link.</p>	<p>The following is an example of the Parameter page for an N-to-1 master.</p>
	

The following table describes each property in the Parameter page of the Link Properties dialog box for a serial link.

Property	Description
Baud Rate	The baud rate used.
Data Bits	The number of data bits used.
Parity	The scheme of parity used.
Stop Bits	The number of stop bits used.
Panel Address	The address of the target panel.
PLC Address	The address of the connected device.
Timeout Time	The maximum time allowed for the communication driver to wait for a reply from the connected device. When the elapsed time exceeds the Timeout Time, the communication driver assumes the communication failed.
Command Delay	If the Command Delay is 0, the communication driver immediately sends the next request to the connected device when it receives a reply from the last request. If the Command Delay is nonzero, the communication driver delays for the specified amount of time before sending the next request to the connected device.
Retry Count	The number of times the communication driver will retry for each request to get a successful reply from the connected device. If the number is zero, the communication driver will use the default retry count.
Specify N-to-1 Connection Slave Panels	This button is available when the link is an N-to-1 master. Click this button to bring up the N-to-1 Connection Slave Panels dialog box. You can define the slave panels of the N-to-1 connection in the dialog box.
Specify Other Data Sharing Panels	This button is available when the link is a direct link and the connected device is Data Sharer (RS485). Click this button to bring up the Other Data Sharing Panels dialog box. You can define the other data sharing panels in the dialog box.

3.4.4. Parameter Settings (Ethernet Port)

This section describes how to set up the communication parameters for Ethernet links using the Parameter page of the Link Properties dialog box. The following is an example of the Parameter page for an Ethernet direct link.

The following table describes each property in the Parameter page of the Link Properties dialog box for an Ethernet link.

Property	Description
IP Address	The IP address of the connected device.
Use Default Port	Check this option if the default IP port is used
Port	Specifies the IP port used
Node Address	Specifies the node address of the connected device.
Timeout Time	The maximum time allowed for the communication driver to wait for a reply from the connected device. When the elapsed time exceeds the Timeout Time, the communication driver assumes the communication failed.
Command Delay	If the Command Delay is 0, the communication driver immediately sends the next request to the connected device when it receives a reply from the last request. If the Command Delay is nonzero, the communication driver delays for the specified amount of time before sending the next request to the connected device.
Retry Count	The number of times the communication driver will retry for each request to get a successful reply from the connected device. If the number is zero, the communication driver will use the default retry count.

3.4.5. Sub-link Settings

An RS485 link can have many slave devices connected to it. The HMI uses the same communication protocol to talk with all the slave devices. The connection between the HMI and each of the slave devices is a sub-link. With the Sub-link table, the operator can enable or disable a sub-link at any time.

This section describes how to define the sub-links within a direct link using the Sub-link page of the Link Properties dialog box. The following is an example of the Sub-link page.

Number of sub-links: 6

	Name	Node	State	Show
1	TC1	10	On	Yes
2	TC2	20	On	Yes
3	TC3	30	On	Yes
4	TC4	40	On	Yes
5	TC5	50	Off	Yes
6	TC6	60	Off	Yes

Language: English

Sub-link

Name: TC6

Node Address: 60

Initial State: Off

Show error message

Alt+Up: Move item up Alt+Down: Move item down

The following table describes each property in the Sub-link page of the Link Properties dialog box for a direct link.

Property	Description
Number of sub-links	Specifies how many devices the link will connect as sub-links.
Language	Specifies the current language for the Name field.
Name	The name of the selected sub-link for the language specified in the Language field.
Node Address	The address of the selected sub-link. The address must be a unique number within all the sub-links.
Initial State	The initial communication state for the selected sub-link. If the state is On, the panel will communicate with the sub-link after running the application. If the state is Off, the panel will not communicate with the sub-link until the communication state is turn On in a sub-link table.
Show error message	If this option is checked, the communication error message will be shown when the selected sub-link encounters communication errors. If this option is unchecked, no error message will be shown for any communication errors.

3.4.6. Sharing Data among Panels Using Data Sharer

The data sharer is a virtual device. It allows data sharing among up to 16 target panels on an Ethernet or an RS485 network. Each of the target panels can have up to 256 words of data to share.

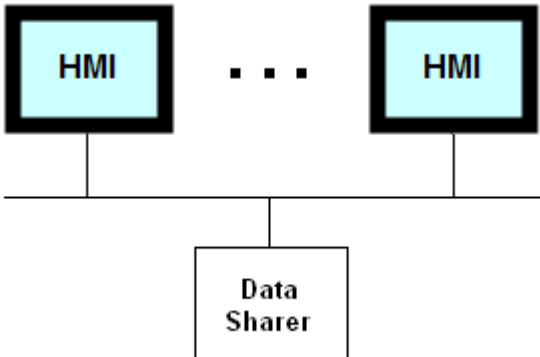

To set up the communication for data sharing, create a direct link and select Data Sharer (UDP) or Data Sharer (RS485) as the connected device. The panel address that you can set in the Parameter page of the Link Properties dialog box must be unique for each sharing panel as it is used to identify the shared data.

The communication driver for the link connecting to Data Sharer is responsible for broadcasting the panel's shared data on the network. For example, if the panel address of a panel is 10 and the number of the link connecting to Data Sharer is 2, the following Macro command will cause the communication driver to broadcast the corresponding data on the network.

```
2\P10.0 = MOV($u300, 30)
```

The communication driver receives the broadcasted shared data on the network automatically. It has a block of memory to store the shared data. To access a word, use the following address, where m is the panel address and n is the word number of that panel's shared data.

$Pm.n$ $m=1\sim 16; n=0\sim 255$

To access a bit, use the following address, where b is a hexadecimal number representing the bit number in the specified word.

$Pm.n.b$ $m=1\sim 16; n=0\sim 255; b=0\sim f$

The UDP is used for the data sharing on Ethernet.

3.4.7. Writing Communication Programs Using Macro Commands

You can write a macro program to let your HMI communicate with a computing device through a serial port. For simplicity, we will use Device in the following sections to refer to the target computing device.

1. Create a communication link for the application to connect the panel and Device.

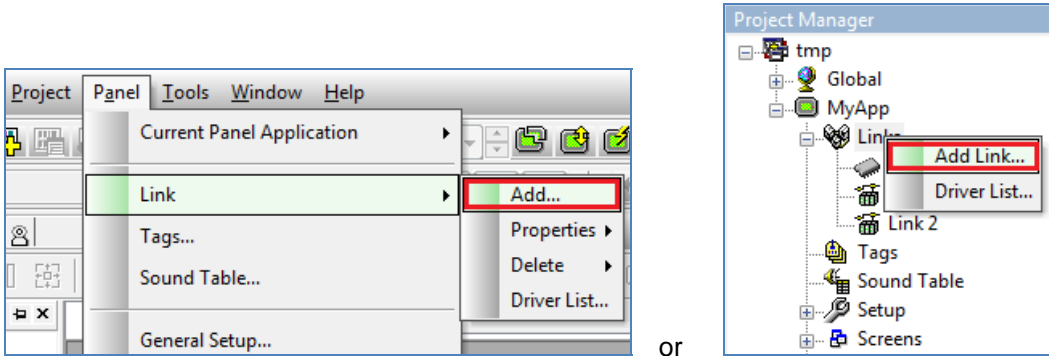

2. Specify the general settings for the link. You need to select PanelMaster - General Device (COM) as the device to be connected.

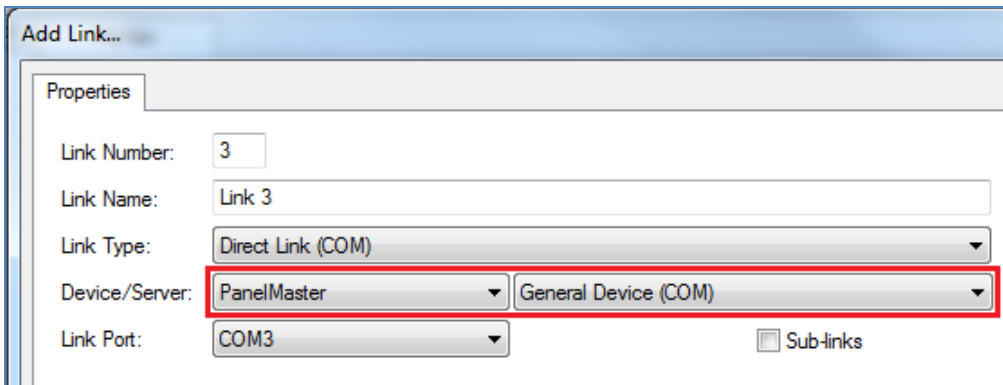

3. Specify the parameters of the communication.

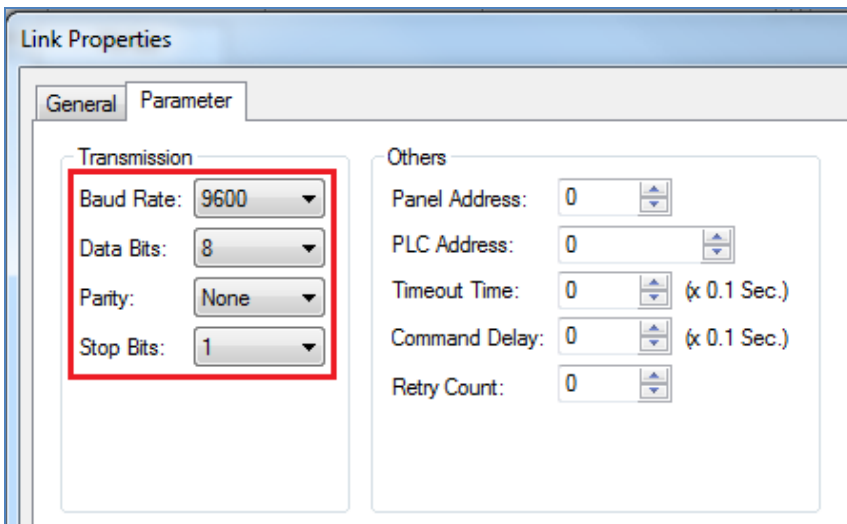

4. Understand the key words that are available for composing the communication macro programs.

Key Word	Type	R/W	Function								
TX	Word	Write Only	<p>Writing a block of words to TX transmits the low bytes of that block of words to Device. The write operation is done when the transmission starts or is cancelled.</p> <p><i>Example:</i></p> <pre>\$U10 = "ABC" \$U20 = B2W(\$U10, 3) // Convert the byte array to a word array TX = MOV(\$U20, 3) // Transmit "ABC" to Device</pre> <p><i>Operation rules:</i></p> <ol style="list-style-type: none"> 1) The transmission cannot start until the previous transmission has finished. 2) The word TXT_STS will be set to 1 when the transmission starts. 3) When the hardware flow control is enabled (Bit EN_HS is set to 1), the transmission will not start until the device allows the panel to send data (The CTS signal on the port is asserted). 4) When the RTS/CTS flow control is enabled (Bit EN_HS is set to 1), the RTS signal on the serial port will be negated when the transmission starts and it will be asserted when the transmission ends. 5) The transmission will be cancelled if it cannot start after waiting a time specified by the word TO_TIME. The word TX_STS will be set to 2 when the timeout condition occurs. 								
TX_W	Word	Write Only	TX_W provides the same functionality as TX, except that the write operation is done after all the bytes are transmitted. It is recommended to use TX_W to transmit data as the macro program will not waste time to wait for the completion and the CPU of the panel will be utilized more efficiently.								
TX_STS	Word	Read Only	<p>Reading this word gets the status of the last transmission.</p> <table border="1"> <thead> <tr> <th>Value</th> <th>Status</th> </tr> </thead> <tbody> <tr> <td>1</td> <td>Succeeded</td> </tr> <tr> <td>2</td> <td>Timeout</td> </tr> <tr> <td>255</td> <td>In progress</td> </tr> </tbody> </table>	Value	Status	1	Succeeded	2	Timeout	255	In progress
Value	Status										
1	Succeeded										
2	Timeout										
255	In progress										
RX	Word	Read Only	<p>Reading this word copies a specified number of word values from the receive buffer. The receive buffer is a word array. The bytes received from Device are stored in the low bytes of the buffer. The high bytes of the buffer are always 0. Once the received data are copied, they are removed from the receive buffer. The read operation is executed whether or not there are enough bytes received in the buffer.</p> <p><i>Example:</i></p> <pre>\$U10 = MOV(RX, 3) // Receive 3 words from the receive buffer. // \$U10 gets the value of the first received byte. // \$U11 gets the value of the second received byte. // \$U12 gets the value of the third received byte.</pre> <p><i>Operation rules:</i></p> <p>Assume the number of words to be read from the buffer is n and the number of available words in the buffer is m.</p> <ol style="list-style-type: none"> 1) If there are enough data received in the buffer, the read operation does the following 4 things: copies the first n words in the buffer to the destination, sets RX_CNT to n, sets RXB_CNT to (m-n), and sets RX_STS to 1. 2) If there are not enough data received in the buffer, the read operation does the following 4 things: copies all the available data to the destination, sets RX_CNT to m, sets RXB_CNT to 0, and sets RX_STS to 1. 								

Continued

Key Word	Type	R/W	Function								
RXB_CNT	Word	Read Only	Reading this word gets the number of words that are available in the receive buffer. Note that one word of the receive buffer contains one received byte.								
RX_CNT	Word	Read Only	Reading this word gets the number of words that were actually taken out of the receive buffer by the last receive operation. Note that one word of the receive buffer contains one received byte.								
RX_STS	Word	Read Only	Reading this word gets the status of the last receive operation. <table border="1" style="width: 100%; border-collapse: collapse;"> <thead> <tr> <th>Word Value</th> <th>Description</th> </tr> </thead> <tbody> <tr> <td>1</td> <td>Succeeded</td> </tr> <tr> <td>2</td> <td>Timeout</td> </tr> <tr> <td>Others</td> <td>Failed</td> </tr> </tbody> </table>	Word Value	Description	1	Succeeded	2	Timeout	Others	Failed
Word Value	Description										
1	Succeeded										
2	Timeout										
Others	Failed										
RX_W	Word	Read Only	<p>Reading this word copies a specified number of word values from the receive buffer. The receive buffer is a word array. The bytes received from Device are stored in the low bytes of the buffer. The high bytes of the buffer are always 0. Once the received data are copied, they are removed from the receive buffer. If there are not enough data received in the buffer, the read operation will wait a time specified by TO_TIME. The read operation will not complete until all the required data are received or the timeout occurs.</p> <p><i>Example:</i></p> <pre style="color: green;">\$U10 = MOV(RX_W, 3) // Receive 3 words from the receive buffer. // Wait for the data if they are not received from Device yet. // \$U10 gets the value of the first received byte. // \$U11 gets the value of the second received byte. // \$U12 gets the value of the third received byte.</pre> <p><i>Operation rules:</i></p> <p>Assume the number of words to be read from the buffer is n and the number of available words in the buffer is m</p> <ol style="list-style-type: none"> 1) If there are enough data received in the buffer, the read operation does the following 4 things: copies the first n words in the buffer to the destination, sets RX_CNT to n, sets RXB_CNT to (m-n), and sets RX_STS to 1. 2) If there are not enough data received in the buffer, the read operation will wait a time specified by TO_TIME for the required data to come. When enough data are received, the read operation performs rule 1 above. When timeout occurs, the read operation is cancelled and RX_STS is set to 2. 								
FLUSH	Bit	Write Only	Writing 1 to this bit flushes the receive buffer that is used to receive data from Device.								
RESET	Bit	Write Only	Writing 1 to this bit resets the UART that is used for the communication between the panel and Device.								
TO_TIME	Word	Read/Write	<p>Writing the timeout time to this word sets the timeout time for the communication. The unit is 0.1 second.</p> <p><i>Example:</i></p> <pre style="color: green;">TO_TIME = 20 (U) // Set the timeout time to 2 second</pre>								
EN_HS	Bit	Read/Write	<p>Writing 1 to the bit enables the RTS/CTS flow control.</p> <table border="1" style="width: 100%; border-collapse: collapse;"> <thead> <tr> <th>Bit Value</th> <th>Function</th> </tr> </thead> <tbody> <tr> <td>0</td> <td>Disables the hardware flow control.</td> </tr> <tr> <td>1</td> <td>Enables the hardware flow control.</td> </tr> </tbody> </table> <p><i>Example:</i></p> <pre style="color: green;">EN_HS = 1 (B) // Enable the flow control</pre>	Bit Value	Function	0	Disables the hardware flow control.	1	Enables the hardware flow control.		
Bit Value	Function										
0	Disables the hardware flow control.										
1	Enables the hardware flow control.										

Continued

Key Word	Type	R/W	Function									
CTS_STS	Bit	Read Only	Reading the bit gets the status of the CTS signal from the device.									
			<table border="1"> <thead> <tr> <th>Bit Value</th> <th>CTS Signal</th> <th>Comment</th> </tr> </thead> <tbody> <tr> <td>0</td> <td>Asserted</td> <td>The panel is allowed to send data to Device</td> </tr> <tr> <td>1</td> <td>Negated</td> <td>The panel is not allowed to send data to Device</td> </tr> </tbody> </table>	Bit Value	CTS Signal	Comment	0	Asserted	The panel is allowed to send data to Device	1	Negated	The panel is not allowed to send data to Device
			Bit Value	CTS Signal	Comment							
0	Asserted	The panel is allowed to send data to Device										
1	Negated	The panel is not allowed to send data to Device										
<p><i>Example:</i></p> <pre>IF !CTS_STS (B) // Do the following when the CTS is asserted TX = MOV(\$U100, 10) // Send 10 bytes to Device ENDIF</pre>												
RTS	Bit	Read/Write	Writing 0 to the bit asserts the RTS signal on the port.									
			<table border="1"> <thead> <tr> <th>Bit Value</th> <th>Function</th> </tr> </thead> <tbody> <tr> <td>0</td> <td>Asserts the RTS signal. The Device is allowed to send data to the panel.</td> </tr> <tr> <td>1</td> <td>Negates the RTS signal. The Device is not allowed to send data to the panel.</td> </tr> </tbody> </table>	Bit Value	Function	0	Asserts the RTS signal. The Device is allowed to send data to the panel.	1	Negates the RTS signal. The Device is not allowed to send data to the panel.			
			Bit Value	Function								
0	Asserts the RTS signal. The Device is allowed to send data to the panel.											
1	Negates the RTS signal. The Device is not allowed to send data to the panel.											
<p><i>Example:</i></p> <pre>RTS = 1 (B) // Disallow Device to send data to the panel</pre>												

- Understand the communication protocol.
- Write the program. The following is an example:

The screenshot shows a macro editor window titled "Macro - General Device" with the following assembly code:

```

0  $U10 = "ABCDE"           // $U10 = 4241H, $U11 = 4443H, $U12 = 4500H
1  $U20 = B2W($U10, 5)     // $U20 = 0041H, $U21 = 0042H, $U22 = 0043H
2                             // $U23 = 0044H, $U24 = 0045H
3  TX_W = MOV($U20, 5)     // Send 5 words("ABCDE") in $U20 to TX
4                             // and wait until all datum are sent
5
6  $U25 = 0DH              // 0DH is ASCII code for return charater
7  TX_W = MOV($U20, 6)     // Send 6 words("ABCDE<CR>") in $U20 to TX
8                             // and wait until all datum are sent
9
10 TX = MOV($U20, 5)       // Send 5 words in $U20 to TX
11
12 $U100 = MOV(RX, 5)      // Read 5 words from RX to $U100
13 $U100 = MOV(RX_W, 5)   // Read 5 words from RX to $U100
14                             // and wait until all datum are received
15
16 RESET = 1 (B)          // Reset TX UART and clear RX buffer
17 FLUSH = 1 (B)          // Clear RX buffer
18
19

```

The Properties window on the right shows the configuration for the instruction `P1 = MOV(P2, P3)`. The Data Type is (U) 16-bit Unsigned. The parameters are:

- Par. P1: TX_W
- Par. P2: \$U20
- Par. P3: 5

The Operation section states: "Copies P3 words of P2 to P1." The Parameters table is as follows:

	Type	Description
P1	I/E	The starting location of the memory to receive the copy.
		The starting location

3.4.8. Using Gateway Server of the Target Panel

A gateway server in a HMI allows an application program running on any computing device, such as a PC, to access the data of the controllers that are connected to that HMI. The HMI behaves as a Modbus device. Your application program can use the Modbus protocol to access the transfer memory provided by the gateway server.

There are two gateway servers available to be selected for your application. The Serial Gateway Server is for the serial port connection, and the TCP/IP Gateway Server is for the Ethernet port connection.

Gateway Server	Protocol Used	Link Type
TCP/IP Gateway Server	Modbus TCP/IP	Ethernet
Serial Gateway Server	Modbus RTU	RS-232/422/485

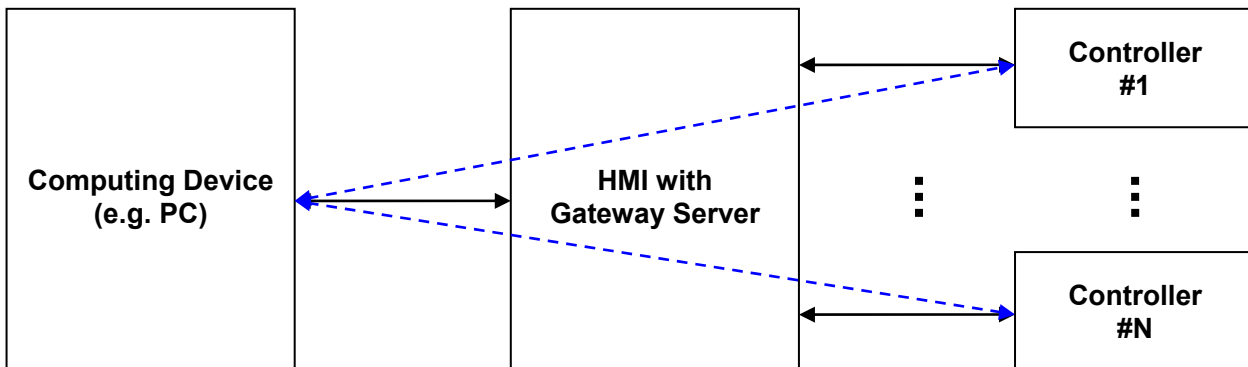

The blue dashed lines shown in the above figure indicate that the PC can access the data of Controller #1 and Controller #N through the HMI with the help of the gateway server.

3.4.8.1. Setting up Gateway Service

Suppose that the application has two links: One direct link that connects the target panel and PanelMaster->Null PLC device through COM1; the other direct link that connects the target panel and Siemens AG->Simatic S7-300(MPI Port) device through COM2. To use the gateway service, you may do the followings:

1. Create a new link and select Gateway Service (Ethernet) as the Link Type and PanelMaster->TCP/IP Gateway Server as the Device/Server in Link Properties dialog box.

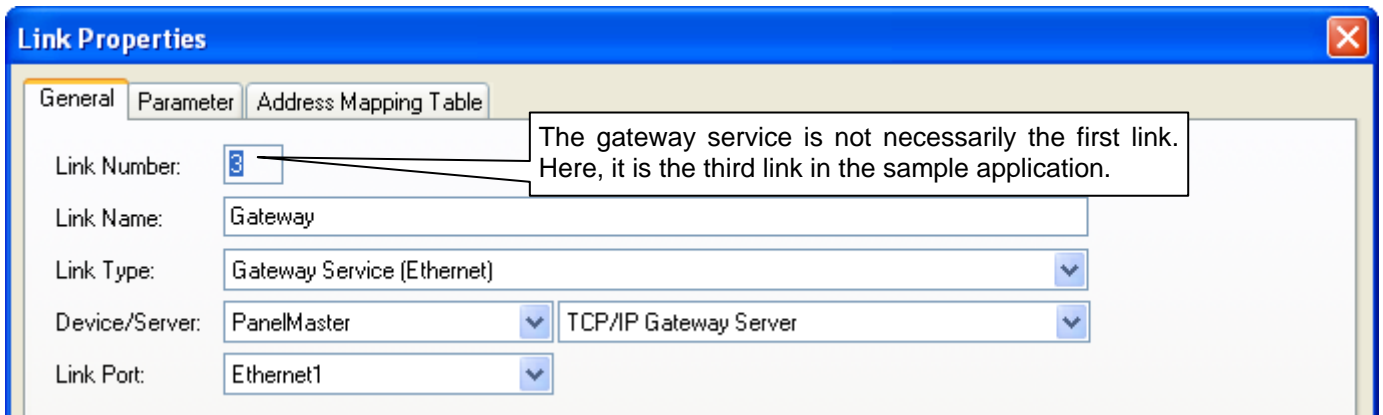

2. You need to define the address mapping table for the gateway server because:
 - When your application writes a block of data to the transfer memory of the gateway server, the gateway server knows the real destination of that block of data, and writes the data to the real destination for your application.
 - When your application program reads a location of the transfer memory of the gateway server, the gateway server knows the real data source of the read operation, and retrieves the data from the real data source for your application.

To define the address mapping table, click the Address Mapping Table tab in the Link Properties dialog. The following is an example of the Address Mapping Table page.

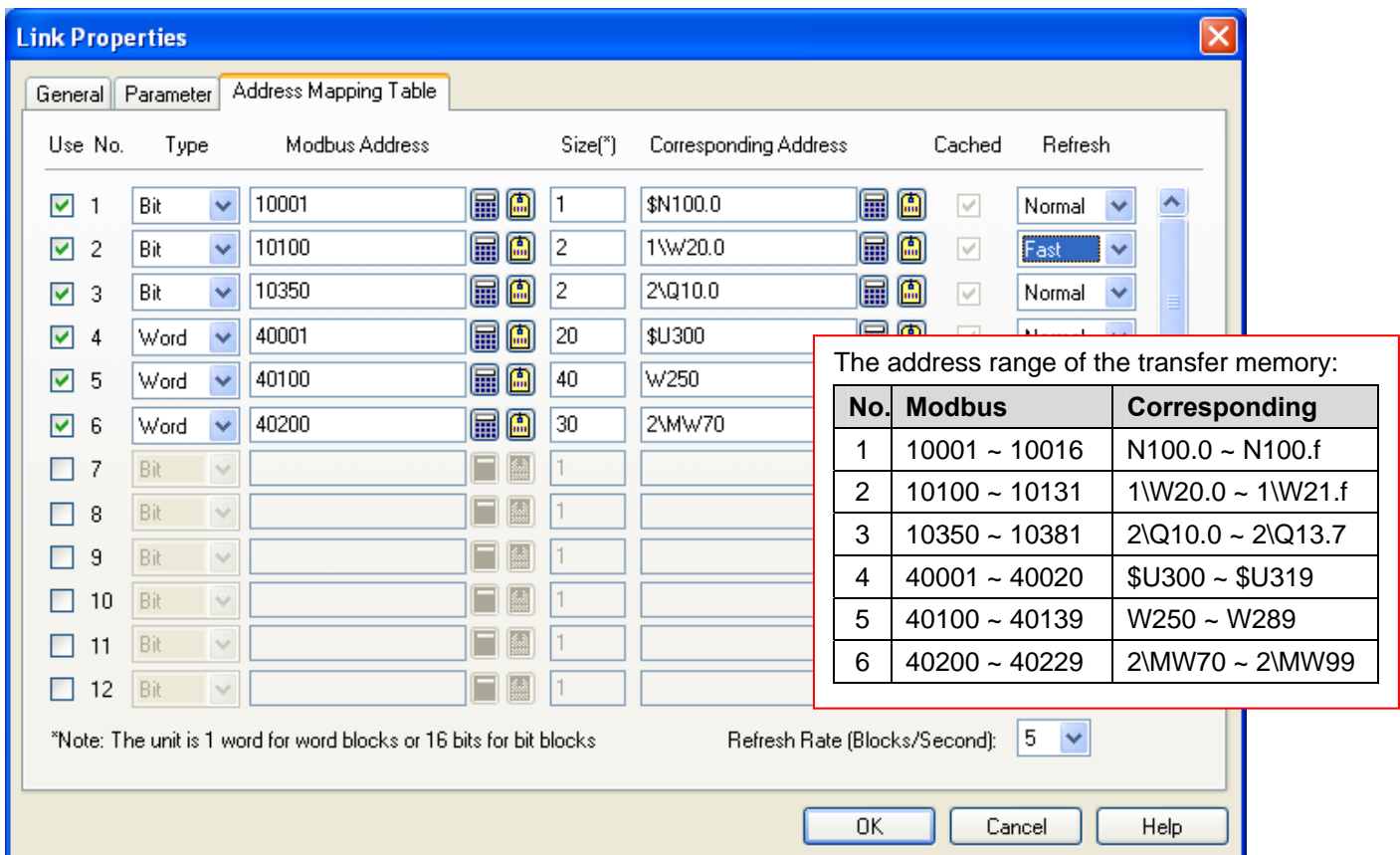

The following table describes each property in the Address Mapping Table page of the Link Properties dialog box for a Gateway Service (Ethernet) link.

Property	Description																				
Use	Check this option if you want to use mapping block #n.																				
No	The mapping block's number.																				
Type	Select location type for the mapping block. Bit indicates a bit block, and Word indicates a word block.																				
Modbus Address	The starting address in the computing device that is using the Modbus protocol. The address ranges and the location types of the transfer memory are shown in the table.																				
	<table border="1"> <thead> <tr> <th>Address Range</th> <th>Location Type</th> <th>Max. Size of Block Read/Write</th> <th>Note</th> </tr> </thead> <tbody> <tr> <td>1~9999</td> <td>Bit</td> <td>256 bits</td> <td>Read Only</td> </tr> <tr> <td>10001~19999</td> <td>Bit</td> <td>256 bits</td> <td></td> </tr> <tr> <td>30001~39999</td> <td>Word</td> <td>128 words</td> <td>Read Only</td> </tr> <tr> <td>40001~49999</td> <td>Word</td> <td>128 words</td> <td></td> </tr> </tbody> </table>	Address Range	Location Type	Max. Size of Block Read/Write	Note	1~9999	Bit	256 bits	Read Only	10001~19999	Bit	256 bits		30001~39999	Word	128 words	Read Only	40001~49999	Word	128 words	
	Address Range	Location Type	Max. Size of Block Read/Write	Note																	
	1~9999	Bit	256 bits	Read Only																	
	10001~19999	Bit	256 bits																		
30001~39999	Word	128 words	Read Only																		
40001~49999	Word	128 words																			
Size	The block size. If the location type is Word, the unit is 1 word. If the location type is Bit, the unit is 16 bits. For example: The size of the mapping bit block, 3, is 2 words and 32 bits.																				
Corresponding Address	The starting address of the corresponding controller or the target panel with gateway server.																				
Cached	Check this option to save data into the memory devoted to high-speed retrieval of requested data.																				
Refresh	Available only when the Cached option is checked. Select Fast to refresh data in the memory every second. Select Normal to refresh data in the memory every 3 seconds.																				

Limitations:

1. At most, 32 mapping blocks can be defined.
2. At most, 12 mapping blocks can be cached.
3. At most, 4 of the cached mapping blocks can have fast refresh rate.
4. When reading a block of words or bits, the words or bits must be within a single mapping block, or the read operation will fail.



3.5. Sound Table

The sound table contains all the sounds used by the panel application. The sound table is empty when the panel application is initially created.

In the application, you can use the function button with the play sound operation to play a specified sound.

Before using the sound in a panel application, import or add a sound into the Sound Table.

To open the Sound Table dialog box, please do one of the following:

- 1) In the Project Manager window, double-click the Sound Table () node of the panel application.
- 2) In the Project Manager window, right-click the Sound Table () node to bring out the pop-up menu and select Properties.
- 3) On the Panel menu, click Sound Table...

The following is an example of the Sound Table dialog box.

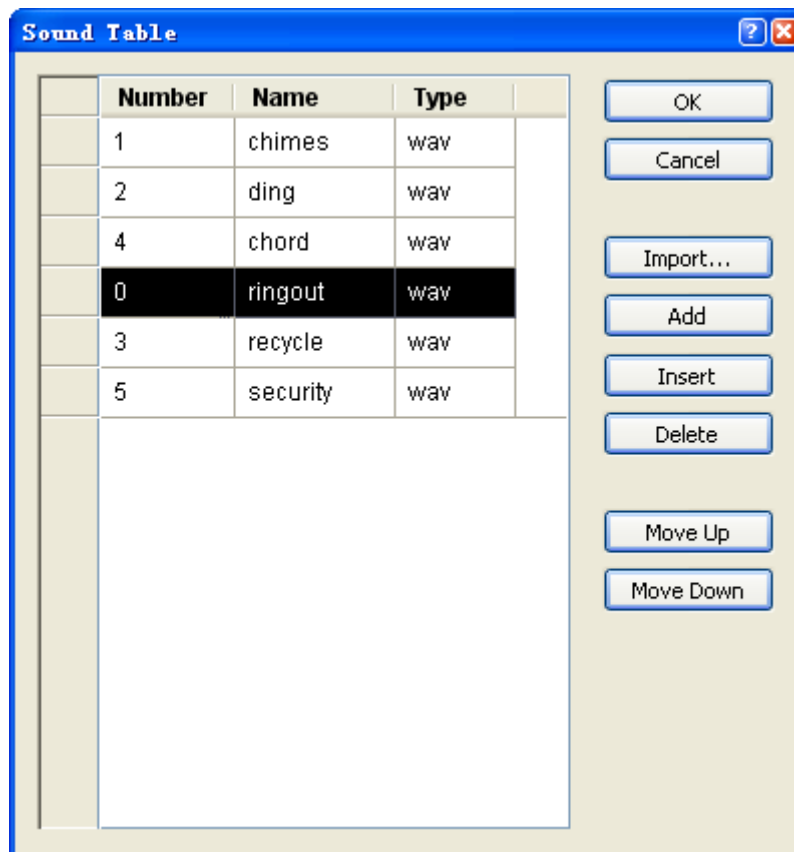

The following table describes how to read or use each of the items in the dialog box.

Item	Description								
Sounds	<p>Lists the sounds for the panel application. Select a sound as the current selection, or make multiple selections. To select a sound, click the row of the header column of the sound on the list. To select multiple rows, click the row of the header column and use Ctrl + Click to add a row to the selection.</p> <p>The following table describes each column in the sound list.</p> <table border="1"> <thead> <tr> <th>Column</th> <th>Description</th> </tr> </thead> <tbody> <tr> <td>Number</td> <td>The number of the sound in the sound list. The number is an unsigned integer starting from 0. It must be unique in the panel application. The number can be edited by clicking the cell.</td> </tr> <tr> <td>Name</td> <td>The name of the sound. Click the cell to select a predefined sound in the Sound Database from the drop down list. To know how to predefine sounds in the Sound Database, please see Section 2.2.4.</td> </tr> <tr> <td>Type</td> <td>Displays the type of sound.</td> </tr> </tbody> </table>	Column	Description	Number	The number of the sound in the sound list. The number is an unsigned integer starting from 0. It must be unique in the panel application. The number can be edited by clicking the cell.	Name	The name of the sound. Click the cell to select a predefined sound in the Sound Database from the drop down list. To know how to predefine sounds in the Sound Database, please see Section 2.2.4 .	Type	Displays the type of sound.
Column	Description								
Number	The number of the sound in the sound list. The number is an unsigned integer starting from 0. It must be unique in the panel application. The number can be edited by clicking the cell.								
Name	The name of the sound. Click the cell to select a predefined sound in the Sound Database from the drop down list. To know how to predefine sounds in the Sound Database, please see Section 2.2.4 .								
Type	Displays the type of sound.								
OK	Close the dialog box and accept all changes to the sound table.								
Cancel	Close the dialog box and discard all changes to the sound table.								
Import...	Import a sound from a sound file. The types of importable sound files include: WAV only.								
Add	Add a sound from the Sound Database to the end of the sound table. To know how to use the Sound Database, please see Section 2.2.4 .								
Insert	Insert a sound from the Sound Database before the selection. To know how to use Sound Database, please see Section 2.2.4 . This button is available when the selection is made.								
Delete	Delete all the selections. This button is available when the selection is made.								
Move Up	Move the selection one item down in the list. This button is available when the selection is made.								
Move Down	Move the selection one item up in the list. This button is available when the selection is made.								

3.6. Command Block and Status Words

You can command the panel to do a variety of things using the command block. The command block is a block of words in the controller or the internal memory. The panel scans the control block periodically and performs the specified operations according to the contents of the control block. You can decide the size of the command block, the command words that are required in the command block, and the rate of scanning the command block, so the overhead of reading the command block is minimized.

The panel can provide its status information by writing status values to the status words. The status words are in the controller or the internal memory. You can decide the status words that are required for your application so the panel will not waste time to output useless status values.

3.6.1. Types of Command Block and Status Words

There are three types of control blocks and status words that can be chosen for your application.

3.6.1.1. Type A

■ Type A Command Block

The following command words for the application and their order in the command block are adjustable.

Screen Switching Register

You can command the panel to change the main screen or display a window screen by setting this word to the number of the desired screen.

Command Flag Word (Command Flags #0 - #15)

The following table describes the function of each bit in the Command Flag Word.

Bit	Function	Description
0	(reserved)	
1	Switch Language	Change the language that the panel displays. Parameter One Register: Specifies the number of the desired language
2	Set Current Recipe Number	Set the current recipe number of the recipe block to the specified recipe number. Parameter One Register: Specifies the recipe number Parameter Two Register: Specifies the recipe block Note: You do not need to specify the recipe block if the application has only one recipe block.
3	Read Recipe From PLC	Read a recipe from the specified address defined in the Recipe Block dialog box, and use that recipe to replace the specified recipe of the specified recipe block. Parameter One Register: Specifies the recipe number Parameter Two Register: Specifies the recipe block Note: You do not need to specify the recipe block if the application has only one recipe block.
4	Write Recipe To PLC	Write the specified recipe of the specified recipe block to the specified address defined in the Recipe Block dialog box. Parameter One Register: Specifies the recipe number Parameter Two Register: Specifies the recipe block Note: You do not need to specify the recipe block if the application has only one recipe block.
5	Clear Alarm History	Clear the alarm history.

Continued

Bit	Function	Description												
6	Clear Alarm Count	Clear the alarm counts.												
7	Sound Buzzer	<p>Sound buzzer. Parameter One Register: Specifies the sound type.</p> <table border="1"> <thead> <tr> <th>Sound Type Value</th> <th>Description</th> </tr> </thead> <tbody> <tr> <td>0</td> <td>Continuous beep</td> </tr> <tr> <td>1</td> <td>500ms beeps</td> </tr> <tr> <td>2</td> <td>200ms beeps</td> </tr> <tr> <td>3</td> <td>100ms beeps</td> </tr> <tr> <td>4</td> <td>50ms beeps</td> </tr> </tbody> </table>	Sound Type Value	Description	0	Continuous beep	1	500ms beeps	2	200ms beeps	3	100ms beeps	4	50ms beeps
Sound Type Value	Description													
0	Continuous beep													
1	500ms beeps													
2	200ms beeps													
3	100ms beeps													
4	50ms beeps													
8	Print Screen	<p>Print the specified screen.</p> <table border="1"> <thead> <tr> <th>Parameter One Register</th> <th>Operation</th> </tr> </thead> <tbody> <tr> <td>(Undefined)</td> <td>Prints the top screen.</td> </tr> <tr> <td>0</td> <td>Prints the top screen.</td> </tr> <tr> <td>The number of the screen to be printed</td> <td>Prints the specified screen. Note: This operation is not supported by PL035/037/057/058</td> </tr> </tbody> </table>	Parameter One Register	Operation	(Undefined)	Prints the top screen.	0	Prints the top screen.	The number of the screen to be printed	Prints the specified screen. Note: This operation is not supported by PL035/037/057/058				
Parameter One Register	Operation													
(Undefined)	Prints the top screen.													
0	Prints the top screen.													
The number of the screen to be printed	Prints the specified screen. Note: This operation is not supported by PL035/037/057/058													
9	Backlight On	Turn the backlight on.												
10	Backlight Off	Turn the backlight off.												
11	Set Current User Level	Set the current user level to the specified level. Parameter One Register: the user level												
12	Close All Window Screens	Close all window screens.												
13	(reserved)													
14	(reserved)													
15	Execute General Command	See the section 3.6.7 Using General Commands for details.												

Note: To activate any of the above functions, change the corresponding command bit from Off to On. The panel does not reset the command bit, so you have to reset the command bit before commanding the panel to perform the same function again. Keep the state of the command bit long enough so the panel can detect the change. The best way is to use the corresponding acknowledge bit in the Command Status Word. The panel turns on the acknowledge bit when it detects the change. It is safe to reset the command bit when the acknowledge bit turns on. The panels turns off the acknowledge bit when it sees the command bit turn off.

Low Trigger Word (Trigger Bits #0 - #15), High Trigger Word (Trigger Bits #16 - #31)

You can use the trigger bits to initiate the following operations:

- 1) Asking the associated data loggers to collect data
- 2) Asking the associated data loggers to clear their logging buffers
- 3) Executing event macros
- 4) Increasing the clock by one hour
- 5) Decreasing the clock by one hour
- 6) Logging in
- 7) Logging out
- 8) Asking the associated line charts to read and draw a new set of data.
- 9) Asking the associated line charts to clear its content.
- 10) Asking the associated scatter charts to read and draw a new set of data.
- 11) Asking the associated scatter charts to clear its content.

Enabling Word (Enabling Bits #0 ~ #15)

You can use the enabling bits to enable the following operations:

- 1) The data collection of data loggers

Parameter One Register

This word specifies parameter #1 for the specified operation.

Parameter Two Register

This word specifies parameter #2 for the specified operation.

Parameter Three Register

This word specifies parameter #3 for the specified operation.

Parameter Four Register

This word specifies parameter #4 for the specified operation.

■ Type A Status Words

You can have the following status words for the application.

Status Word	Description
Command Status Word (Command Flag Ack. Bits #0 - #15)	Stores the acknowledge bits of the command bits #0 - #15.
Low Trigger Ack. Word (Trigger Ack. Bits #0 - #15)	Stores the acknowledge bits of the trigger bits #0 - #15.
High Trigger Ack. Word (Trigger Ack. Bits #16 - #31)	Stores the acknowledge bits of the trigger bits #16 - #31.
Current Screen Number Word	Stores the current main screen number.
Current Recipe Block ID Word	Stores the current recipe block number.
Current Recipe Number Word	Stores the current recipe number of the current recipe block.
Current User Level Word	Stores the current user level.
Current Language Word	Stores the current language number.

3.6.1.2. Type H (Binary)

■ Type H (Binary) Command Block

You can have the following command words for the application.

Screen Number Register

You can command the panel to change the main screen or display a window screen by setting this word to the number of the desired screen. Use this word to request the panel to 1) change the language, 2) turn on the backlight, and 3) turn off the backlight. The following table describes how to program this word.

Bit	Description
0-9	Specifies the screen to be displayed.
11-13	Specifies the language that the panel displays for. 000: The panel does nothing. 001: The panel changes the language to language 1. 010: The panel changes the language to language 2. ... 111: The panel changes the language to language 7.
14	If this bit is On, the panel turns off the back light of the display.
15	If this bit is On, the panel turns on the back light of the display.

Command Flag Register

The following table describes the function of each bit in the Command Flag Register.

Bit	Function
0	Clears the alarm history.
1	Clears the alarm counts.
2	(reserved)
3	(reserved)
4	Writes the current recipe of recipe block #0 to the address defined in the Recipe Block dialog box of recipe block #0.
5	Sets the current recipe number of recipe block #0 to the number specified in Recipe Number Register.
6	Reads the recipe from the address defined in the Recipe Block dialog box of recipe block #0, and use it to replace the current recipe of recipe block #0.
7	Turns on the buzzer.
8	Used as trigger bit #4.
9	Used as trigger bit #5.
10	Used as trigger bit #6.
11	Used as trigger bit #7.
12	Used as trigger bit #0.
13	Used as trigger bit #1.
14	Used as trigger bit #2.
15	Used as trigger bit #3.

Note: To activate any of the above functions, change the corresponding command bit from Off to On. The panel does not reset the command bit, so you have to reset the command bit before commanding the panel to perform the same function again. Keep the state of the command bit long enough so the panel can detect the change. The best way is to use the corresponding acknowledge bit in the Command Status Word. The panel turns on the acknowledge bit when it detects the change. It is safe to reset the command bit when the acknowledge bit turns on. The panels turns off the acknowledge bit when it sees the command bit turn off.

Recipe Number Register

The number in this word will be used as the current recipe number of recipe block #0 when bit 5 of Command Flag Register changes from Off to On.

■ Type H (Binary) Status Words

You can have the following status words for the application.

Status Word	Description
Screen Status Word	Whenever the panel switches the main screen, it sets this word to the number of the current main screen.
Command Flag Ack. Word	Contains the acknowledge bits for the command flags of Command Flag Register.
Current Recipe Number Word	Stores the current recipe number of recipe block #0.

3.6.1.3. Type H (BCD)

The command words and status words you can have for the application are the same as the H (Binary) type. However, the values in the following words must be in BCD format: Screen Number Register, Recipe Number Register, Screen Status Word, and Current Recipe Number Word.

3.6.2. General Settings

This section describes how to define the general settings for the command words and the status words using the General page of the Command & Status dialog box. The following is an example of the General page.

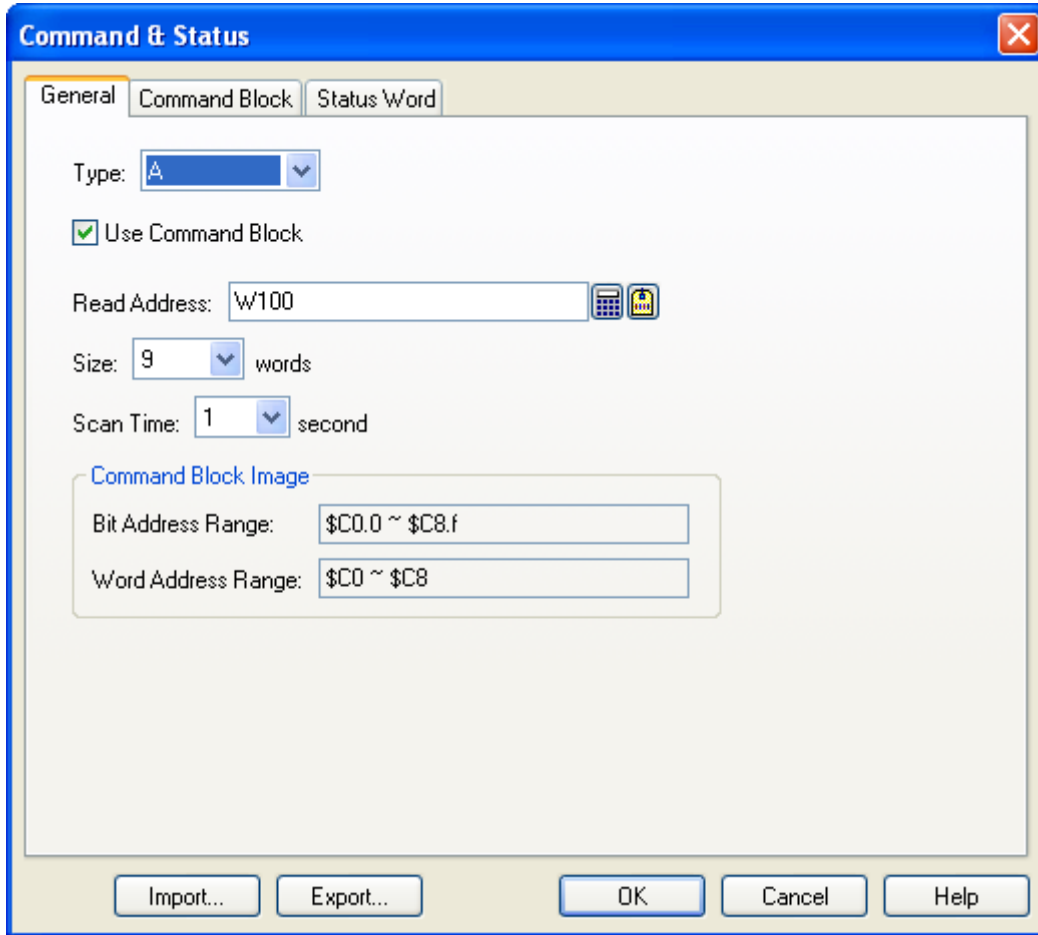

The following table describes each property in the General page.

Property		Description
Type		Select one of the following three types of control block and status words for your application: A, H (Binary), H (BCD)
Use Command Block		Check this item if the application needs any of the command words.
Read Address		Specify the address of the command block.
Size		Specify the size of the command block.
Scan Time		Select one of the following rates for the panel to scan the command block: 1 second, 0.5 second, 0.25 second
Command Block Image	Bit Address Range	Show the valid address range of the bits in the command block. Note that the application can only read the bits.
	Word Address Range	Show the valid address range of the words in the command block. Note that the application can only read the words.

3.6.3. Command Block Settings (Type A)

This section describes how to configure the type A command block using the Command Block page of the Command & Status dialog box. The following is an example of the Command Block page.

The following table describes each property in the Command Block page.

Property	Description	
Command Word	Arrangement	Select Default for the command words to be in the default order in the command block. Select Custom to arrange each command word in the command block by yourself.
	Screen Switching Register	Check this option to use the word to change the main screen, or display a window screen by setting the word to the number of the desired screen.
	Reset SSR to Zero	If this option is selected, the panel always resets the Screen Switching Register to zero when it detects a nonzero value in the word. If this option is not selected, the panel resets the Screen Switching Register to zero only when the specified screen is valid and not yet displayed.
	Parameter One Register	Check this option to use this word to specify the No. 1 parameter for the specified operation.
	Command Flags #0 - #15 (Command Flag Word)	Check this option to use the command flags to request the panel to perform the specified operations.
	Trigger Bits #0 - #15 (Low Trigger Word)	Check this option if any of the trigger bits in the word are needed for your application.
	Parameter Two Register	Check this option to use this word to specify the No. 2 parameter for the specified operation.
	Trigger Bits #16 - #31 (High Trigger Word)	Check this option if any of the trigger bits in the word are needed for your application.

Continued

Property		Description											
Command Word	Enabling Bits #0 - #15 (Enabling Word)	Check this option if any of the enabling bits in the word are needed for your application.											
	Parameter Three Register	Check this option to use this word to specify the No. 3 parameter for the specified operation.											
	Parameter Four Register	Check this option to use this word to specify the No. 4 parameter for the specified operation.											
Command Flag	Switch Language (#1)	Check this option to use command flag #1 to request the panel to display the specified language. Specify the following: 1) Parameter One Register: the number of the desired language											
	Set Current Recipe Number (#2)	Check this option to use command flag #2 to request the panel to set the current recipe number of the specified recipe block to the specified recipe number. Specify the following: 1) Parameter One Register: The recipe number 2) Parameter Two Register: The recipe block Note: You do not need to specify the recipe block if the application has only one recipe block.											
	Read Recipe From PLC (#3)	Check this option to use command flag #3 to request the panel to read a recipe from the specified address defined in the Recipe Block dialog box, and use that recipe to replace the specified recipe of the specified recipe block. Specify the following: 1) Parameter One Register: The recipe number 2) Parameter Two Register: The recipe block Note: You do not need to specify the recipe block if the application has only one recipe block.											
	Write Recipe To PLC (#4)	Check this option to use command flag #4 to request the panel to write the specified recipe of the specified recipe block to the specified address defined in the Recipe Block dialog box. Specify the following: 1) Parameter One Register: The recipe number 2) Parameter Two Register: The recipe block Note: You do not need to specify the recipe block if the application has only one recipe block.											
	Clear Alarm History (#5)	Check this option to use command flag #5 to request the panel to clear the alarm history.											
	Clear Alarm Count (#6)	Check this option to use command flag #6 to request the panel to clear the alarm counts.											
	Sound Buzzer (#7)	Check this option to use command flag #7 to request the panel to sound its buzzer in the specified manner. Specify the following: 1) Parameter One Register: The sound type. The following table describes the sound type value. <table border="1" data-bbox="614 1630 1433 1888"> <thead> <tr> <th>Sound Type Value</th> <th>Description</th> </tr> </thead> <tbody> <tr> <td>0</td> <td>Continuous beep</td> </tr> <tr> <td>1</td> <td>500ms beeps</td> </tr> <tr> <td>2</td> <td>200ms beeps</td> </tr> <tr> <td>3</td> <td>100ms beeps</td> </tr> <tr> <td>4</td> <td>50ms beeps</td> </tr> </tbody> </table>	Sound Type Value	Description	0	Continuous beep	1	500ms beeps	2	200ms beeps	3	100ms beeps	4
Sound Type Value	Description												
0	Continuous beep												
1	500ms beeps												
2	200ms beeps												
3	100ms beeps												
4	50ms beeps												

Continued

Property		Description
Command Flag	Print Screen (#8)	Check this option to use command flag #8 to request the panel to print the specified screen. Specify the following: 1) Parameter One Register: the number of the screen to be printed Note 1: The top screen is printed if the number is zero or if there is no Parameter One Register. Note 2: The operation of printing a screen that is not the top screen is not supported by PL035/037/057/058
	Backlight On (#9)	Check this option to use command flag #9 to request the panel to turn its backlight on.
	Backlight Off (#10)	Check this option to use command flag #10 to request the panel to turn its backlight off.
	Set Current User Level (#11)	Check this option to use command flag #11 to request the panel to set the current user level to the specified one. Specify the following: 1) Parameter One Register: the user level
	Close All Window Screens (#12)	Check this option to use command flag #12 to request the panel to close all window screens.
	Execute General Command (#15)	Check this option to use command flag #15 to request the panel to perform the specified operation. See the section 3.6.7 Using General Commands for details.

3.6.4. Status Word Settings (Type A)

This section describes how to configure the type A status words for your application using the Status Word page of the Command & Status dialog box. The following is an example of the Status Word page.

Status Word	Word Variable
<input checked="" type="checkbox"/> Command Flag Ack. Bits #0 ~ #15	R100
<input checked="" type="checkbox"/> Trigger Ack. Bits #0 ~ #15	R101
<input type="checkbox"/> Trigger Ack. Bits #16 ~ #31	
<input checked="" type="checkbox"/> Current Screen Number Word	R102
<input type="checkbox"/> Current Recipe Block ID Word	
<input type="checkbox"/> Current Recipe Number Word	
<input checked="" type="checkbox"/> Current User Level Word	R103
<input checked="" type="checkbox"/> Current Language Word	R104

In the Status Word page, check the needed status words for your application, and specify a word variable that will receive the status value for each checked status word.

The following table describes when and what the panel will write to each status word.

Status Word	Description
Command Flag Ack. Bits #0 - #15	The states of all the effective command flags to this word whenever a state change occurs on the effective command flags.
Trigger Ack. Bits #0 - #15	The states of trigger bits #0 - #15 to this word whenever a state change occurs on trigger bits #0 - #15.
Trigger Ack. Bits #16 - #31	The states of trigger bits #16 - #31 to this word whenever a state change occurs on trigger bits #16 - #31.
Current Screen Number Word	The number of the current main screen to this word whenever the main screen changes.
Current Recipe Block ID Word	The current recipe block ID to this word whenever a different recipe block becomes the current recipe block.
Current Recipe Number Word	The current recipe number of the current recipe block to this word whenever a different recipe becomes the current recipe of the current recipe block.
Current User Level Word	The current user level to this word whenever the current user level changes.
Current Language Word	The current language number to this word whenever it changes the language.

3.6.5. Command Block Settings (Type H)

This section describes how to configure the type H command block using the Command Block page of the Command & Status dialog box. The following is an example of the Command Block page.

The following table describes each property in the Command Block page.

Property		Description										
Command Block	Screen Number Register	Use the word to change the main screen, or display a window screen by setting the word to the number of the desired screen. You can also use this word to request the panel to do the following operations: 1) Change the language, 2) Turn on the backlight, and 3) Turn off the backlight. The following table describes how to program this word.										
		<table border="1"> <thead> <tr> <th>Bit</th> <th>Description</th> </tr> </thead> <tbody> <tr> <td>0-9</td> <td>Specifies the screen to be displayed.</td> </tr> <tr> <td>11-13</td> <td>Specifies the language that the panel displays for. 000: The panel does nothing. 001: The panel changes the language to language 1. 010: The panel changes the language to language 2. ... 111: The panel changes the language to language 7.</td> </tr> <tr> <td>14</td> <td>If this bit is On, the panel turns off the back light of the display.</td> </tr> <tr> <td>15</td> <td>If this bit is On, the panel turns on the back light of the display.</td> </tr> </tbody> </table>	Bit	Description	0-9	Specifies the screen to be displayed.	11-13	Specifies the language that the panel displays for. 000: The panel does nothing. 001: The panel changes the language to language 1. 010: The panel changes the language to language 2. ... 111: The panel changes the language to language 7.	14	If this bit is On, the panel turns off the back light of the display.	15	If this bit is On, the panel turns on the back light of the display.
		Bit	Description									
		0-9	Specifies the screen to be displayed.									
		11-13	Specifies the language that the panel displays for. 000: The panel does nothing. 001: The panel changes the language to language 1. 010: The panel changes the language to language 2. ... 111: The panel changes the language to language 7.									
14	If this bit is On, the panel turns off the back light of the display.											
15	If this bit is On, the panel turns on the back light of the display.											

Continued

Property		Description
	Reset SNR to Zero	If this option is selected, the panel always resets the Screen Number Register to zero when it detects a nonzero value in the word. If this option is not selected, the panel resets the Screen Number Register to zero only when the specified screen is valid and not displayed yet.
	Command Flag Register	Use the command flags to request the panel to do the specified operations.
	Recipe Number Register	Use command flag #5 to set the current recipe number for recipe block #0, specify the recipe number in this word.
Command Flag	Clear Alarm History (#0)	Check this option to use command flag #0 to request the panel to clear the alarm history.
	Clear Alarm Counts (#1)	Check this option to use command flag #1 to request the panel to clear the alarm counts.
	Write Recipe To PLC (#4)	Check this option to use command flag #4 to request the panel to write the current recipe of recipe block #0 to the specified address defined in the Recipe Block dialog box.
	Set Current Recipe Number (#5)	Check this option to use command flag #5 to request the panel to set the current recipe number for recipe block #0. Specify the following: 1) Recipe Number Register: the recipe number
	Read Recipe From PLC (#6)	Check this option to use command flag #6 to request the panel to read a recipe from the specified address defined in the Recipe Block dialog box, and use that recipe to replace the current recipe of recipe block #0.
	Sound Buzzer (#7)	Check this option to use command flag #7 to request the panel to sound its buzzer.
	Trigger Bit #4 (#8)	Check this option so command flag #8 will be used as trigger bit #4.
	Trigger Bit #5 (#9)	Check this option so command flag #9 will be used as trigger bit #5.
	Trigger Bit #6 (#10)	Check this option so command flag #10 will be used as trigger bit #6.
	Trigger Bit #7 (#11)	Check this option so command flag #11 will be used as trigger bit #7.
	Trigger Bit #0 (#12)	Check this option so command flag #12 will be used as trigger bit #0.
	Trigger Bit #1 (#13)	Check this option so command flag #13 will be used as trigger bit #1.
	Trigger Bit #2 (#14)	Check this option so command flag #14 will be used as trigger bit #2.
Trigger Bit #3 (#15)	Check this option so command flag #15 will be used as trigger bit #3.	

3.6.6. Status Word Settings (Type H)

This section describes how to configure the type H status words for your application using the Status Word page of the Command & Status dialog box. The following is an example of the Status Word page.

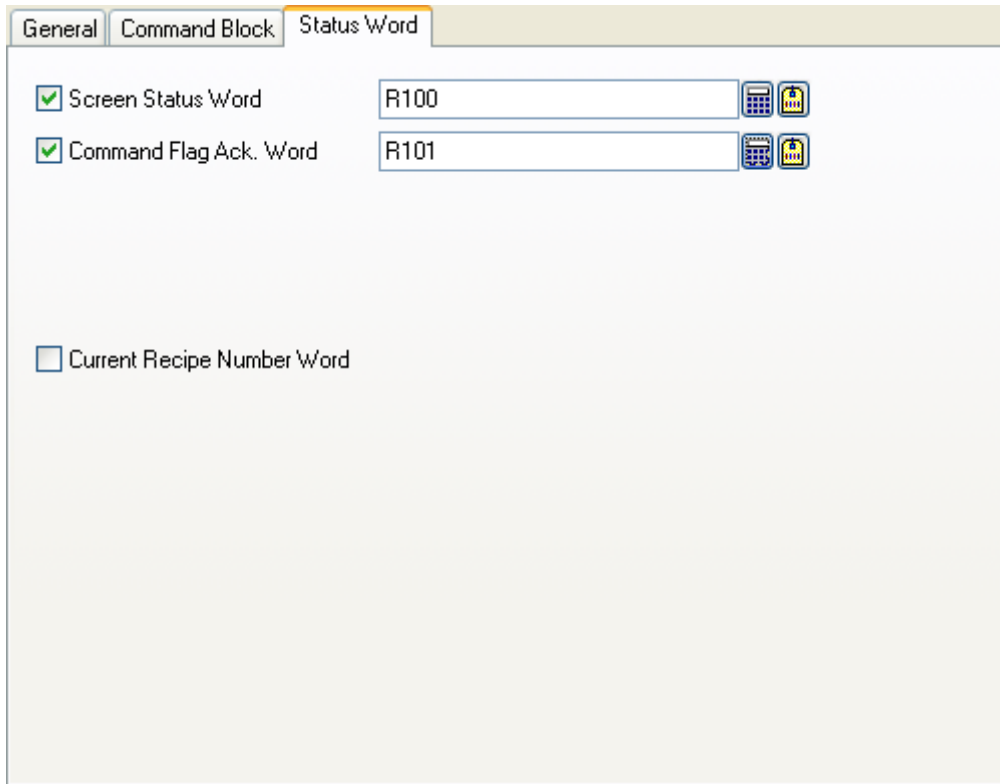

The screenshot shows a dialog box with three tabs: 'General', 'Command Block', and 'Status Word'. The 'Status Word' tab is active. It contains three status word settings:

- Screen Status Word: R100
- Command Flag Ack. Word: R101
- Current Recipe Number Word

In the Status Word page, check the needed status words for your application and specify a word variable that will receive the status value for each checked status word.

The following table describes when and what the panel will write to each status word.

Status Word	Description
Screen Status Word	The panel will write the number of the current main screen to this word whenever the main screen changes.
Command Flag Ack. Word	The panel will write the states of all the effective command flags to this word whenever there a state change occurs on the effective command flags.
Current Recipe Number Word	The panel will write the current recipe number of recipe block #0 to this word whenever a different recipe becomes the current recipe of recipe block #0.

3.6.7. Using General Commands

This section describes how to use the general commands provided by the type A command block. To issue a general command, specify necessary parameters in the parameter registers and then turn on command flag #15 in Command Flag Register.

You can request the panel to perform the following file operations using the General Command and the default filename:

Operation	Parameter One Register (Operation code)	Parameter Two Register (Data ID)	Default Filename Format
Save logged data to TXT file	1	ID of the data logger (0-15)	DL<ID>_<Date>_<Time>.txt
Save logged data to CSV file	14	ID of the data logger (0-15)	DL<ID>_<Date>_<Time>.csv
Save logged alarms to TXT file	2	(Not required)	AL_<Date>_<Time>.txt
Save logged alarms to CSV file	15	(Not required)	AL_<Date>_<Time>.csv
Save alarm counts to TXT file	3	(Not required)	AC_<Date>_<Time>.txt
Save alarm counts to CSV file	16	(Not required)	AC_<Date>_<Time>.csv
Save recipe data to TXT file	4	ID of the recipe block (0-15)	RB<ID>.txt
Save recipe data to CSV file	17	ID of the recipe block (0-15)	RB<ID>.csv
Save recipe data to DAT file	5	ID of the recipe block (0-15)	RB<ID>.dat
Print screen to BMP file (256 colors) If the target panel is PE, the color resolution follows the setting of the PC	6	Number of the screen	S<ID>_<Date>_<Time>.bmp
Print screen to BMP file (64K colors) If the target panel is PE, Print screen to JPG file	7	Number of the screen	S<ID>_<Date>_<Time>.bmp
Save logged operations to TXT file	9	(Not required)	OL_<Date>_<Time>.txt
Save logged operations to CSV file	18	(Not required)	OL_<Date>_<Time>.csv
Save logged data to LDF file	10	ID of the data logger (0-15)	DL<ID>_<Date>_<Time>.ldf
Take picture and save it to BMP file	12	ID of the USB camera (0-3)	CAM<ID>_<Date>_<Time>.bmp
Take picture and save it to JPG file	13	ID of the USB camera (0-3)	CAM<ID>_<Date>_<Time>.jpg

Note for default filename format:

<ID>: ID of the data logger, ID of the recipe block, ID of the USB camera, or number of the screen

<Date>: date when saving the data; format is YYMMDD

<Time>: time when saving the data; format is hhmmss

You can request the panel to perform the following file operations using the General Command and the specified filename:

Operation	Parameter One Register (Operation code)	Parameter Two Register (Data ID)	Parameter Three Register (Specified filename)
Save logged data to TXT file	31	ID of the data logger (0-15)	Specifies the address in the internal memory \$U that stores the specified filename or full pathname. The name must be a valid Windows pathname with ASCII characters only. The character string must be null terminated and each character occupies one byte. The maximum length of the string is 127. All the folders stated in the full pathname must already exist or the file operation will fail. For example, if the number stored in this register is 400, it means the specified filename is stored in \$U400.
Save logged alarms to TXT file	32	(Not required)	Same as above
Save alarm counts to TXT file	33	(Not required)	Same as above
Save recipe data to TXT file	34	ID of the recipe block (0-15)	Same as above
Save recipe data to DAT file	35	ID of the recipe block (0-15)	Same as above
Save logged operations to TXT file	39	(Not required)	Same as above
Save logged data to LDF file	40	ID of the data logger (0-15)	Same as above
Take picture and save it to BMP file	42	ID of the USB camera (0-3)	Same as above
Take picture and save it to JPG file	43	ID of the USB camera (0-3)	Same as above

3.7. Setting up Clock Operations

This section describes how to define Clock Operations for the panel application using the Clock dialog box. The following is an example of the Clock dialog box.

The following table describes each property in the Clock dialog box.

Property		Description																	
Write	Write Time/date to PLC	Select this option so the panel will write time and date information to the specified variable.																	
	Time/date Data Type	Select one of the following data types for the output time and data information. <table border="1" data-bbox="512 1370 1474 1798"> <thead> <tr> <th>Data Type</th> <th>Description</th> </tr> </thead> <tbody> <tr> <td>6 BCD bytes</td> <td>The following shows the data structure. <table border="1" data-bbox="751 1458 1434 1756"> <thead> <tr> <th>Byte No.</th> <th>Content</th> </tr> </thead> <tbody> <tr> <td>0</td> <td>Minute; 0-59</td> </tr> <tr> <td>1</td> <td>Hour; 0-23</td> </tr> <tr> <td>2</td> <td>Day; 1-31</td> </tr> <tr> <td>3</td> <td>Month; 1-12</td> </tr> <tr> <td>4</td> <td>Year; 00-99</td> </tr> <tr> <td>5</td> <td>Day-of-week; 0(Sunday)-6(Saturday)</td> </tr> </tbody> </table> <p>Note: All the values are in BCD format.</p> </td> </tr> </tbody> </table>	Data Type	Description	6 BCD bytes	The following shows the data structure. <table border="1" data-bbox="751 1458 1434 1756"> <thead> <tr> <th>Byte No.</th> <th>Content</th> </tr> </thead> <tbody> <tr> <td>0</td> <td>Minute; 0-59</td> </tr> <tr> <td>1</td> <td>Hour; 0-23</td> </tr> <tr> <td>2</td> <td>Day; 1-31</td> </tr> <tr> <td>3</td> <td>Month; 1-12</td> </tr> <tr> <td>4</td> <td>Year; 00-99</td> </tr> <tr> <td>5</td> <td>Day-of-week; 0(Sunday)-6(Saturday)</td> </tr> </tbody> </table> <p>Note: All the values are in BCD format.</p>	Byte No.	Content	0	Minute; 0-59	1	Hour; 0-23	2	Day; 1-31	3	Month; 1-12	4	Year; 00-99	5
Data Type	Description																		
6 BCD bytes	The following shows the data structure. <table border="1" data-bbox="751 1458 1434 1756"> <thead> <tr> <th>Byte No.</th> <th>Content</th> </tr> </thead> <tbody> <tr> <td>0</td> <td>Minute; 0-59</td> </tr> <tr> <td>1</td> <td>Hour; 0-23</td> </tr> <tr> <td>2</td> <td>Day; 1-31</td> </tr> <tr> <td>3</td> <td>Month; 1-12</td> </tr> <tr> <td>4</td> <td>Year; 00-99</td> </tr> <tr> <td>5</td> <td>Day-of-week; 0(Sunday)-6(Saturday)</td> </tr> </tbody> </table> <p>Note: All the values are in BCD format.</p>	Byte No.	Content	0	Minute; 0-59	1	Hour; 0-23	2	Day; 1-31	3	Month; 1-12	4	Year; 00-99	5	Day-of-week; 0(Sunday)-6(Saturday)				
Byte No.	Content																		
0	Minute; 0-59																		
1	Hour; 0-23																		
2	Day; 1-31																		
3	Month; 1-12																		
4	Year; 00-99																		
5	Day-of-week; 0(Sunday)-6(Saturday)																		

Continued

Property		Description																																																																		
Write	Time/date Data Type	<table border="1"> <thead> <tr> <th>Data Type</th> <th>Description</th> </tr> </thead> <tbody> <tr> <td>8 BCD bytes</td> <td> <p>The following shows the data structure.</p> <table border="1"> <thead> <tr> <th>Byte No.</th> <th>Content</th> </tr> </thead> <tbody> <tr> <td>0</td> <td>Minute; 0-59</td> </tr> <tr> <td>1</td> <td>Hour; 0-23</td> </tr> <tr> <td>2</td> <td>Day; 1-31</td> </tr> <tr> <td>3</td> <td>Month; 1-12</td> </tr> <tr> <td>4</td> <td>Year; 00-99</td> </tr> <tr> <td>5</td> <td>Day-of-week; 0(Sunday)-6(Saturday)</td> </tr> <tr> <td>6</td> <td>Second; 0-59</td> </tr> <tr> <td>7</td> <td>0</td> </tr> </tbody> </table> <p>Note: All the values are in BCD format.</p> </td> </tr> <tr> <td>7 BCD words</td> <td> <p>The following shows the data structure.</p> <table border="1"> <thead> <tr> <th>Word No.</th> <th>Content</th> </tr> </thead> <tbody> <tr> <td>0</td> <td>Second; 0-59</td> </tr> <tr> <td>1</td> <td>Minute; 0-59</td> </tr> <tr> <td>2</td> <td>Hour; 0-23</td> </tr> <tr> <td>3</td> <td>Day; 1-31</td> </tr> <tr> <td>4</td> <td>Month; 1-12</td> </tr> <tr> <td>5</td> <td>Year; 00-99</td> </tr> <tr> <td>6</td> <td>Day-of-week; 0(Sunday)-6(Saturday)</td> </tr> </tbody> </table> <p>Note: All the values are in BCD format.</p> </td> </tr> <tr> <td>7 binary words</td> <td> <p>The following shows the data structure.</p> <table border="1"> <thead> <tr> <th>Word No.</th> <th>Content</th> </tr> </thead> <tbody> <tr> <td>0</td> <td>Second; 0-59</td> </tr> <tr> <td>1</td> <td>Minute; 0-59</td> </tr> <tr> <td>2</td> <td>Hour; 0-23</td> </tr> <tr> <td>3</td> <td>Day; 1-31</td> </tr> <tr> <td>4</td> <td>Month; 1-12</td> </tr> <tr> <td>5</td> <td>Year; 00-99</td> </tr> <tr> <td>6</td> <td>Day-of-week; 0(Sunday)-6(Saturday)</td> </tr> </tbody> </table> </td> </tr> <tr> <td colspan="2">Write Address</td> <td>Specifies the variable that will receive the output time and date information.</td> </tr> <tr> <td rowspan="2">Write Operation</td> <td>Timed</td> <td>When this item is selected, the panel writes time and date information to the specified variable periodically at a rate specified in the Interval field. Specify an interval between 1 and 255 minutes.</td> </tr> <tr> <td>Triggered</td> <td>When this item is selected, the panel writes time and date information to the specified variable whenever the specified trigger bit changes from Off to On.</td> </tr> </tbody> </table>	Data Type	Description	8 BCD bytes	<p>The following shows the data structure.</p> <table border="1"> <thead> <tr> <th>Byte No.</th> <th>Content</th> </tr> </thead> <tbody> <tr> <td>0</td> <td>Minute; 0-59</td> </tr> <tr> <td>1</td> <td>Hour; 0-23</td> </tr> <tr> <td>2</td> <td>Day; 1-31</td> </tr> <tr> <td>3</td> <td>Month; 1-12</td> </tr> <tr> <td>4</td> <td>Year; 00-99</td> </tr> <tr> <td>5</td> <td>Day-of-week; 0(Sunday)-6(Saturday)</td> </tr> <tr> <td>6</td> <td>Second; 0-59</td> </tr> <tr> <td>7</td> <td>0</td> </tr> </tbody> </table> <p>Note: All the values are in BCD format.</p>	Byte No.	Content	0	Minute; 0-59	1	Hour; 0-23	2	Day; 1-31	3	Month; 1-12	4	Year; 00-99	5	Day-of-week; 0(Sunday)-6(Saturday)	6	Second; 0-59	7	0	7 BCD words	<p>The following shows the data structure.</p> <table border="1"> <thead> <tr> <th>Word No.</th> <th>Content</th> </tr> </thead> <tbody> <tr> <td>0</td> <td>Second; 0-59</td> </tr> <tr> <td>1</td> <td>Minute; 0-59</td> </tr> <tr> <td>2</td> <td>Hour; 0-23</td> </tr> <tr> <td>3</td> <td>Day; 1-31</td> </tr> <tr> <td>4</td> <td>Month; 1-12</td> </tr> <tr> <td>5</td> <td>Year; 00-99</td> </tr> <tr> <td>6</td> <td>Day-of-week; 0(Sunday)-6(Saturday)</td> </tr> </tbody> </table> <p>Note: All the values are in BCD format.</p>	Word No.	Content	0	Second; 0-59	1	Minute; 0-59	2	Hour; 0-23	3	Day; 1-31	4	Month; 1-12	5	Year; 00-99	6	Day-of-week; 0(Sunday)-6(Saturday)	7 binary words	<p>The following shows the data structure.</p> <table border="1"> <thead> <tr> <th>Word No.</th> <th>Content</th> </tr> </thead> <tbody> <tr> <td>0</td> <td>Second; 0-59</td> </tr> <tr> <td>1</td> <td>Minute; 0-59</td> </tr> <tr> <td>2</td> <td>Hour; 0-23</td> </tr> <tr> <td>3</td> <td>Day; 1-31</td> </tr> <tr> <td>4</td> <td>Month; 1-12</td> </tr> <tr> <td>5</td> <td>Year; 00-99</td> </tr> <tr> <td>6</td> <td>Day-of-week; 0(Sunday)-6(Saturday)</td> </tr> </tbody> </table>	Word No.	Content	0	Second; 0-59	1	Minute; 0-59	2	Hour; 0-23	3	Day; 1-31	4	Month; 1-12	5	Year; 00-99	6	Day-of-week; 0(Sunday)-6(Saturday)	Write Address		Specifies the variable that will receive the output time and date information.	Write Operation	Timed	When this item is selected, the panel writes time and date information to the specified variable periodically at a rate specified in the Interval field. Specify an interval between 1 and 255 minutes.	Triggered	When this item is selected, the panel writes time and date information to the specified variable whenever the specified trigger bit changes from Off to On.
		Data Type	Description																																																																	
		8 BCD bytes	<p>The following shows the data structure.</p> <table border="1"> <thead> <tr> <th>Byte No.</th> <th>Content</th> </tr> </thead> <tbody> <tr> <td>0</td> <td>Minute; 0-59</td> </tr> <tr> <td>1</td> <td>Hour; 0-23</td> </tr> <tr> <td>2</td> <td>Day; 1-31</td> </tr> <tr> <td>3</td> <td>Month; 1-12</td> </tr> <tr> <td>4</td> <td>Year; 00-99</td> </tr> <tr> <td>5</td> <td>Day-of-week; 0(Sunday)-6(Saturday)</td> </tr> <tr> <td>6</td> <td>Second; 0-59</td> </tr> <tr> <td>7</td> <td>0</td> </tr> </tbody> </table> <p>Note: All the values are in BCD format.</p>	Byte No.	Content	0	Minute; 0-59	1	Hour; 0-23	2	Day; 1-31	3	Month; 1-12	4	Year; 00-99	5	Day-of-week; 0(Sunday)-6(Saturday)	6	Second; 0-59	7	0																																															
		Byte No.	Content																																																																	
0	Minute; 0-59																																																																			
1	Hour; 0-23																																																																			
2	Day; 1-31																																																																			
3	Month; 1-12																																																																			
4	Year; 00-99																																																																			
5	Day-of-week; 0(Sunday)-6(Saturday)																																																																			
6	Second; 0-59																																																																			
7	0																																																																			
7 BCD words	<p>The following shows the data structure.</p> <table border="1"> <thead> <tr> <th>Word No.</th> <th>Content</th> </tr> </thead> <tbody> <tr> <td>0</td> <td>Second; 0-59</td> </tr> <tr> <td>1</td> <td>Minute; 0-59</td> </tr> <tr> <td>2</td> <td>Hour; 0-23</td> </tr> <tr> <td>3</td> <td>Day; 1-31</td> </tr> <tr> <td>4</td> <td>Month; 1-12</td> </tr> <tr> <td>5</td> <td>Year; 00-99</td> </tr> <tr> <td>6</td> <td>Day-of-week; 0(Sunday)-6(Saturday)</td> </tr> </tbody> </table> <p>Note: All the values are in BCD format.</p>	Word No.	Content	0	Second; 0-59	1	Minute; 0-59	2	Hour; 0-23	3	Day; 1-31	4	Month; 1-12	5	Year; 00-99	6	Day-of-week; 0(Sunday)-6(Saturday)																																																			
Word No.	Content																																																																			
0	Second; 0-59																																																																			
1	Minute; 0-59																																																																			
2	Hour; 0-23																																																																			
3	Day; 1-31																																																																			
4	Month; 1-12																																																																			
5	Year; 00-99																																																																			
6	Day-of-week; 0(Sunday)-6(Saturday)																																																																			
7 binary words	<p>The following shows the data structure.</p> <table border="1"> <thead> <tr> <th>Word No.</th> <th>Content</th> </tr> </thead> <tbody> <tr> <td>0</td> <td>Second; 0-59</td> </tr> <tr> <td>1</td> <td>Minute; 0-59</td> </tr> <tr> <td>2</td> <td>Hour; 0-23</td> </tr> <tr> <td>3</td> <td>Day; 1-31</td> </tr> <tr> <td>4</td> <td>Month; 1-12</td> </tr> <tr> <td>5</td> <td>Year; 00-99</td> </tr> <tr> <td>6</td> <td>Day-of-week; 0(Sunday)-6(Saturday)</td> </tr> </tbody> </table>	Word No.	Content	0	Second; 0-59	1	Minute; 0-59	2	Hour; 0-23	3	Day; 1-31	4	Month; 1-12	5	Year; 00-99	6	Day-of-week; 0(Sunday)-6(Saturday)																																																			
Word No.	Content																																																																			
0	Second; 0-59																																																																			
1	Minute; 0-59																																																																			
2	Hour; 0-23																																																																			
3	Day; 1-31																																																																			
4	Month; 1-12																																																																			
5	Year; 00-99																																																																			
6	Day-of-week; 0(Sunday)-6(Saturday)																																																																			
Write Address		Specifies the variable that will receive the output time and date information.																																																																		
Write Operation	Timed	When this item is selected, the panel writes time and date information to the specified variable periodically at a rate specified in the Interval field. Specify an interval between 1 and 255 minutes.																																																																		
	Triggered	When this item is selected, the panel writes time and date information to the specified variable whenever the specified trigger bit changes from Off to On.																																																																		

Continued

Property		Description
Read	Synchronize Panel with PLC	Select this option so the panel will read time and date information from the specified variable and adjust its clock accordingly.
	Time/date Data Type	Specifies the data type for the input time and date information. For details, see the description of the Time/date Data Type field of the Write group.
	Read Address	Specifies the variable that the panel will read the time and date information.
	Do not run panel application until the restart synchronization is done successfully	Select this option so the panel application does not run until the restart synchronization is done successfully.
	Read Operation	Timed
Triggered		When this item is selected, the panel reads time and date information from the specified variable whenever the specified trigger bit changes from Off to On.
Increase Hour		Select this option to increase the panel's clock by one, by changing the specified trigger bit from Off to On.
Decrease Hour		Select this option to decrease the panel's clock by one, by changing the specified trigger bit from Off to On.

3.8. Setting up Passwords

This section describes how to set up passwords for the panel application using the Passwords dialog box. The following is an example of the Passwords dialog box.

User Level	Password	Comment
1	1	Operator
2	22	
3	333	
4	4444	
5	55555	
6	666666	
7	7777777	Maintenance
8	88888888	Executive
<input checked="" type="checkbox"/> 9	Use developer password	

Automatic login for operations requiring a higher user level

Login Trigger Bit: #7

Logout Trigger Bit: #8

Login Timeout: 30 seconds

The following table describes each property in the Passwords dialog box.

Property	Description
Password	The Password column contains 8 fields. Specify the password for a user level in the corresponding field. A password is a positive integer up to 8 digits. A password must be unique within the application.
Comment	The Comment column contains 8 editable fields. You can type the comment for a password or user level in the corresponding field.
9	Check this item if you want the developer password to be the password with the highest privilege.
Automatic login for operations requiring a higher user level	The password keypad will be displayed to enter a password for a higher user level when the operator touches an object that requires a higher user level than the current one in order to perform the programmed operation.
Login Trigger Bit	When the specified trigger bit changes from Off to On, the password keypad will be displayed to enter a password. The operator can enter a valid password or cancel the password keypad.
Logout Trigger Bit	When the specified trigger bit changes from Off to On, the current user level is reset to 0.
Login Timeout	The password keypad will close automatically when it gets no input from the operator for the specified time.

3.9. Screens

3.9.1. Types of Screens

There are three types of screens: Normal Screen, Window Screen and Menu Screen.

To create any type of screen, you can do the following:

- 1) Create a screen. Default is a normal screen. To learn how to create a screen, please see [Section 3.9.2](#) for details.
- 2) Open Screen Properties dialog box. To learn how to open the dialog box, please see [Section 3.9.3](#) for details.
- 3) In the dialog box, select the type you would like the screen to be.

The following table describes how each type of screen opens, closes, and displays.

Types	Description
Normal Screen	<p>A screen that will be displayed when it is selected to be a startup screen, or when a screen button with open screen/previous screen operation is pressed.</p> <p>Usually the normal screen cannot be closed until the other normal screen is opened.</p> <p>The normal screen is also called a main screen that is only displayed one at a time in the panel. The screen size is fixed and depends on the panel model.</p>
Window Screen	<p>A screen that appears in the following situations:</p> <ul style="list-style-type: none"> • Screen button with open screen operation is pressed • Selected to be a startup screen • OPEN_WS macro command is used. • Alarm is active or clear when the display screen option in the discrete/analog alarm block is selected • Page selector object is used • Custom keypad is needed <p>Usually the window screen stays on the normal screen until the close button is pressed on the title bar or the screen button or CLOSE_WS macro command to close. It then disappears.</p> <p>The panel can display many window screens at a time.</p> <p>At runtime, the window screen will initially be displayed at the predefined position. If the window screen has the title bar, click-and-hold the title bar to move it around in the panel.</p>
Menu Screen	<p>A screen that is displayed when it is selected to be a startup screen, or when a screen button with the open screen operation is pressed.</p> <p>The menu screen remains on the normal screen or window screen, until an area outside the menu screen is pressed, or the screen button is used to close the menu screen. The menu screen then closes.</p> <p>The panel can display one menu screen at a time.</p> <p>The menu screen can slide horizontally into view from either the left or right side of the screen. It can also appear by the left or right side of the button and slide upward or downward into view. Please see Section 5.3.4 to learn how to use the screen button to set up the position of the menu screen.</p> <p>Usually the menu screen stays on the normal screen or window screen until you press anywhere outside the menu screen or use screen button to close. It then disappears.</p>

3.9.2. Creating and Opening Screens

■ Creating Screens

To create a screen, you can do the following:

- 1) Do one of the following:
 - On the Screen menu, click New Screen...
 - In the Project Manager window, right-click the panel application > Screens item and then click New Screen... on the pop-up menu.
- 2) In the New Screen dialog box, type the name and number desired, and hit the ENTER key or click the OK button to validate your choice. The following is an example of the New Screen dialog box.

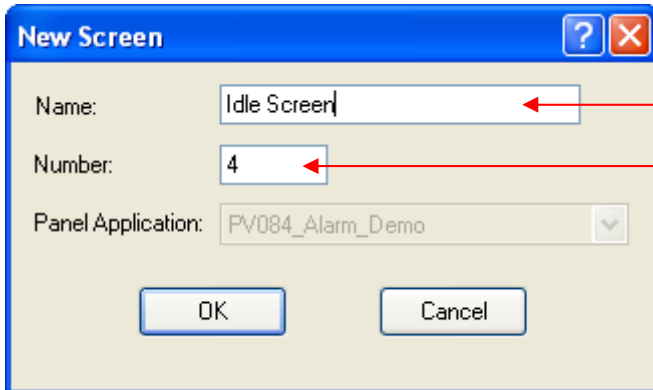

Specify the screen name. Screen names are case insensitive. For example, the names Startup Screen, startup screen are considered to be the same.

Specify the screen number. The screen number must be between 1 and 7999.

Note: In each panel application, both the screen name and the screen number have to be unique.

■ Opening Screens

To open a screen, you can do the following:

- 1) In the Project Manager window, double click the screen you want to open
- 2) On the Screen menu, click Open Screen... In the Open Screen dialog box, select one or multiple screens and click Open button to open all the selected screens.

The following is an example of Open Screen dialog box.

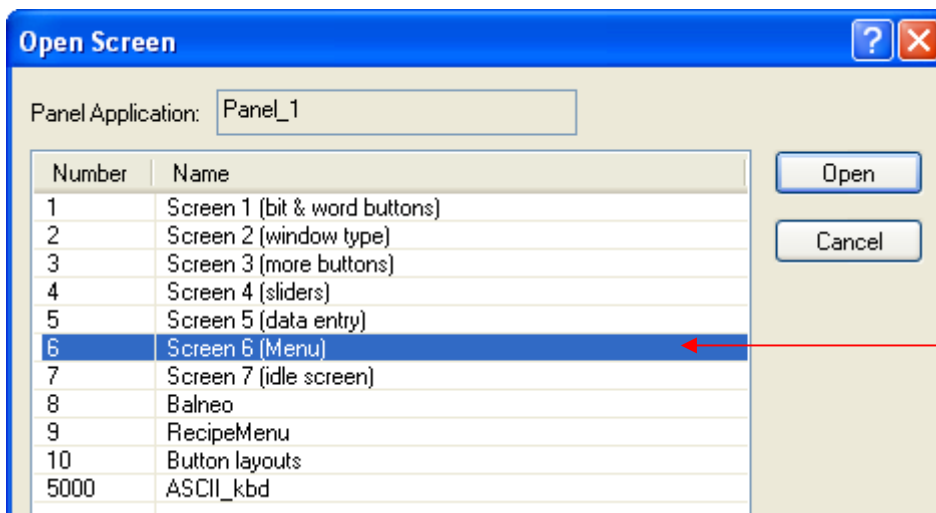

To select a screen, click the row of the screen in the list.

To select multiple screens, click one row and use Ctrl + Click to add additional rows to the selection.

To select continuous screens, click one row and hold the Shift key and click the last row.

■ Activating Screens after Opening

To uncover any screen that is partially or completely obscured by other screens, you can do the following:

- 1) In the Project Manager window, double click the screen which is not at the top.
- 2) On the Window menu, click the screen you need to activate. Or click Windows... to bring out the Windows dialog box. In the Windows dialog box, select the screen and then click Activate button.
- 3) Click anywhere on the screen. If the screens are maximized, click on the title tab of the screen.

3.9.3. Setting up a Screen

You can set up the screen with the Screen Properties dialog box.

To set up a screen, right click Panel Application > Screens > screen to set up in the Project Manager window, and then click Properties on the pop-up menu.

To set up a current screen (an opened screen which is at the top), do one of the following:

- 1) In the Project Manager window, double click the current screen.
- 2) Right click the blank area on the current screen, and then click Screen Properties... on the pop-up menu.
- 3) On the Screen menu, click Screen Properties...

The Screen Properties dialog box contains the following pages. Some of the pages appear only when they are needed.

■ General

Described in [Section 3.9.3.1.](#)

■ Background

Described in [Section 3.9.3.2.](#)

■ Keys

Described in [Section 3.2.2.](#)

■ Open Macro / Close Macro / Cycle Macro

Described in [Section 14.2.6.](#)

3.9.3.1. General Page

This section describes how to define the general settings for a screen. The following is an example of the General page of the Screen Properties dialog box.

Screen Properties

General Background Open Macro Close Macro Cycle Macro

Screen Number: Screen Name:

Use This Screen

Type

Normal Screen Window Screen Menu Screen

Width: Height:

Shown on Display Center
 Shown At

Title Bar Close Button

Language:

Title: **T**

Base Screen

OPEN Macro CLOSE Macro

CYCLE Macro

Cycle Macro Delay Time: milli-second(s)

Print

Whole Screen

Upper-left Corner Lower-right Corner

X1: Y1: X2: Y2:

Position on Paper (millimeters)

X: Y:

Percentage of data scan time allocated to the fast scan: (Note: Use data tags to specify the fast scan)

What to show for an object's content before its corresponding data is scanned for the object?

Blank
 Last scanned data or blank
 Last scanned data or zero

Numeric keypad remains open for continuous data entry



Note:

OK Cancel Help

The following table describes each item in the General page.

Property	Description
Screen Number	The number of the screen. It must be between 1 and 7999.
Screen Name	The name of the screen.
Use This Screen	Check this option to use the screen.
Type	Specifies the type of the screen. There are three types: Normal Screen, Window Screen and Menu Screen. Please see Section 3.9.1 for details.

Continued

Property		Description
Width		Specifies the width (in pixels) of the screen. This field is available to edit when the Type is Window Screen and Menu Screen.
Height		Specifies the height (in pixels) of the screen. This field is available to edit when the Type is Window Screen and Menu Screen.
Shown on Display Center		Check this option to show the window screen on the display center. This field is available when the Type is Window Screen.
Shown At		Check this option to show the window screen at the specified position. This field is available when the Type is Window Screen.
	X	Specifies the X coordinate of the window screen's upper-left corner in pixels on the normal screen.
	Y	Specifies the Y coordinate of the window screen's upper-left corner in pixels on the normal screen.
Title Bar		Select this option to show a title bar with the specified title with the window screen when the Type is Window Screen.
Close Button		Select this option for the window screen to have a close Button when the Type is Window Screen and the Title Bar field is checked.
Language		Select a language to view and edit the settings of the title for that language. This field is available when the Type is Window Screen and Title Bar field is checked.
Title		Specifies the title or select the title from text database for the Title Bar. Click  to select the text from text database. Click  to edit text. This field is available when the Type is Window Screen and Title Bar field is checked.
Base Screen	<Check Box>	Check this option to have a base screen for the current screen
	<Combo Box>	Specifies the screen to be a base screen. This field is available when the Base Screen is checked.
OPEN Macro		Check this item for the screen to have the OPEN macro. An Open Macro is run once when the associated screen is being opened. The target panel will not display the screen until the Open Macro terminates. Use OPEN macro to initialize global data and settings for the screen.
CLOSE Macro		Check this item for the screen to have the CLOSE macro. A Close Macro is run once when the associated screen is being closed. The target panel will not erase the screen until the Close Macro terminates.
CYCLE Macro	<Check Box>	Check this item for the screen to have the CYCLE macro. A Cycle Macro is run continuously while the associated screen is open. The target panel runs Cycle Macros cyclically, i.e. a Cycle Macro will run beginning with the first command each time after it completes the processing of the last command of the macro, or when it encounters an END command in the middle of the macro. The cycle macro terminates immediately when the screen is closed.
	Cycle Macro Delay Time	Specifies the delay time in 0, 100, 200, 300, 400, 500, 600, 700, 800, 900, 1000 millisecond for the cycle macro.
Print	Whole Screen	Check this item to print the whole screen by Command Flag or Function Button or Macro Command
	Upper-left	Specifies the X and Y coordinates in pixels for the upper-left corner of the screen's printing area. The field is available when Whole Screen item is unchecked.
	Lower-Right	Specifies the X and Y coordinates in pixels for the lower-right corner of the screen's printing area. The field is available when Whole Screen item is unchecked.
	Position on Paper	Specifies the X and Y coordinates in millimeters for the position where the specified area of the screen will print on paper.

Continued



Property		Description
Percentage of data scan time allocated to the fast scan		Select the percentage of data scan time allocated to the fast scan among 50%, 66%, 75%, 80%, 86% and 90%. Note: With a bigger percentage, the data scan time is faster to the tag with fast scan rate. However, data scan time is slower to the tag with normal scan rate.
What to show for an object's content before its corresponding data is scanned for the object?	Blank	Select this item to show blank for an object's content before its corresponding data is scanned for the object.
	Last scanned data or blank	Select this item to show last scanned data or blank for an object's content before its corresponding data is scanned for the object.
	Last scanned data or zero	Select this item to show last scanned data or zero for an object's content before its corresponding data is scanned for the object.
Operable under window screen		Check this option to make the screen operable under window screen. This field is available only when the Type is Normal Screen.
Numeric keypad remains open for continuous data entry		Check this option for numeric keypad to remain open for continuous data entry.
Note		Type a note for the screen.

3.9.3.2. Background Page

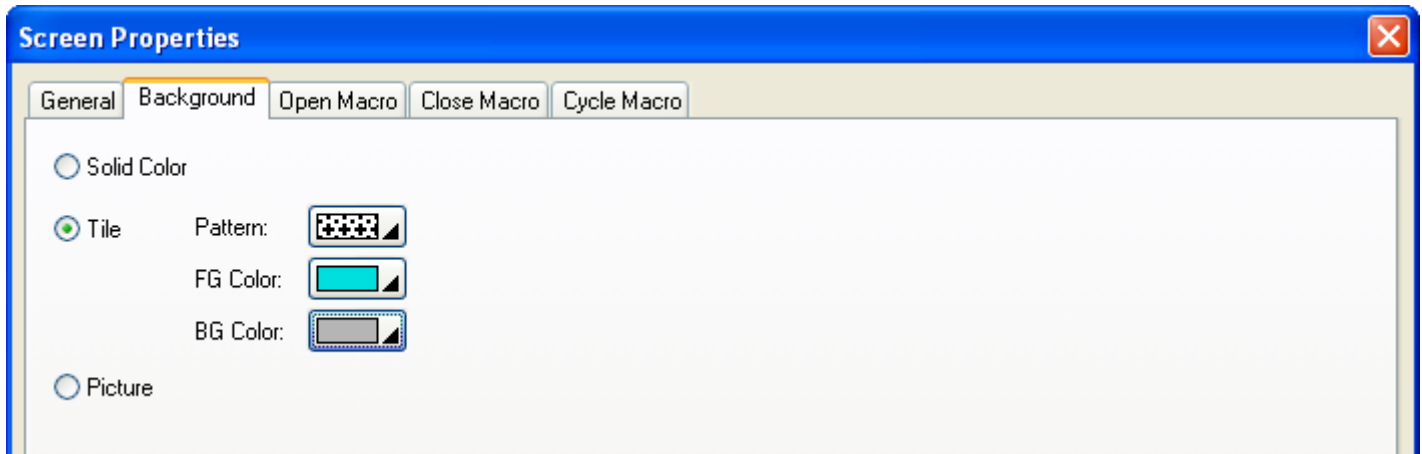
This section describes how to define the background of a screen. The following is an example of the Background page of the Screen Properties dialog box.



The following table describes each item in the Background page.

Property	Description
Solid Color	Check this option for the screen background to be filled with a solid color.
	<Solid Color> Click the corresponding color button to specify the color used to fill the background. This item is available when Solid Color option is selected.
Tile	Check this option for the screen background to be filled with a pattern.
	Pattern Specify the pattern used to fill the background. Click the corresponding Pattern icon and select a pattern from the Pattern palette. This item is available when Tile option is selected.
	FG Color The color used to paint the black part of the pattern. When the solid white pattern is selected, this color is not used. This item is available when Tile option is selected.
	BG Color The color used to paint the white part of the pattern. This item is available when Tile option is selected.
Picture	Check this option to have a picture background for the screen.
	<Name> The name of the picture. Use the drop-down list to select a picture from the picture database. Click  to select a picture file. Then, the picture of the selected file is imported and saved in the picture database. Click  to bring up the Select/Import from Library dialog box. Select a picture from a picture library file. Then, the selected picture is imported and saved in the picture database.
	Stretch Check this item so the picture can change its size automatically to fit the screen.

3.9.4. Importing/Exporting a Screen

This section describes how to export a screen and import a screen regardless of the panel model and screen size.

■ Importing a screen

- 1) Right-click Panel Application > Screens item in the Project Manager window to bring out the pop-up menu and then use Import Screen...
- 2) Click the *.snf file you want to create a new screen from. To open a screen that was saved in a different folder, locate and open the folder first.
- 3) Click Open.

■ Exporting a screen

If you have screen you want to reuse, you can export the screen as a .snf file. You can do the following:

- 1) In the Project Manager window, click the screen to export
- 2) Right-click on the screen to display the screen item's "pop-up menu"; and then click Export Screen...
- 3) To save a screen in a different folder, locate and open the folder first, then click Save.

3.9.5. Cutting/Copying/Pasting/Deleting a Screen

■ Copying or Cutting and Pasting a Screen

To copy/cut a screen which is opened and activated, right click the blank area on the screen, and then click Copy Screen/Cut Screen on the pop-up menu, or use the Copy Screen/Cut Screen command On the Screen menu.

After Copying or Cutting, you can paste the screen by right clicking the blank area on any of the screen, and then use Paste Screen on the pop-up menu or the Paste Screen command On the Screen menu.

■ Deleting a Screen

To delete a screen which is opened and activated, right click the blank area on the screen, and then click Delete Screen on the pop-up menu or use the Delete Screen command on the Screen menu.

To delete a screen from Project Manager window, locate the screen to delete and right-click on the screen node to use the Delete command on the pop-up menu. Confirm the deleting operation.

3.9.6. Saving Screens as Pictures

This section describes how to save screens as pictures.

■ Saving a screen as a picture

To save a current screen as the bmp or jpg file, you can do the following.

- 1) Open and activate the screen as a current screen
 - 2) Right click anywhere on the current screen, and then click Save Current Screen as Picture... on the pop-up menu.
- or -

On the Screen menu, click Save Current Screen as Picture...

■ Saving multiple screens as pictures

You can also use the Save Screens as Pictures dialog box to save a screen or multiple screens as bmp or jpg files. To open the dialog box, click Save Screens as Pictures... on the Screen menu.

The following is an example of the Save Screens as Pictures dialog box.

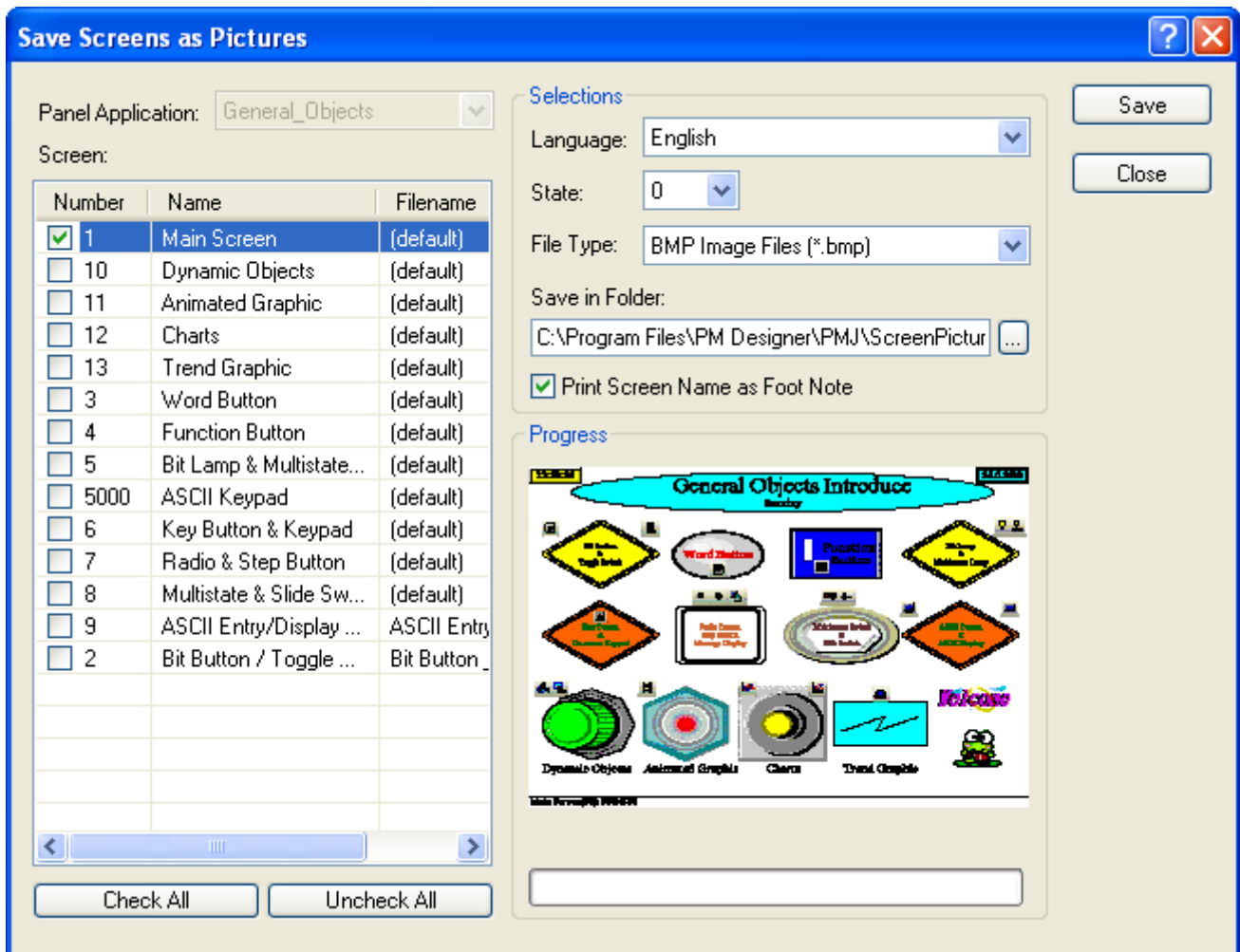

The following table describes each item in the dialog box.

Property		Description								
Panel Application		The application Name.								
Screen		<p>The screen list shows all the screens in the panel application. Click the column header to sort the items.</p> <p>The following table describes each column in the screen list.</p> <table border="1"> <thead> <tr> <th>Column</th> <th>Description</th> </tr> </thead> <tbody> <tr> <td>Number</td> <td>The screen number. Check the box before the screen number to save the screen as a picture file.</td> </tr> <tr> <td>Name</td> <td>The screen name.</td> </tr> <tr> <td>Filename</td> <td>The Filename. The default filename is Screen Name+Language Name+S+State Number. Note: If any of the characters such as \:*\?"<> in the screen name, they will be converted to underscore (_).</td> </tr> </tbody> </table>	Column	Description	Number	The screen number. Check the box before the screen number to save the screen as a picture file.	Name	The screen name.	Filename	The Filename. The default filename is Screen Name+Language Name+S+State Number. Note: If any of the characters such as \:*\?"<> in the screen name, they will be converted to underscore (_).
Column	Description									
Number	The screen number. Check the box before the screen number to save the screen as a picture file.									
Name	The screen name.									
Filename	The Filename. The default filename is Screen Name+Language Name+S+State Number. Note: If any of the characters such as \:*\?"<> in the screen name, they will be converted to underscore (_).									
Check All		Click the button to check all the screens.								
Uncheck All		Click the button to uncheck all the screens.								
Selections	Language	The language used to display the text of objects.								
	State	The state that displays the state of objects.								
	File Type	Select the file type. There are two types: bmp and jpg.								
	Save in Folder	Specifies the folder to locate the files. If the file exists in the folder, it will be replaced by the new one.								
	Print Screen Name as Foot Note	Check this option to display general screen information, such as foot note. The format of the foot note is Screen Name (#Screen Number); Screen WidthXScreen Height.								
Progress	<Screen View>	Show the selected screen or the screen which is being saved. To select a screen, click its row in the screen list.								
	<Progress Bar>	Show the saving progress after the Save button is clicked.								
Save		Click the button to save all the selections with the specified conditions.								
Close		Click the button to exit the dialog box.								

CHAPTER 4

DESIGNING SCREENS

4.1. Drawing Basic Shapes	1
4.1.1. Drawing Dots	2
4.1.2. Drawing Lines	3
4.1.3. Drawing Polylines	5
4.1.4. Drawing Rectangles	8
4.1.5. Drawing Circles	11
4.1.6. Drawing Ellipses	13
4.1.7. Drawing Arcs	15
4.1.8. Drawing Pie Shapes	16
4.1.9. Drawing Polygons	18
4.1.10. Drawing Text Objects	21
4.1.11. Drawing Picture Objects	24
4.1.12. Drawing Scales	26
4.1.13. Drawing Tables	28
4.2. Editing Objects	32
4.2.1. Selecting and De-selecting Objects	32
4.2.2. Basic Operations with the Selected Area	32
4.2.3. Duplicating Objects	34
4.2.4. Aligning Objects	35
4.2.5. Making Objects Same Size	36
4.2.6. Arranging the Order of Objects	36
4.3. Designing Object Appearance	38
4.3.1. Selecting a Color	40
4.3.2. Selecting a Pattern	41
4.3.3. Selecting a Graphical Shape	41
4.3.4. Setting up the Shape of an Object	44
4.3.5. Label Settings	45
4.3.6. Text Settings	49
4.3.7. Picture Settings	51
4.3.8. External Label Settings	53

4.4.	Setting up Objects	55
4.4.1.	States of Objects	55
4.4.2.	Operation Options of Objects	57
4.4.3.	Address Settings	58
4.4.4.	Scale Settings.....	61
4.4.5.	Advanced Settings	63
4.4.6.	Visibility Settings.....	65

4.1. Drawing Basic Shapes

The software provides a drawing tool you can use to create simple or elaborate drawing shapes such as lines, rectangles, circles, arcs etc.

To create a drawing shape, click the shape on the Draw Toolbar (See [Section 1.4.2.3 Draw Toolbar](#) for details), or use the command on the Draw menu (See [Section 1.4.1.5 Draw menu](#) for details). Then, move the mouse to the position you want to place the shape and click the left button. To set up a drawing shape, double-click the shape to bring up the corresponding properties dialog, which can then allow you to set up the color and style of the line/outlined, pattern, FG/BG Color...of the shape.

Note: If you don't see the Draw Toolbar pictured below in the lower left corner of the program window, please click the Draw Toolbar command on the View menu.



The following is a sample of the basic shapes:

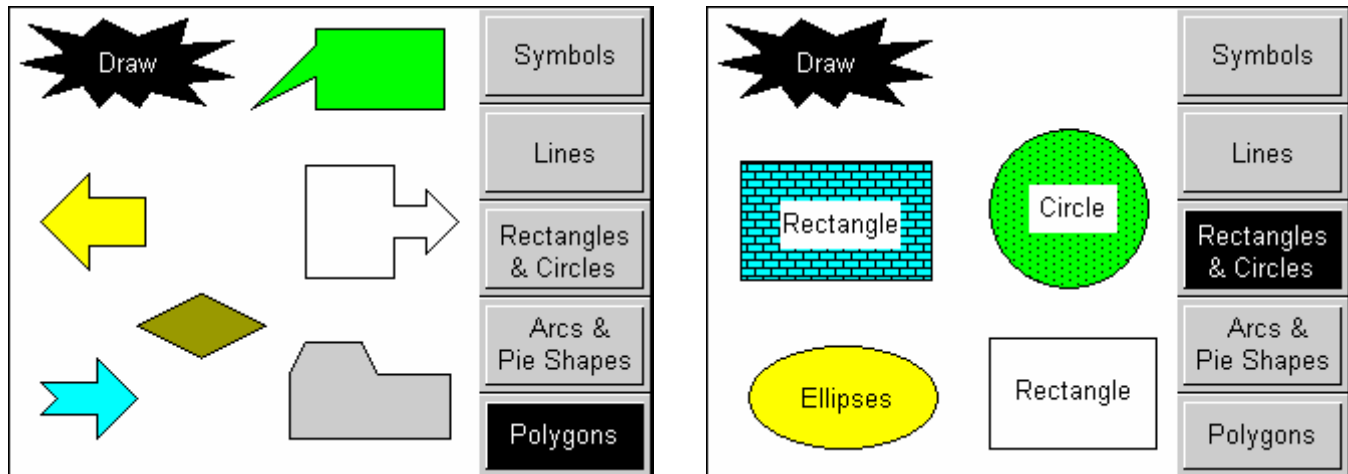

4.1.1. Drawing Dots

1. In the Draw menu or Draw toolbar, click **Dot** .
2. Move the cursor onto the screen where you want to draw a dot. A dot with default settings will display and move along with the cursor.
3. Click the desired position on the screen to place the dot. The center of the dot will be at the clicked position.
4. Double-click the dot to bring up the Dot dialog box and then modify the settings of the dot.

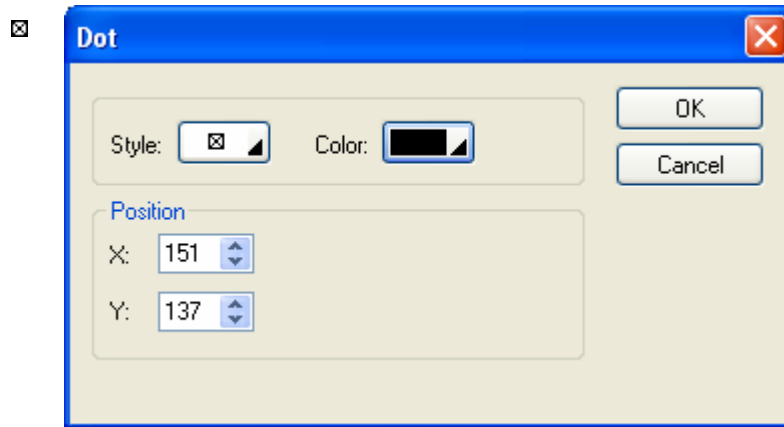

The following is an example of the Dot dialog box.



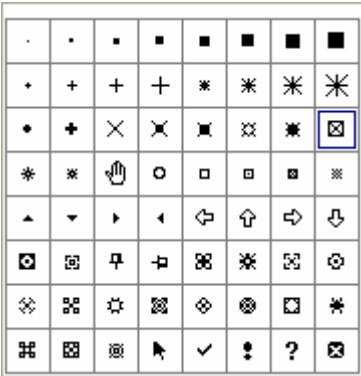

The following table describes each property in the Dot dialog box.

Property		Description
Style		Select one of the dot styles listed below: 
Color		Specifies the dot color.
Position	X	Specifies the X coordinate of the upper-left corner of the dot.
	Y	Specifies the Y coordinate of the upper-left corner of the dot.

5. You can click the following icons in the Draw toolbar to modify the properties of the dot.

Click Icon	To
	Select a style for the dot.
	Select a color for the dot.

4.1.2. Drawing Lines

1. In the Draw menu or Draw toolbar, click Line  to draw a straight line. You can also click **Horizontal Line**  to draw a horizontal line or click **Vertical Line**  to draw a vertical line.
2. Move the cursor onto the screen where you want to draw a line. A line with default settings will display and move along with the cursor.
3. Click the desired position on the screen to place the line. The start point of the line will be at the clicked position.
4. Drag the handle at the start point to adjust the position of the start point. Drag the handle at the end point to adjust the position of the end point.

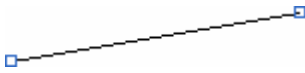

The picture on the left shows the two handles of a line. Position the mouse pointer over one of the handles. When the cursor changes to , drag the handle until the line has the length and slope you want.

5. Left-click and hold down the mouse button until the cursor becomes a cross icon  to move the line.
6. Double-click the line to bring up the Line dialog box and then modify the settings of the line. The following is a sample of the Line dialog box.

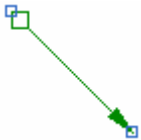



Line

Type: General Horizontal Vertical Style: 

Color: Static Blink Controlled By Bit Blink (Enabled by Bit)

State: Color: 



Start Point End Point

Type:  Type: 

Filled Filled

Size: 1 Size: 1

Visibility Controlled By Bit





Control Bit: \$U1.0  

Visible State: ON OFF

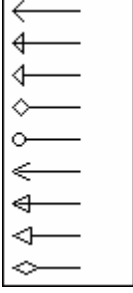
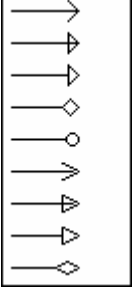

Terminal: X1: 28 X2: 88 Y1: 6 Y2: 66

OK Cancel

The following table describes each property in the Line dialog box.

Property		Description
Type		Specifies the type of line: General, Horizontal, or Vertical.
Style		Click the button to select the line style from the dropdown window shown on the right: 
Color	Static	Check this option if the color of the line will not be changed.
	Controlled By Bit	Check this option if the color of the line will be controlled by the specified bit.
	Blink	Check this option so the line will blink. You have to choose the blink effects that change the color of the line from its On state color to Off state color.
	Blink(Enabled by Bit)	Check this option if you want to enable the line blinking by the specified bit.
	State	Select the state that you want to view or define the color for.
	Color	Specifies the line color for the selected state.
	Control Bit	Specifies the bit that controls the color or enables the color blinking. Click  to enter the bit address. Click  to enter the bit tag.
Start / End Point	Start/End Point	Select this option if you want the line to have a shape at the start/end point.
	Type	Click the dropdown list to select the type for Start/End Point Start Point Type:  End Point Type: 
	Filled	Select this option if you want the shape to be filled with the line color.
	Size	Specifies the shape size.
Visibility Control	Visibility Controlled By Bit	Check this option if the line will be shown or hidden by the specified bit.
	Control Bit	Specifies the bit that shows or hides the object. Click  to enter the bit address. Click  to enter the bit tag.
	Visible State	Specifies the state (On or Off) that makes the line visible.
Terminal	X1	The X coordinate of the start point.
	Y1	The Y coordinate of the start point.
	X2	The X coordinate of the end point.
	Y2	The Y coordinate of the end point.





7. You can click the following icons in the Draw toolbar to modify the properties of the line.

Click Icon	To
	Select a style for the line.
	Select a color for the line.

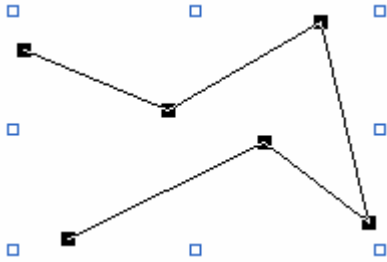
4.1.3. Drawing Polylines

1. In the Draw menu or Draw toolbar, click **Polyline**  to draw a polyline.
2. Move the cursor onto the screen where you want to draw a polyline, and click the position where you want the start point of the polyline to be at.
3. Continue clicking on the screen to place as many points needed for nodes in the polyline.
4. Right-click to place the last point for the polyline and complete the polyline.
5. Drag one blue handle of the polyline at a time to resize the polyline.
6. Drag one black handle of the polyline at a time to adjust the node positions of the polyline.



The picture on the left shows all the blue and black handles of a polyline. Position the mouse pointer over one of the handles. When the cursor changes to  or  or  or , drag the handle until the polyline is the shape and size you want.

7. Right-click anywhere on the polyline and use the Insert Point command on the object pop-up menu to insert a new point for the polyline. Or right-click the existing point of the polyline and use the Delete Point command on the object pop-up menu to delete the point.

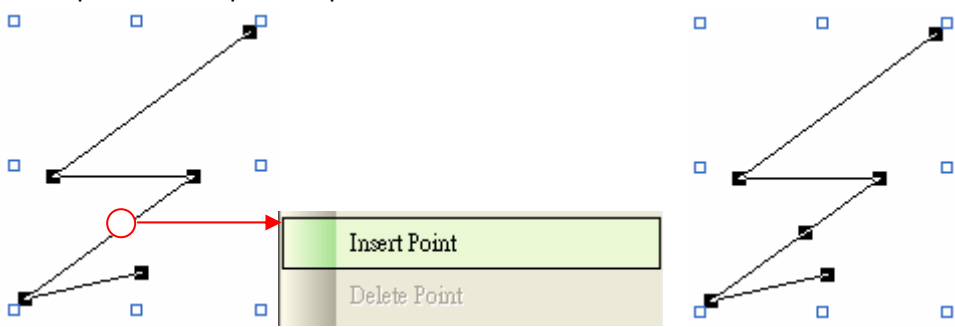
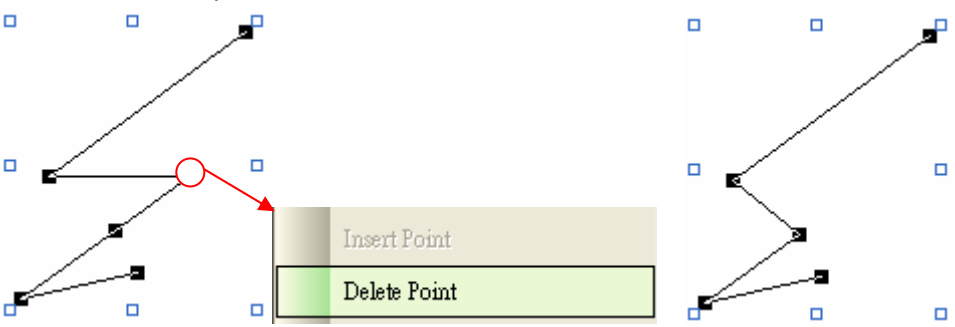

Pop-up menu	Description
Insert Point	<p>Add a point at the specified position.</p> 
Delete Point	<p>Delete a selected point.</p> 

8. Double-click the polyline to bring up the Polyline dialog box and then modify the settings of the polyline.

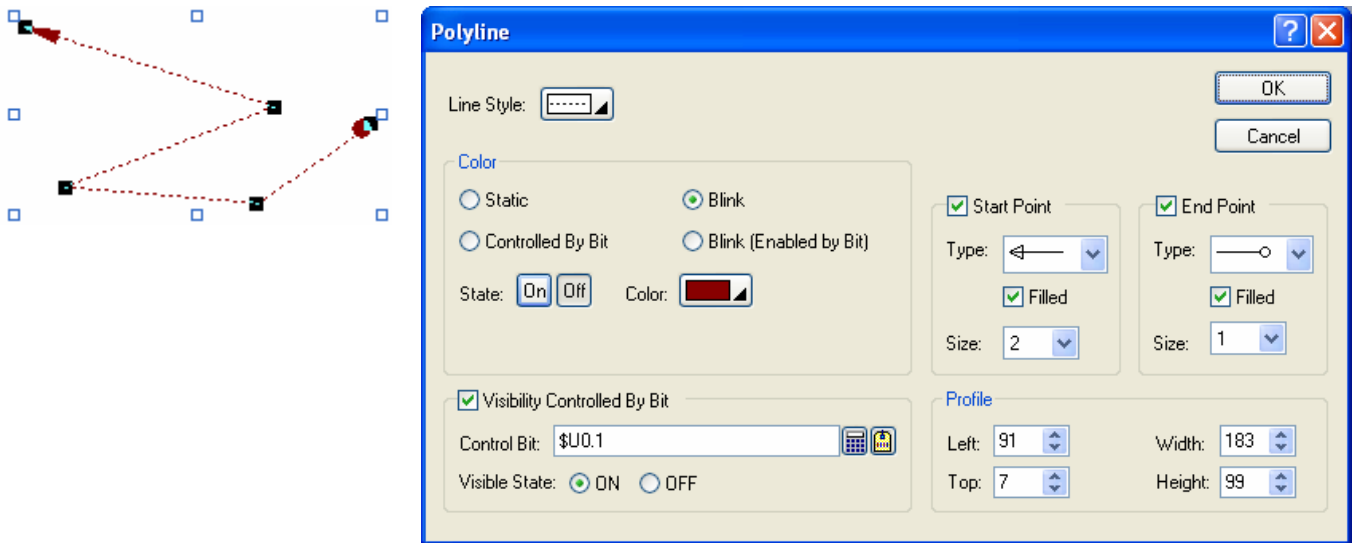

The following is a sample of the Polyline dialog box.





The following table describes each property in the Polyline dialog box.

Property		Description
Line Style		Specifies the style of the polyline.
Color	Static	Check this option if the color of the polyline will not be changed.
	Controlled By Bit	Check this option if the color of the polyline will be controlled by the specified bit.
	Blink	Check this option so the polyline will blink. You have to choose the blink effects that change the color of the polyline from its On state color to Off state color.
	Blink(Enabled by Bit)	Check this option if you want to enable the polyline blinking by the specified bit.
	State	Select the state that you want to view or define the color for.
	Color	Specifies the line color for the selected state.
	Control Bit	Specifies the bit that controls the color or enables the color blinking. Click  to enter the bit address. Click  to enter the bit tag.
Start Point	Start Point	Select this option if you want the polyline to have a shape at the start point.
	Type	Specifies the shape type.
	Filled	Select this option if you want the shape to be filled with the line color.
	Size	Specifies the shape size.
End Point	End Point	Select this option if you want the polyline to have a shape at the end point.
	Type	Specifies the shape type.
	Filled	Select this option if you want the shape to be filled with the line color.
	Size	Specifies the shape size.



Continued

Property		Description
Visibility Control	Visibility Controlled By Bit	Check this option if the polyline will be shown or hidden by the specified bit.
	Control Bit	Specifies the bit that shows or hides the polyline. Click  to enter the bit address. Click  to enter the bit tag.
	Visible State	Specifies the state (On or Off) that makes the line visible.
Profile	Left	The X coordinate of the upper-left corner of the bounding rectangle of the polyline.
	Top	The Y coordinate of the upper-left corner of the bounding rectangle of the polyline.
	Width	The width of the bounding rectangle of the polyline.
	Height	The height of the bounding rectangle of the polyline.





9. You can click the following icons in the Draw toolbar to modify the properties of the polyline.

Click Icon	To
	Select a style for the polyline.
	Select a color for the polyline.

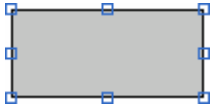
4.1.4. Drawing Rectangles

1. In the Draw menu or Draw toolbar, click **Rectangle**  to draw a normal rectangle. You can also click **Round Rectangle**  to draw a round rectangle or click **Clipped Rectangle**  to draw a clipped rectangle.
2. Move the cursor onto the screen where you want to draw a rectangle. A rectangle with default settings will display and move along with the cursor.
3. Click the desired position on the screen to place the rectangle. The upper-left corner of the rectangle will be at the clicked position.
4. Drag one handle of the rectangle at a time to resize the rectangle.



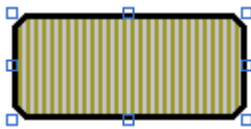

The picture on the left shows the eight handles of a rectangle. Position the mouse pointer over one of the handles. When the cursor changes to  or  or  or , drag the handle until the rectangle is the shape and size you want.

5. Double-click the rectangle to bring up the Rectangle dialog box and then modify the settings of the rectangle. The following is a sample of the Rectangle dialog box.





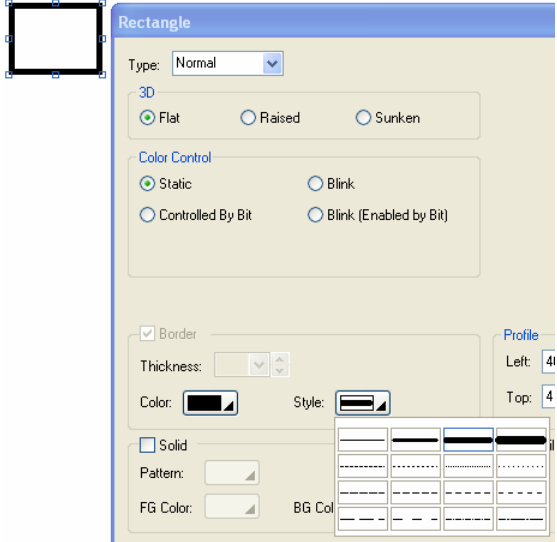
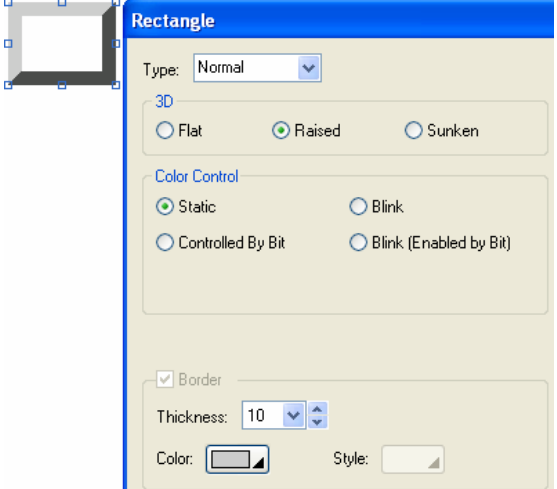
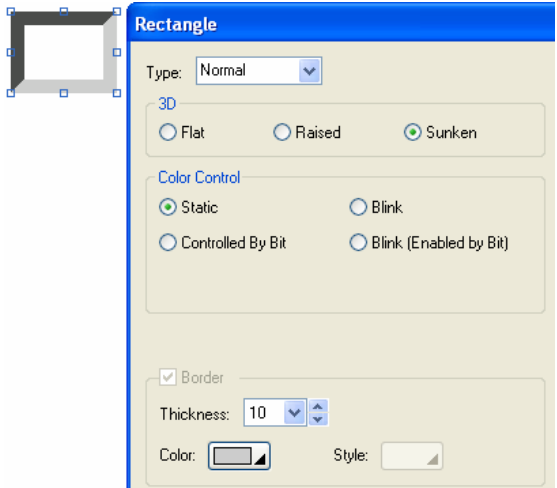

The following table describes each property in the Rectangle dialog box.

Property	Description		
Type	Specifies the type of the rectangle. There are three types: Normal, Round, or Clipped.		
	Normal	Round	Clipped
			





Continued

Property	Description		
Number of Dots	Specifies the size of the clipped corners if the rectangle is a clipped rectangle. Specifies the radius of the round corners if the rectangle is a round rectangle.		
3D	Specifies the 3D visual effect for the rectangle. There are three effects: Flat, Raised, or Sunken.		
	Effects	Samples	Description
	Flat		<p>You can specify the Color and Style for the Border if it is selected.</p> <p>Thickness field is not available when flat is selected.</p>
	Raised		<p>You can specify the color for the top and left edges. The software will darken the specified color and draw in the bottom and right edges for you.</p> <p>Border and Style field is not available when Raised is selected.</p>
Sunken		<p>You can specify the color for the bottom and right edges. The software will darken the specified color and draw in the top and left edges for you.</p> <p>Border and Style field is not available when Sunken is selected.</p>	





Continued

Property		Description
Color Control	Static	Check this option if the color of the rectangle will not be changed.
	Controlled By Bit	Check this option if the color of the rectangle will be controlled by the specified bit.
	Blink	Check this option so the rectangle will blink. You have to choose the blink effects that change the color of the rectangle from its On state Border and Solid option settings to Off state Border and Solid option settings.
	Blink(Enabled by Bit)	Check this option if you want to enable the rectangle blinking by the specified bit.
	Control Bit	Specifies the bit that controls the color or enables the blinking. Click  to enter the bit address. Click  to enter the bit tag.
State		Select the state that you want to view or define the colors for.
Border	Border	Check this option if you want the rectangle to have a border.
	Thickness	Specifies the thickness of the border.
	Color	Specifies the border color for the selected state.
	Style	Select a line style for the border.
Solid	Solid	Check this option if you want the rectangle to be solid. A solid rectangle is filled with the specified pattern and colors. This field is available when Border is selected.
	Pattern	Specifies the fill pattern for the selected state.
	FG Color	Specifies the color for the selected state that will be used for painting the black part of the fill pattern.
	BG Color	Specifies the color for the selected state that will be used for painting the white part of the fill pattern.
Profile	Left	The X coordinate of the upper-left corner of the rectangle.
	Top	The Y coordinate of the upper-left corner of the rectangle.
	Width	The width of the rectangle.
	Height	The height of the rectangle.
Visibility Control	Visibility Controlled By Bit	Check this option if the rectangle will be shown or hidden by the specified bit.
	Control Bit	Specifies the bit that shows or hides the rectangle. Click  to enter the bit address. Click  to enter the bit tag.
	Visible State	Specifies the state (On or Off) that makes the rectangle visible.

6. You can click the following icons in the Draw toolbar to modify the properties of the rectangle.

Click Icon	To
	Select a line style for the border.
	Select a color for the border.
	Select a color for painting the white part of the fill pattern.
	Select a pattern for the fill pattern.
	Select a color for painting the black part of the fill pattern.

4.1.5. Drawing Circles

1. In the Draw menu or Draw toolbar, click **Circle**  to draw a circle.
2. Move the cursor onto the screen where you want to draw a circle. A circle with default settings will display and move along with the cursor.
3. Click the desired position on the screen to place the circle. The center of the circle will be at the clicked position.
4. Position the mouse pointer over the handle on the edge of the circle. When the cursor changes to  or , drag the handle until the circle is the size you want.
5. Position the mouse pointer over the handle on the center of the circle. When the cursor changes to , left-click the center and hold down the button to move the circle.

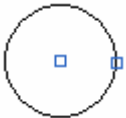

The picture on the left shows the two handles of a circle.

6. Double-click the circle to bring up the Circle dialog box to modify the settings of the circle.

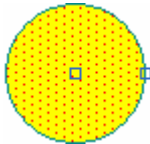

The following is a sample of the Circle dialog box.



?
X

Color Control

Static Blink
 Controlled By Bit Blink (Enabled by Bit)

Control Bit:  

State:

Outlined

Color:

Solid

Pattern:



FG Color: BG Color:

Center & Radius

X: Radius:





Y:

Visibility Controlled By Bit





Control Bit:  

Visible State: ON OFF

The following table describes each property in the Circle dialog box.

Property		Description
Color Control	Static	Check this option if the color of the circle will not be changed.
	Controlled By Bit	Check this option if the color of the circle will be controlled by the specified bit.
	Blink	Check this option so the circle will blink. You have to choose the blink effects that change the color of the circle from its On state Outlined and Solid option settings to Off state Outlined and Solid option settings.
	Blink(Enabled by Bit)	Check this option if you want to enable the rectangle blinking by the specified bit.
	Control Bit	Specifies the bit that controls the color or enables the blinking. Click  to enter the bit address. Click  to enter the bit tag.
State		Select the state that you want to view or define the colors for.
Outline	Outlined	Check this option if you want the circle to be outlined.
	Color	Specifies the outline color for the selected state.
Solid	Solid	Check this option if you want the circle to be solid. A solid circle is filled with the specified pattern and colors.
	Pattern	Specifies the fill pattern for the selected state.
	FG Color	Specifies the color for the selected state that will be used for painting the black part of the fill pattern.
	BG Color	Specifies the color for the selected state that will be used for painting the white part of the fill pattern.
Center & Radius	X	The X coordinate of the center of the circle.
	Y	The Y coordinate of the center of the circle.
	Radius	The radius of the circle.
Visibility Control	Visibility Controlled By Bit	Check this option if the circle will be shown or hidden by the specified bit.
	Control Bit	Specifies the bit that shows or hides the circle. Click  to enter the bit address. Click  to enter the bit tag.
	Visible State	Specifies the state (On or Off) that makes the circle visible.





7. You can click the following icons in the Draw toolbar to modify the properties of the circle.

Click Icon	To
	Select a color for the outline.
	Select a color for painting the white part of the fill pattern.
	Select a pattern for the fill pattern.
	Select a color for painting the black part of the fill pattern.

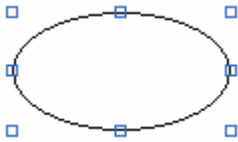
4.1.6. Drawing Ellipses

1. In the Draw menu or Draw toolbar, click **Ellipse**  to draw an ellipse.
2. Move the cursor onto the screen where you want to draw an ellipse. An ellipse with default settings will display and move along with the cursor.
3. Click the desired position on the screen to place the ellipse. The upper-left corner of the bounding rectangle of the ellipse will be at the clicked position.
4. Drag one handle of the ellipse at a time to resize the ellipse.



The picture on the left shows the eight handles of an ellipse. Position the mouse pointer over one of the handles. When the cursor changes to  or  or  or , drag the handle until the rectangle is the shape and size you want.

5. Double-click the ellipse to bring up the Ellipse dialog box and then modify the settings of the ellipse.

The following is a sample of the Ellipse dialog box.

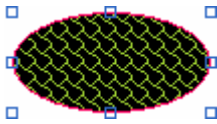

Ellipse
? X

Color Control

Static
 Controlled By Bit

Blink
 Blink (Enabled by Bit)

Control Bit:
[Calculator] [Help]

State:

Outlined

Color:

Solid

Pattern:

FG Color:

BG Color:

Profile

Left:

Width:

Top:





Height:

Visibility Controlled By Bit





Control Bit:
[Calculator] [Help]

Visible State: ON OFF

The following table describes each property in the Ellipse dialog box.

Property		Description
Color Control	Static	Check this option if the color of the ellipse will not be changed.
	Controlled By Bit	Check this option if the color of the ellipse will be controlled by the specified bit.
	Blink	Check this option so the ellipse will blink. You have to choose the blink effects that change the color of the ellipse from its On state Outlined and Solid option settings to Off state Outlined and Solid option settings.
	Blink(Enabled by Bit)	Check this option if you want to enable the ellipse blinking by the specified bit.
	Control Bit	Specifies the bit that controls the color or enables the blinking. Click  to enter the bit address. Click  to enter the bit tag.
State		Select the state that you want to view or define the colors for.
Outline	Outlined	Check this option if you want the ellipse to be outlined.
	Color	Specifies the outline color for the selected state.
Solid	Solid	Check this option if you want the ellipse to be solid. A solid ellipse is filled with the specified pattern and colors.
	Pattern	Specifies the fill pattern for the selected state.
	FG Color	Specifies the color for the selected state that will be used for painting the black part of the fill pattern.
	BG Color	Specifies the color for the selected state that will be used for painting the white part of the fill pattern.
Profile	Left	The X coordinate of the upper-left corner of the bounding rectangle of the ellipse.
	Top	The Y coordinate of the upper-left corner of the bounding rectangle of the ellipse.
	Width	The width of the bounding rectangle of the ellipse.
	Height	The height of the bounding rectangle of the ellipse.
Visibility Control	Visibility Controlled By Bit	Check this option if the ellipse will be shown or hidden by the specified bit.
	Control Bit	Specifies the bit that shows or hides the ellipse. Click  to enter the bit address. Click  to enter the bit tag.
	Visible State	Specifies the state (On or Off) that makes the ellipse visible.

6. You can click the following icons in the Draw toolbar to modify the properties of the ellipse.



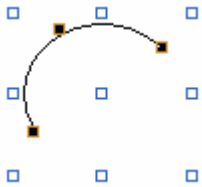

Click Icon	To
	Select a color for the outline.
	Select a color for painting the white part of the fill pattern.
	Select a pattern for the fill pattern.
	Select a color for painting the black part of the fill pattern.

4.1.7. Drawing Arcs

1. In the Draw menu or Draw toolbar, click **Arc**  to draw an arc.
2. Move the cursor onto the screen where you want to draw an arc. An arc with default settings will display and move along with the cursor.
3. Click the desired position on the screen to place the arc. The upper-left corner of the bounding rectangle of the arc will be at the clicked position.
4. Drag one handle of the arc at a time to change the shape of the arc.



The picture on the left shows the handles of an arc. The blue handles are for shaping the arc. The black handles of the two ends of the arc are for changing the ends' angles. The black handle at the center of the arc is for forcing the arc to be a part of a circle.

Position the mouse pointer over one of the handles. When the cursor changes to  or  or  or , drag the handle until the arc is the shape and size you want.

5. Double-click the arc to bring up the Arc dialog box and then modify the settings of the arc.

The following is a sample of the Arc dialog box.

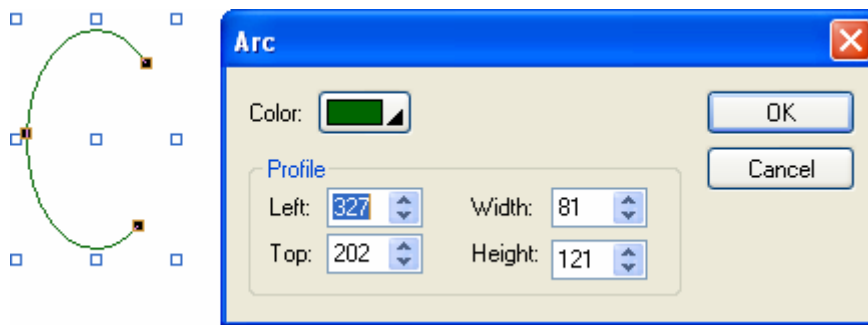

The following table describes each property in the Arc dialog box.

Property	Description	
Color	Specifies the color of the arc.	
Profile	Left	The X coordinate of the upper-left corner of the bounding rectangle of the arc.
	Top	The Y coordinate of the upper-left corner of the bounding rectangle of the arc.
	Width	The width of the bounding rectangle of the arc.
	Height	The height of the bounding rectangle of the arc.

6. You can click the following icons in the Draw toolbar to modify the properties of the arc.



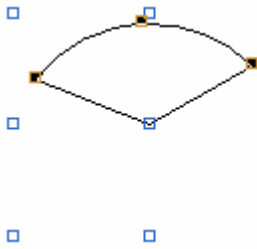

Click Icon	To
	Select a color for the arc.

4.1.8. Drawing Pie Shapes

1. In the Draw menu or Draw toolbar, click **Pie**  to draw a pie shape.
2. Move the cursor onto the screen where you want to draw a pie shape. A pie shape with default settings will display and move along with the cursor.
3. Click the desired position on the screen to place the pie shape. The upper-left corner of the bounding rectangle of the pie shape will be at the clicked position.
4. Drag one handle of the pie shape at a time to change the pie shape.



The picture on the left shows the handles of a pie shape. The blue handles are for changing the pie shape. The black handles at the two ends of the pie are for changing the size of the pie. Clicking the black handle at the center of the pie applies the radius to the entire pie and can be used to change the radius of the pie.

Position the mouse pointer over one of the handles. When the cursor changes to  or  or  or , drag the handle until the pie is the shape and size you



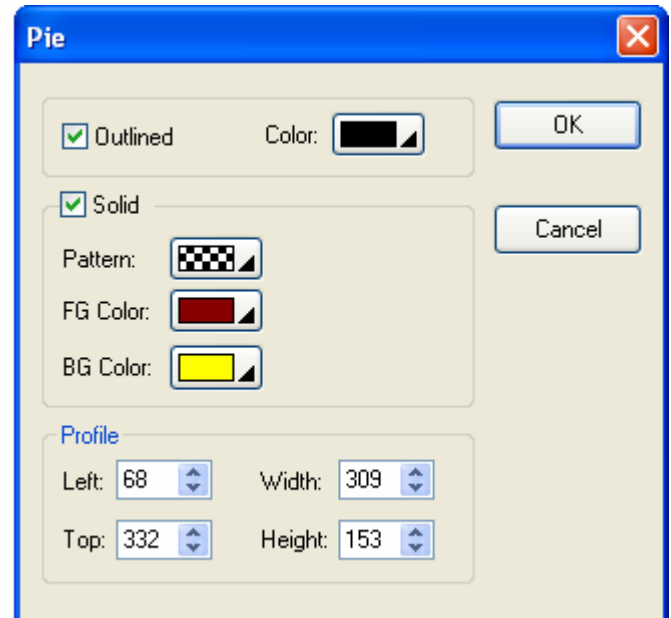
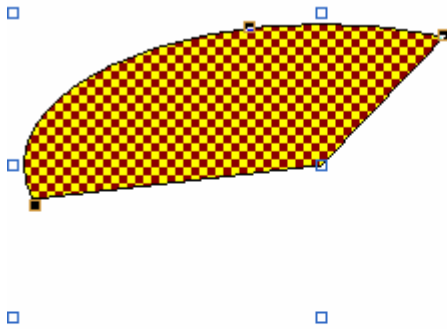

5. Double-click the pie shape to bring up the Pie dialog box to modify the settings of the pie shape.



The following table describes each property in the Pie dialog box.

Property		Description
Outline	Outlined	Check this option if you want the pie shape to be outlined.
	Color	Specifies the outline color.
Solid	Solid	Check this option if you want the pie shape to be solid. A solid pie shape is filled with the specified pattern and colors.
	Pattern	Specifies the fill pattern.
	FG Color	Specifies the color that will be used for painting the black part of the fill pattern.
	BG Color	Specifies the color that will be used for painting the white part of the fill pattern.
Profile	Left	The X coordinate of the upper-left corner of the bounding rectangle of the pie shape.
	Top	The Y coordinate of the upper-left corner of the bounding rectangle of the pie shape.
	Width	The width of the bounding rectangle of the pie shape.
	Height	The height of the bounding rectangle of the pie shape.

6. You can click the following icons in the Draw toolbar to modify the properties of the pie shape



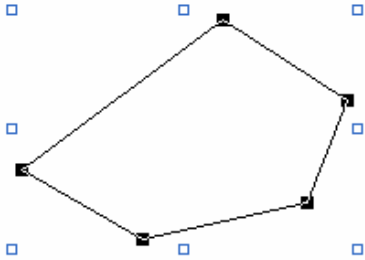

Click Icon	To
	Select a color for the outline.
	Select a color for painting the white part of the fill pattern.
	Select a pattern for the fill pattern.
	Select a color for painting the black part of the fill pattern.

4.1.9. Drawing Polygons

1. In the Draw menu or Draw toolbar, click **Polygon**  to draw a polygon.
2. Move the cursor onto the screen where you want to draw a polygon and click the position where you want the first vertex of the polygon to be at.
3. Continue clicking on the screen to place as many points needed for vertices in the polygon.
4. Right-click to place the last vertex for the polygon and complete the polygon.
5. Drag one handle of the polygon at a time to resize the polygon.
6. Drag one black handle of the polygon at a time to adjust the vertex positions of the polygon.



The picture on the left shows the handles of a polygon. The blue handles are for resizing the polygon. The black handles are for moving the vertices of the polygon.

Position the mouse pointer over one of the handles. When the cursor changes to  or  or  or , drag the handle until the polygon is the shape and size you want.

7. Right-click anywhere on the polygon and use the Insert Point command on the object pop-up menu to insert a new point for the polygon. Or right-click the existing point of the polygon and use the Delete Point command on the object pop-up menu to delete the point.

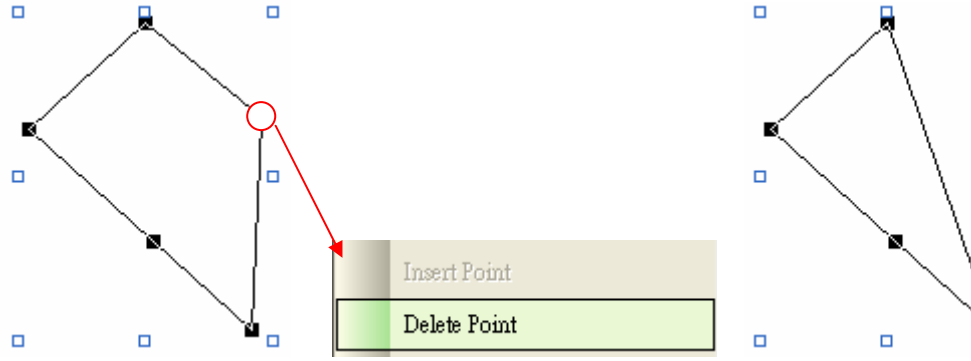
Pop-up menu	Description
Insert Point	<p>Add a point at the specified position.</p> 
Delete Point	<p>Delete a selected point.</p> 

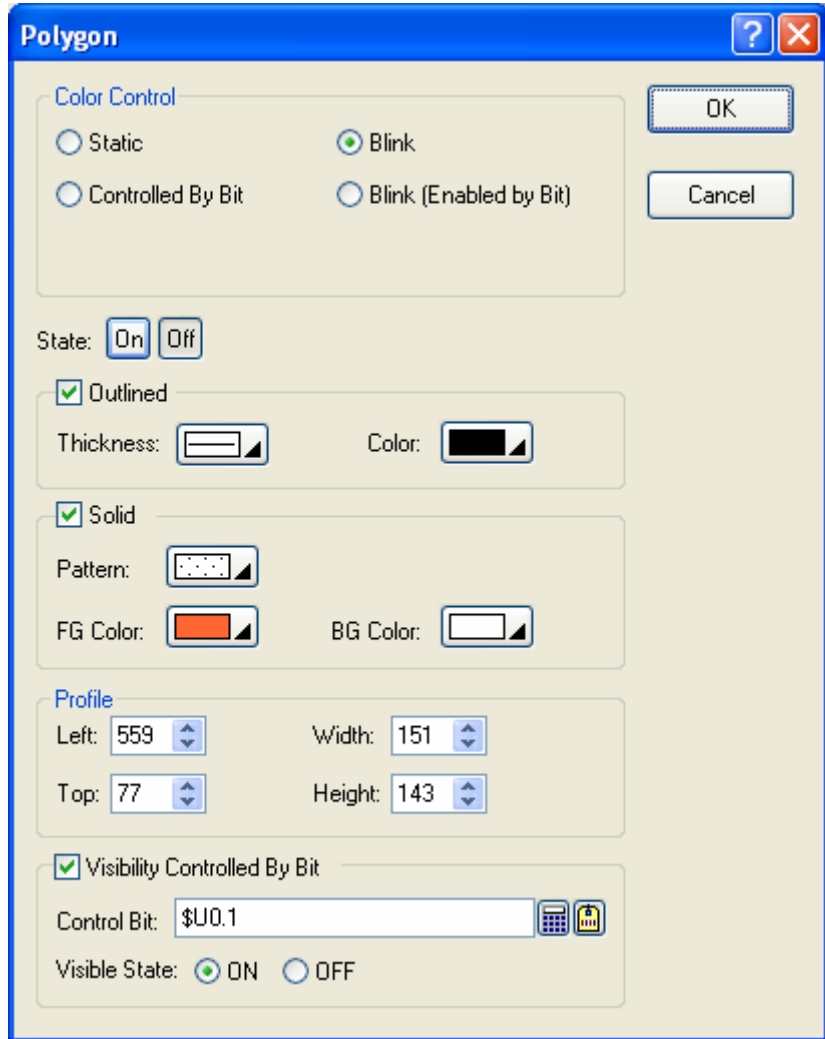
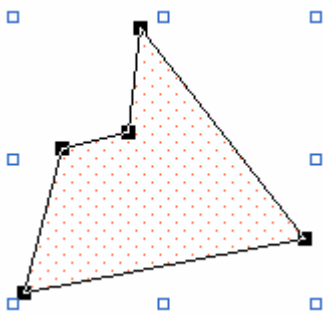

8. Double-click the polygon to bring up the Polygon dialog box to modify the settings of the polygon.







The following table describes each property in the Polygon dialog box.

Property		Description
Color Control	Static	Check this option if the color of the polygon will not be changed.
	Controlled By Bit	Check this option if the color of the polygon will be controlled by the specified bit.
	Blink	Check this option so the polygon will blink. You have to choose the blink effects that change the color of the polygon from its On state Outlined and Solid option settings to Off state Outlined and Solid option settings.
	Blink(Enabled by Bit)	Check this option if you want to enable the polygon blinking by the specified bit.
	Control Bit	Specifies the bit that controls the color or enables the blinking. Click to enter the bit address. Click to enter the bit tag.
State		Select the state that you want to view or define the colors for.
Outline	Outlined	Check this option if you want the polygon to be outlined.
	Thickness	Specifies the thickness of the outline.
	Color	Specifies the outline color for the selected state.

Continued

Property		Description
Solid	Solid	Check this option if you want the polygon to be solid. A solid polygon is filled with the specified pattern and colors.
	Pattern	Specifies the fill pattern for the selected state.
	FG Color	Specifies the color for the selected state that will be used for painting the black part of the fill pattern.
	BG Color	Specifies the color for the selected state that will be used for painting the white part of the fill pattern.
Profile	Left	The X coordinate of the upper-left corner of the bounding rectangle of the polygon.
	Top	The Y coordinate of the upper-left corner of the bounding rectangle of the polygon.
	Width	The width of the bounding rectangle of the polygon.
	Height	The height of the bounding rectangle of the polygon.
Visibility Control	Visibility Controlled By Bit	Check this option if the polygon will be shown or hidden by the specified bit.
	Control Bit	Specifies the bit that shows or hides the polygon. Click  to enter the bit address. Click  to enter the bit tag.
	Visible State	Specifies the state (On or Off) that makes the polygon visible.

9. You can click the following icons in the Draw toolbar to modify the properties of the polygon.

Click Icon	To
	Select a line style for the border.
	Select a color for the border.
	Select a color for painting the white part of the fill pattern.
	Select a pattern for the fill pattern.
	Select a color for painting the black part of the fill pattern.

4.1.10. Drawing Text Objects

1. In the Draw menu or Draw toolbar, click **Text** .
2. Move the cursor onto the screen where you want to draw a text object. A text object with default settings will display and move along with the cursor.
3. Click the desired position on the screen to place the text object. The upper-left corner of the bounding box of the text object will be at the clicked position.
4. Double-click the text object to bring up the Text Object dialog box and then modify the settings of the text object. This dialog box contains the following three pages:
 - **General**
Described in [Section 4.1.10.1.](#)
 - **Shape**
Described in [Section 4.3.4](#)
 - **Visibility**
Described in [Section 4.4.6.](#)

Note 1: You can use the Text toolbar to modify the properties of the text object's text instantly.

Note 2: You can use the Draw toolbar to modify the properties of the text object's shape instantly.

Tip: By default, the Auto Text Resizing on the Edit menu is checked and the related icon on the Edit toolbar is sunken. If you don't want to resize the text when resizing the object, you need to uncheck the Auto Text Resizing command on the Edit menu or click the sunken icon  on the Edit toolbar to make the font size fixed.





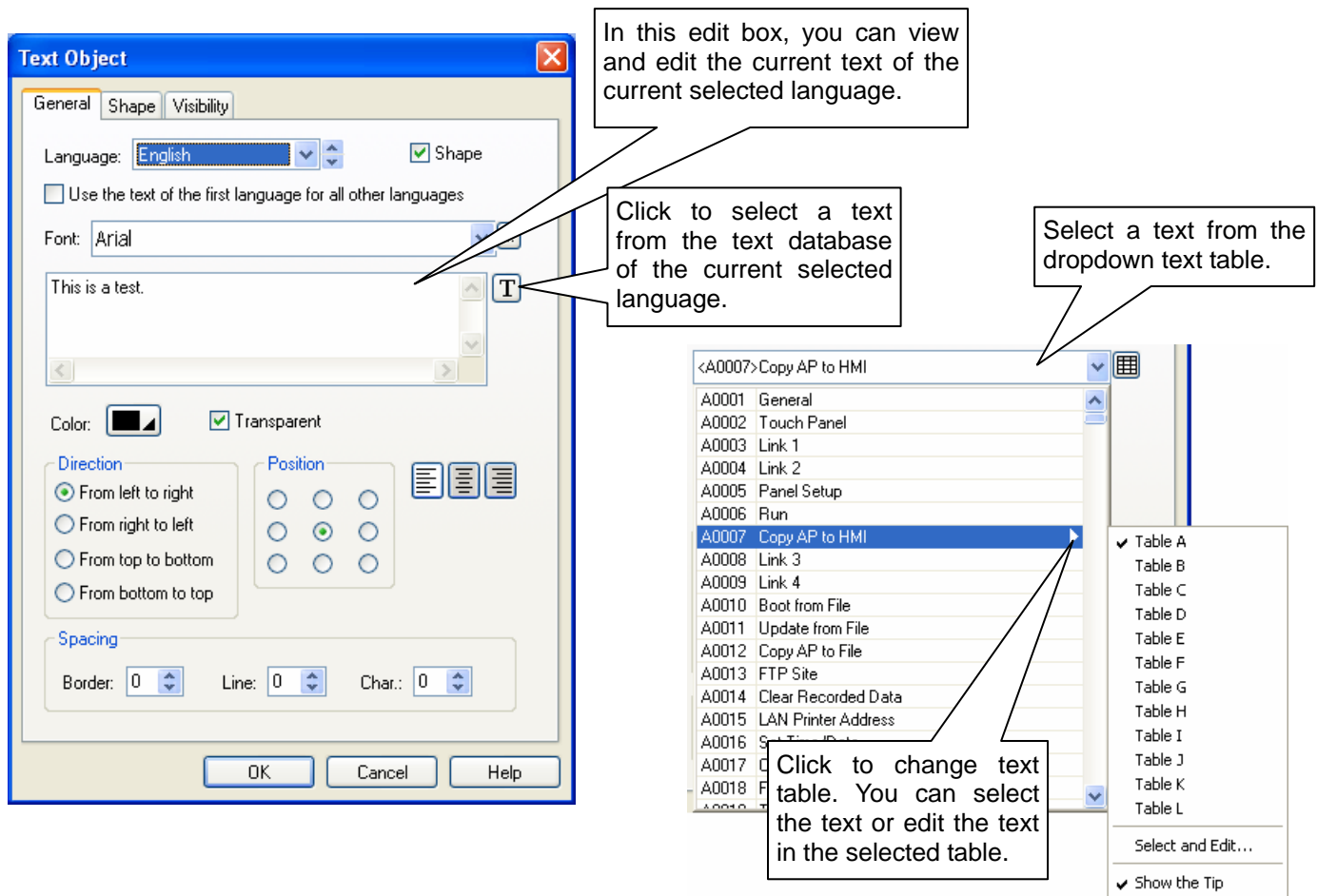

4.1.10.1. General Settings

This section describes how to define the general settings for text objects.



The above is an example of the General page of the Text Object dialog box.

The following table describes each property in the General page.



Property		Description										
Language		The language that you are setting the text for.										
Shape		Check this option if you want the text object to have a frame as its background. The Shape page appears in the dialog box when the option is selected.										
Use the text of the first language for all other languages		Check this item so the text object always shows the text of the first language regardless of what the current language is.										
Font		The font of the current text. You can use the drop-down list to select a font, or click  to bring up the Font Templates dialog box and select a font for the current text. You can change the font templates before selecting a font in that dialog box.										
Text	<Edit Box> / <Combo Box>	The current text of the currently selected language.										
	 / 	Click  to view and edit the text for the selected language in this edit box, or click  to select a text from dropdown text table that lists all the texts from Text Database. You can change the text database before selecting a text.										
Color		The color of the text. To specify the color, click the corresponding Color icon and select a color from the Color palette.										
Transparent		Check this item to make the background of the text transparent.										
BG Color		Specifies the background color of the text. This field is available when Transparent is not selected.										
Direction		Select one of the following directions to arrange the characters of the text. <table border="1" data-bbox="402 1025 1468 1505"> <thead> <tr> <th>Direction</th> <th>From left to right</th> <th>From right to left</th> <th>From top to bottom</th> <th>From bottom to top</th> </tr> </thead> <tbody> <tr> <td>Input text: An example</td> <td>An example</td> <td>elpmaxe nA</td> <td>A n e x a m p l e</td> <td>e l p m a x e n A</td> </tr> </tbody> </table>	Direction	From left to right	From right to left	From top to bottom	From bottom to top	Input text: An example	An example	elpmaxe nA	A n e x a m p l e	e l p m a x e n A
Direction	From left to right	From right to left	From top to bottom	From bottom to top								
Input text: An example	An example	elpmaxe nA	A n e x a m p l e	e l p m a x e n A								
Position 		The position of the text body.										
		The alignment of the text.										
Border Spacing		The margin (in pixels) to the border of the object's shape for the text body.										
Line Spacing		The distance (in pixels) between two adjacent lines of the text.										
Character Spacing		The distance (in pixels) between two adjacent characters of the text.										

4.1.11. Drawing Picture Objects

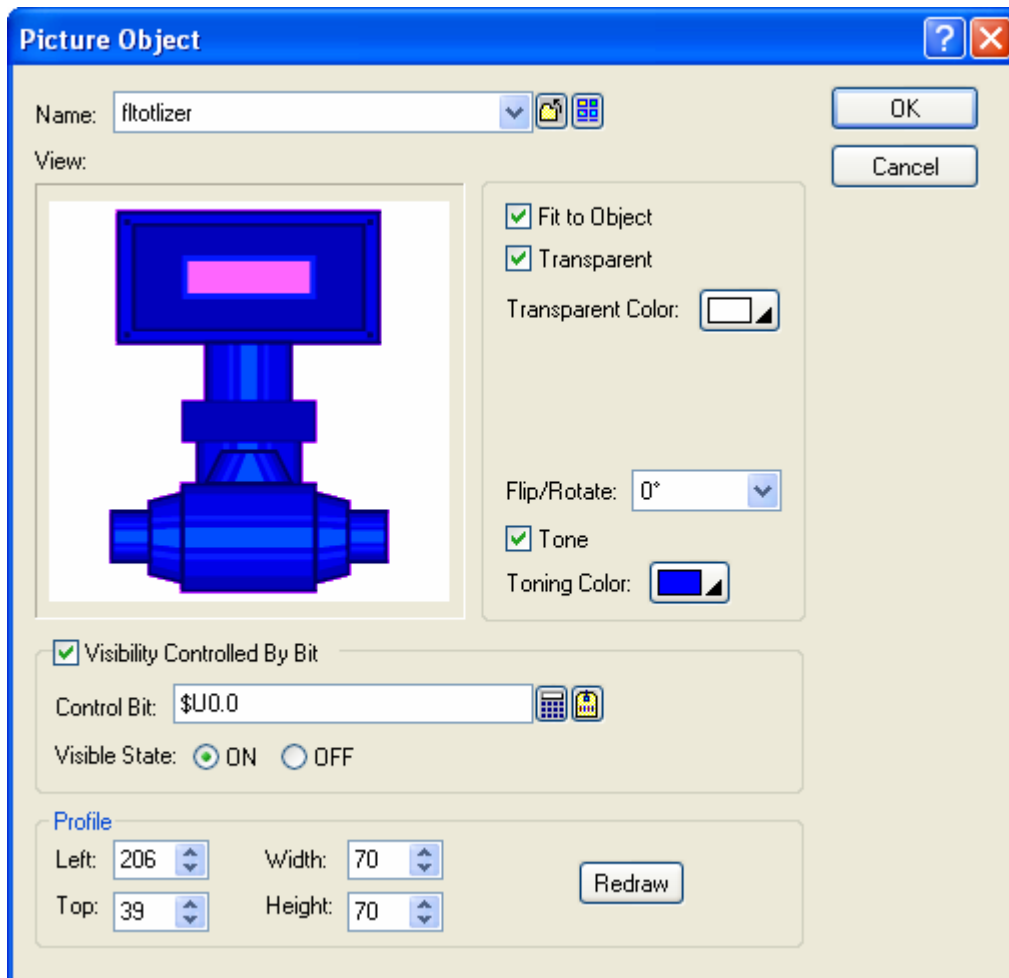

1. In the Draw menu or Draw toolbar, click **Picture** .
2. Move the cursor onto the screen where you want to draw a picture object. A picture object with default settings will display and move along with the cursor.
3. Click the desired position on the screen to place the picture object. The upper-left corner of the bounding box of the picture object will be at the clicked position.
4. Double-click the picture object to bring up the Picture Object dialog box. Select a picture and define the settings for the picture object in the dialog box. Note that you can use the Picture toolbar to modify the properties of the picture object instantly. The following is an example of the Picture Object dialog box.



The following table describes each property in the Picture Object dialog box.

Property	Description
Name	<p>The name of the picture that the object displays. You can use the drop-down list to select a picture from the picture database.</p> <p>Click  to select a picture from a file. After the selection, the software imports the picture of the selected file and saves the picture in the picture database.</p> <p>Click  to bring up the Select/Import from Library dialog box. Select a picture from a picture library file. After the selection, the software imports the selected picture from the selected library and saves the picture in the picture database.</p>
View	Shows the processed result of the selected picture according to the current settings.

Continued







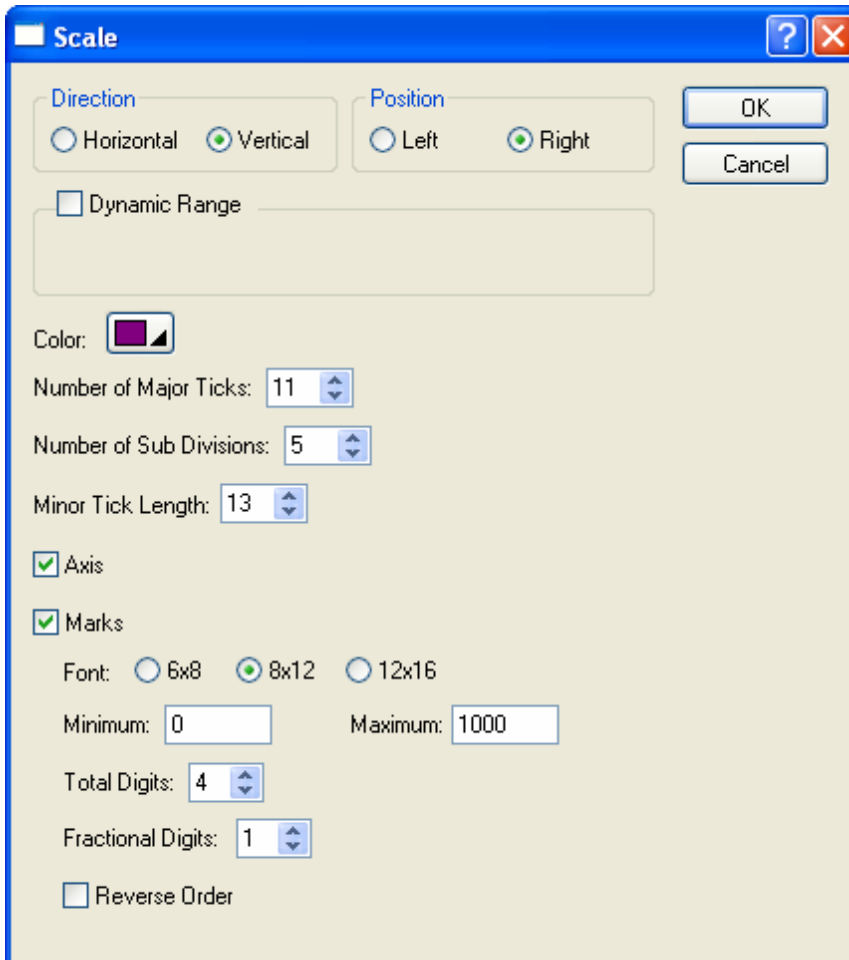
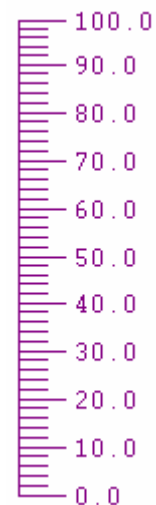

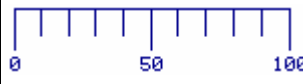

Property		Description																		
Fit to Object		Check this item so the picture can change its size automatically to fit inside the object.																		
Transparent		Check this item to make parts of the picture transparent. The transparent parts are pixels whose colors are identical to the specified transparent color. This item is available when the picture is not a black and white picture.																		
Transparent Color		The transparent color. This item is available when the picture is not a black and white picture.																		
FG Color		The color to paint the black part of a black and white picture. This item is available when the picture is a black and white picture.																		
BG Color		The color to paint the white part of a black and white picture. This item is available when the picture is a black and white picture.																		
Flip/Rotate		Specifies the method to flip or rotate the picture before drawing it. There are 8 options: <table border="1" data-bbox="555 685 1493 1131"> <thead> <tr> <th>Method</th> <th>Description</th> </tr> </thead> <tbody> <tr> <td>0°</td> <td>Do nothing</td> </tr> <tr> <td>90°</td> <td>Rotates the picture clockwise by 90 degrees</td> </tr> <tr> <td>180°</td> <td>Rotates the picture clockwise by 180 degrees</td> </tr> <tr> <td>270°</td> <td>Rotates the picture clockwise by 270 degrees</td> </tr> <tr> <td>X</td> <td>Flips the picture over the X axis</td> </tr> <tr> <td>90° & X</td> <td>Rotates the picture clockwise by 90 degree and flips it over the X axis</td> </tr> <tr> <td>Y</td> <td>Flips the picture over Y axis</td> </tr> <tr> <td>90° & Y</td> <td>Rotates the picture clockwise by 90 degree and flips it over the Y axis</td> </tr> </tbody> </table>	Method	Description	0°	Do nothing	90°	Rotates the picture clockwise by 90 degrees	180°	Rotates the picture clockwise by 180 degrees	270°	Rotates the picture clockwise by 270 degrees	X	Flips the picture over the X axis	90° & X	Rotates the picture clockwise by 90 degree and flips it over the X axis	Y	Flips the picture over Y axis	90° & Y	Rotates the picture clockwise by 90 degree and flips it over the Y axis
Method	Description																			
0°	Do nothing																			
90°	Rotates the picture clockwise by 90 degrees																			
180°	Rotates the picture clockwise by 180 degrees																			
270°	Rotates the picture clockwise by 270 degrees																			
X	Flips the picture over the X axis																			
90° & X	Rotates the picture clockwise by 90 degree and flips it over the X axis																			
Y	Flips the picture over Y axis																			
90° & Y	Rotates the picture clockwise by 90 degree and flips it over the Y axis																			
Tone		Check this item to tone the picture.																		
Toning Color		The color to tone the picture.																		
Visibility Control	Visibility Controlled By Bit	Check this option if the picture will be shown or hidden by the specified bit.																		
	Control Bit	Specifies the bit that shows or hides the picture object. Click  to enter the bit address. Click  to enter the bit tag.																		
	Visible State	Specifies the state (On or Off) that makes the picture visible.																		
Profile	Left	The X coordinate of the upper-left corner of the object.																		
	Top	The Y coordinate of the upper-left corner of the object.																		
	Width	The width of the object.																		
	Height	The height of the object.																		
	Redraw	Click this button to redraw the object on the screen with the current settings.																		

4.1.12. Drawing Scales

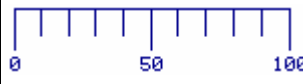
1. In the Draw menu or Draw toolbar, click **Scale** .
2. Move the cursor onto the screen where you want to draw a scale. A scale with default settings will display and move along with the cursor.
3. Click the desired position on the screen to place the scale. The upper-left corner of the bounding box of the scale will be at the clicked position.
4. Double-click the scale to bring up the Scale dialog box and then define the settings for the scale. The following is an example of the Scale dialog box. The corresponding scale is shown to the right of the dialog box.



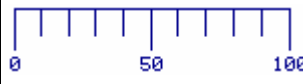

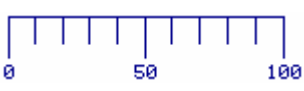
The following table describes each property in the Scale dialog box.

Property		Description															
Direction and Position		Select the direction and the position of the scale.															
		<table border="1"> <thead> <tr> <th>Direction</th> <th colspan="2">Horizontal</th> <th colspan="2">Vertical</th> </tr> <tr> <th>Position</th> <th>Top</th> <th>Bottom</th> <th>Left</th> <th>Right</th> </tr> </thead> <tbody> <tr> <td>Example</td> <td></td> <td></td> <td></td> <td></td> </tr> </tbody> </table>	Direction	Horizontal		Vertical		Position	Top	Bottom	Left	Right	Example				
		Direction	Horizontal		Vertical												
		Position	Top	Bottom	Left	Right											
Example																	
Dynamic Range	Dynamic Range	Check this item if you want the numbers of the scale ticks and the range of the scale marks to be dynamic, i.e. to be controlled by the specified variable.															
	Parameter Block	<p>Specifies the variable that controls the numbers of the scale ticks and the range of the scale marks. The variable is an array of four double-words (8 words). The following table describes the data members of the array.</p> <table border="1"> <thead> <tr> <th>Word #</th> <th>Data Type</th> <th>Description</th> </tr> </thead> <tbody> <tr> <td>0, 1</td> <td>32-bit unsigned integer</td> <td>The number of major ticks. The allowable range of this number is between 2 and 101.</td> </tr> <tr> <td>2, 3</td> <td>32-bit unsigned integer</td> <td>The number of divisions between two adjacent major ticks. The allowable range of this number is between 1 and 100.</td> </tr> <tr> <td>4, 5</td> <td>32-bit signed integer</td> <td>The minimum of the scale marks.</td> </tr> <tr> <td>6, 7</td> <td>32-bit signed integer</td> <td>The maximum of the scale marks.</td> </tr> </tbody> </table> <p>Example Assume a scale's dynamic range control block is \$U100. The following macro commands makes the scale look like this:</p>  <pre> \$U100 = 3 (UD) // The number of major ticks. \$U102 = 5 (UD) // The number of sub-divisions. \$U104 = 0 (SD) // The minimum of the scale marks. \$U106 = 100 (SD) // The maximum of the scale marks. </pre>	Word #	Data Type	Description	0, 1	32-bit unsigned integer	The number of major ticks. The allowable range of this number is between 2 and 101.	2, 3	32-bit unsigned integer	The number of divisions between two adjacent major ticks. The allowable range of this number is between 1 and 100.	4, 5	32-bit signed integer	The minimum of the scale marks.	6, 7	32-bit signed integer	The maximum of the scale marks.
Word #	Data Type	Description															
0, 1	32-bit unsigned integer	The number of major ticks. The allowable range of this number is between 2 and 101.															
2, 3	32-bit unsigned integer	The number of divisions between two adjacent major ticks. The allowable range of this number is between 1 and 100.															
4, 5	32-bit signed integer	The minimum of the scale marks.															
6, 7	32-bit signed integer	The maximum of the scale marks.															
Color		The color of the scale. To specify the color, click the corresponding Color icon and select a color from the Color palette.															
Number of Major Ticks		The number of major ticks. The minimum you can specify is two.															
Number of Sub Divisions		The number of divisions between two adjacent major ticks. The minimum you can specify is one.															
Minor Tick Length		The length of minor ticks.															
Axis		Check this item if you want the scale to have an axis.															
Marks	Marks	Check this option if you want the scale to have marks.															
	Font	The font of the marks.															
	Minimum	The minimum of the marks. It is a 32-bit integer.															
	Maximum	The maximum of the marks. It is a 32-bit integer.															
	Total Digits	The total digits to be displayed for the marks.															
	Fractional Digits	The number of fractional digits for the marks. For example, when the Maximum is 5000, the Total Digits is 4, and the Fractional Digits is 2, the mark for the Maximum will be 50.00.															
	Reverse Order	Check this option if you want the marks of the scale to show in reverse order. In normal order, the maximal mark is at the right end or top end of the scale. In reverse order, the maximal mark is at the left end or bottom end of the scale.															

4.1.13. Drawing Tables

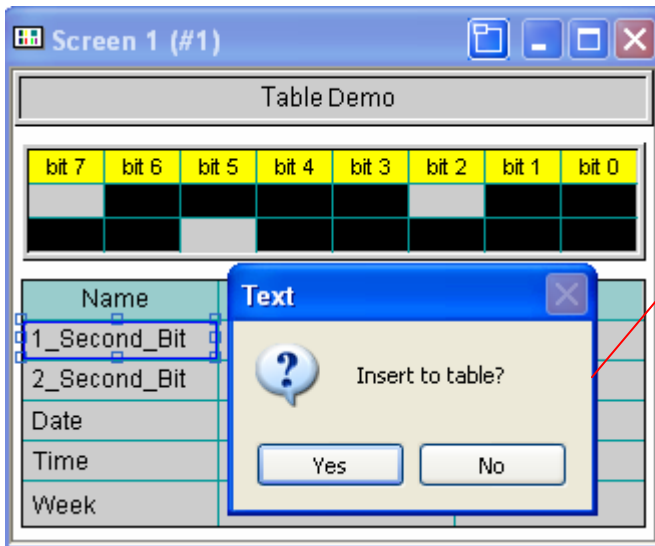
1. In the Draw menu or Draw toolbar, click **Table** .
2. Move the cursor onto the screen where you want to draw a table. A table with default settings will display and move along with the cursor.
3. Click the desired position on the screen to place the table. The upper-left corner of the table will be at the clicked position.
4. Use drag-and-drop editing to move an existing object into an empty cell of the table. If the object is allowed to be placed in the cell, a message box will pop-up to confirm the operation. The following is an example of object insertion with the confirmation dialog box.





- If you click Yes to insert the object to the table, the object will be part of the table. Any modifications such as moving the table, resizing the table, deleting the table... will be applied to the objects of the table at the same time.
- If you click No to cancel the operation, the object will move to the specified position and float over the table.

Note: Only 23 types of objects can be placed in the cells of the table. The supported objects are Picture, Dot, Text, Bit Button, Toggle Switch, Word Button, Multistate Switch, Screen Button, Function Button, Keypad Button, Numeric Display, Numeric Entry, ASCII String Display, ASCII String Entry, Bit Lamp, Multistate Lamp, Time Display, Date Display, Day-of-Week Display, Message Display, Bar Graph, Picture Display, GIF Display, and Advanced Numeric Display.

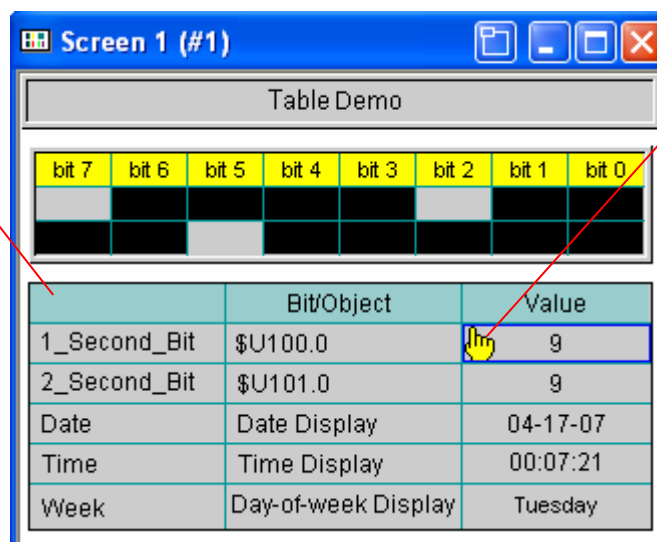

5. Click the cell inside the table. If the cell contains the object, there will be the  icon on the upper-left corner of the cell. The following is an example showing you how to edit the object in the table.

This is an empty cell where you can place an object.



➤ Left-click the icon and hold down the button. When the cursor changes to , move the object out of the table.

➤ Double click the icon to bring up the properties dialog box of the corresponding object and then define the settings of object for the selected cell.

6. Position the mouse point over one of the grid lines. When the cursor changes to  or , drag the line until the column is the width and the row is the height you want.

Name	Bit/Object	Value
1_Second_Bit	\$U100.0	9
2_Second_Bit	\$U101.0	9
Date	Date Display	04-17-07
Time	Time Display	00:07:21
Week	Day-of-week Display	Tuesday

Drag the line to adjust the width of the column.

Drag the line to adjust the height of the row.

Note: You can adjust the width of the column when the Distribute Columns Evenly is not selected in the general page of the Table dialog box. And you can adjust the height of the row when the Distribute Rows Evenly is not selected in the general page of the Table dialog box.

7. Double-click anywhere inside the table, other than the  icon, to bring up the Table dialog box and then define the settings for the table. This dialog box contains the following two pages:
- **General**
Described in [Section 4.1.13.1](#).
 - **Cell**
Described in [Section 4.1.13.2](#).

4.1.13.1. General Settings

This section describes how to define the general settings for the table objects. The following is an example of the General page of the Table Object dialog box.

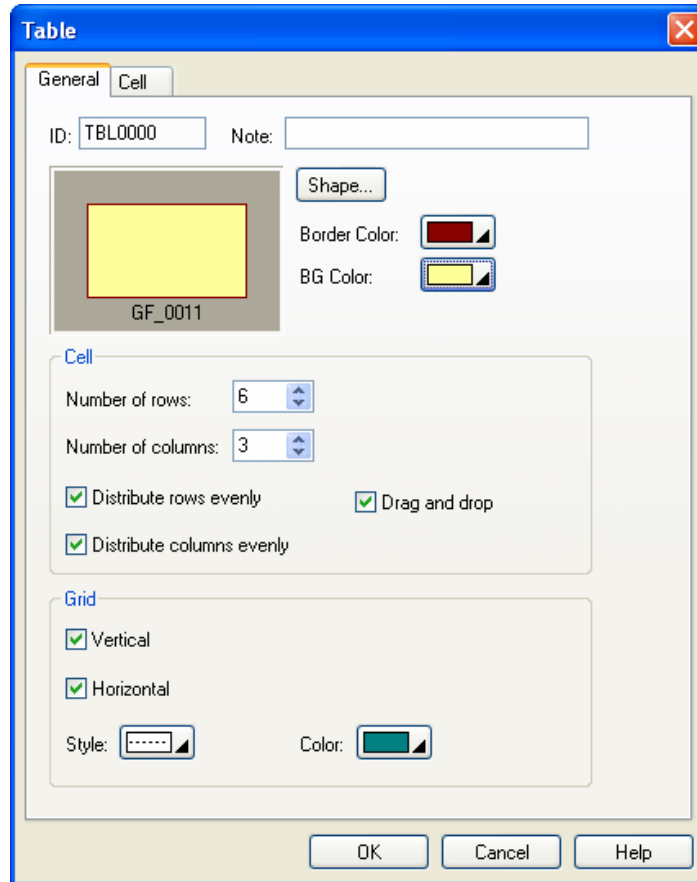

The following table describes each property in the General page of the Table dialog box.

Property		Description
ID		The object's identifier is generated when the object is created and is unchangeable. The identifier is unique within the screen where the object is located. The format of the IDs for the tables is TBLnnnn.
Note		You can type a note for the object.
Shape settings		For details about the following properties, see Section 4.3.4 Setting up the Shape of an Object . Shape... , Border Color, BG Color
Cell	Number of rows	Specifies the number of rows in the table.
	Number of columns	Specifies the number of columns in the table.
	Distribute rows evenly	Check this option if you want the rows of the table to be always distributed evenly. Uncheck this option if you want to adjust the heights of the rows.
	Distribute columns evenly	Check this option if you want the columns of the table to be always distributed evenly. Uncheck this option if you want to adjust the widths of the columns.
	Drag and drop	Check this option so you can drag and drop an object into a cell of the table. Note that not all kinds of objects can be placed in the cells of the table.
Grid	Vertical	Check this option if you want the table to have vertical grid lines.
	Horizontal	Check this option if you want the table to have horizontal grid lines.
	Style	Specifies the style for the grid lines.
	Color	Specifies the color for the grid lines.

4.1.13.2. Cell Settings

The following is an example of the Cell page of the Table Object dialog box and the Select Object Dialog box when the Insert Button is clicked.

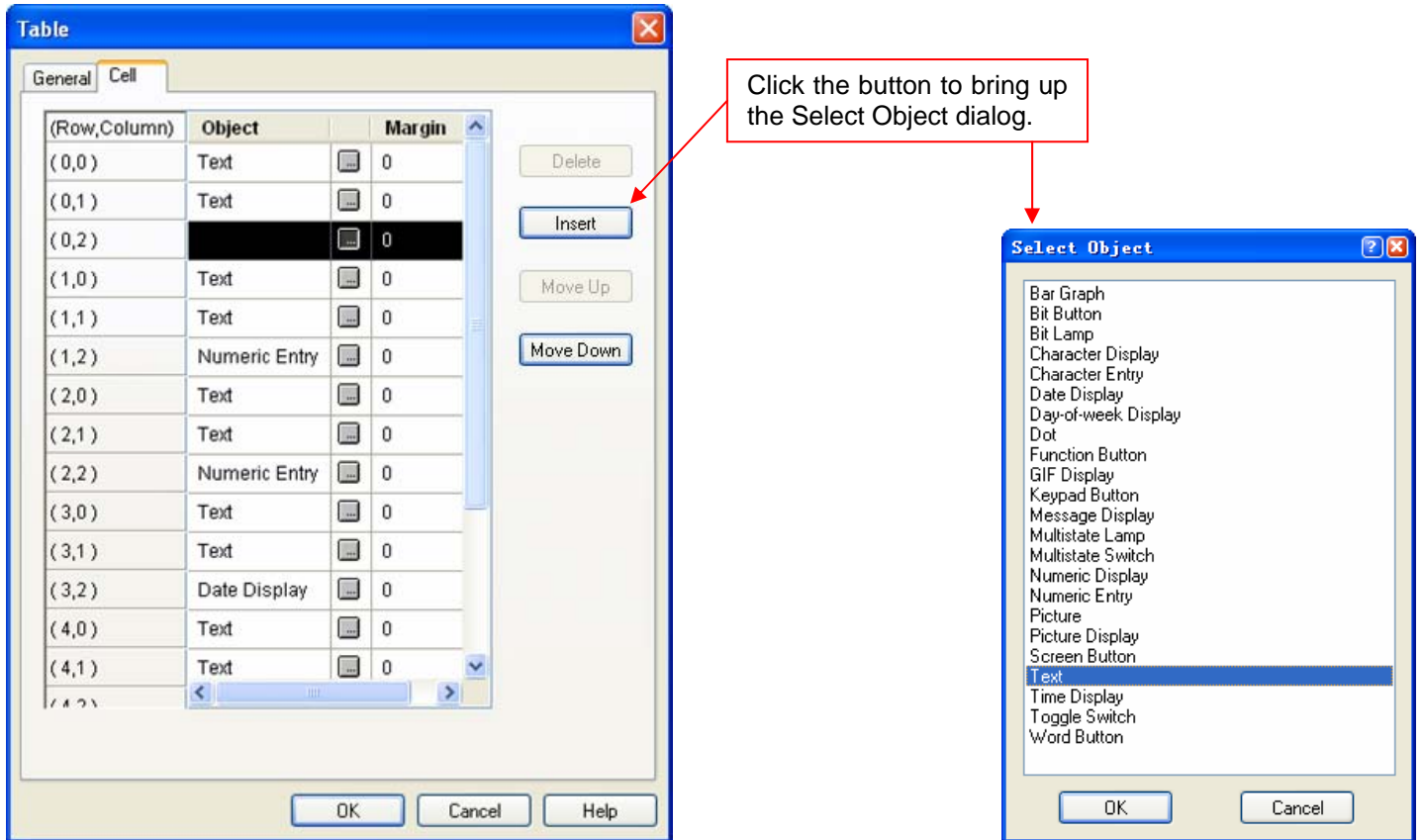

The following table describes each property in the Cell page of the Table dialog box. To make the buttons available, you need to select a row. To select a row, left-click the (Row, Column) column.

Property	Description
(Row,Column)	The location of the cell.
Object	The type of the specified object. If the field is empty, the cell has no object inserted and it is called empty cell.
	Click the button to bring up the properties dialog box of the specified object and define the settings of the object for the selected cell. The button is available when the Object field is not empty.
Margin	The distance in pixels between the object boundary and the cell border. Select a number between 0 and 10.
Delete	Click the button to clear the contents of the selected cell. The button is available when the selected cell is not empty.
Insert	Click the button to bring up the Select Object dialog box shown above. Select an object type listed in the dialog to create a new object for the selected cell. The button is available when the selected cell is empty. Note: The table won't allow the insertion of the type of object which is not listed in the dialog.
Move Up	Click the button to move the selected cell before the previous cell. It will not be available when multiple rows are selected, no row is selected, or the first row is selected.
Move Down	Click the button to move the selected cell after the next cell. It will not be available when multiple rows are selected, no row is selected, or the last row is selected.

4.2. Editing Objects

In this section you will learn how to select the objects first and then move around, copy, or edit the selections without affecting the rest of the screen.

4.2.1. Selecting and De-selecting Objects

■ Selecting Objects

To select an object, move the mouse to the object you want to select and then click the left button.

To add an object to the selection, use Shift + Click.

To select all objects of the active screen, use Ctrl + A, or use the Select All command on the Edit menu.

■ Selecting Objects by a Rectangular Area

Left-click on the blank area of the screen, and hold the button to begin your selection. Where you click will become one of the corners of the rectangular selection area. Then drag the mouse diagonally. Release the mouse button when you reach the position that you want the opposite corner of the rectangular area to be.

Each of the selected objects will have blue square-shaped tabs around it. The object with solid tabs is the reference object.

■ De-selecting Objects

To de-select objects, either click the blank area of the screen, or make a new selection.

4.2.2. Basic Operations with the Selected Area

■ Moving Objects





Left-click anywhere inside the selected object and hold down the button. When the cursor turns changes to , drag the mouse to move the selection to another area of the screen. The selection will "float" over the rest of the screen, allowing you to position it wherever you like. Release the mouse button to "let go" of the selection.

■ Grouping or Ungrouping Objects

To group the selection, click  on the edit toolbar, or use the Group command on the Edit menu or on the object pop-up menu. After you have grouped a selection that includes at least two objects, you can copy, move or resize all objects in a group as a single unit. You can select an object within the group and change its properties without ungrouping. You can also save the group to the object library and use this object group in an animated graphic.

To ungroup the selected group, click  on the edit toolbar, or use the Ungroup command on the Edit menu or on the object pop-up menu. After ungrouping the objects, the objects within the group will be restored to the single ones.

■ Resizing Objects

The square-shaped tabs around your object can be re-sized. You can resize by clicking on the square-shaped tabs located at the corners and the middle sections of the bound rectangle area and holding the mouse button down. When the cursor changes to  or  or  or , drag the mouse to change the size of the selection. Release the mouse button when the selection is the size you like. You can make it bigger or smaller, and achieve a distorted effect by "squashing" or "stretching" the selection to make it either wider/narrower or taller/shorter than its original proportions.

Tip: You can't resize more than one object at a time unless you group multiple objects before resizing.

■ Auto Text Resizing

To automatically scale the text of the object when resizing the object, click  on the edit toolbar if it is raised, or use the Auto Text Resizing command on the Edit menu.

Tip: The Auto Text Resizing command is checked and the icon is sunken by default. If you don't want to resize the text when resizing the object, you need to uncheck the Auto Text Resizing command or click the sunken icon to make the font size fixed.

■ Pinning or Unpinning Objects

To pin the selection so that it cannot move, click  on the edit toolbar, or use the Pin command on the Edit menu or on the object pop-up menu.

To unpin the selection so that it can move again, click  on the edit toolbar, or use the Unpin command on the Edit menu or on the object pop-up menu.

Tip: Pinned objects can still be resized.

■ Copying or Cutting and Pasting Objects

To copy a selection from the current screen and place it on the Windows™ clipboard, press Ctrl+C, or click  on the standard toolbar, or use the Copy command on the Edit menu or on the object pop-up menu.

To cut a selection from the screen, press Ctrl+X, or click  on the standard toolbar, or use the Cut command on the Edit menu or on the object pop-up menu.

After Copying or Cutting, you can paste the selection by pressing Ctrl+V, or click  on the standard toolbar, or use the Paste command on the Edit menu or on the object pop-up menu.

To copy and paste the selection by mouse, press and hold down the Ctrl key, and then left-click the selection and hold down the button. When the cursor changes to , drag the mouse to copy the selection to another area of the screen. The picture on the right is an example.

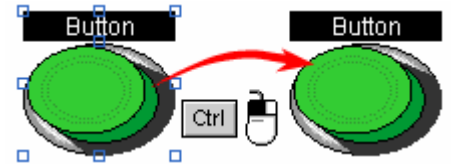

Tip: Cut and Paste are good for moving objects around within the screen or to another screen.

Copy and Paste are good for duplicating objects from the current screen to other screens.

By pasting multiple times on the current screen, you can achieve a cascading effect.

By pasting once to a different screen, the position of the pasted object will be the same as the copied object from the original screen.

■ Deleting Objects

To delete a selection, press Del, or use the Delete command on the Edit menu, or on the object pop-up menu. When you use Delete, whatever is in the selection will be deleted.

■ Undo

To reverse the last action, press Ctrl+Z, or use the Undo command on the Edit menu.

■ Redo

To reapply the actions that were previously canceled by the Undo command, press Ctrl+Z, or use the Redo command on the Edit menu.

■ Keyboard Shortcuts

Shortcut	Operation	Shortcut	Operation	Shortcut	Operation
【Ctrl+N】	New Project	【Ctrl+X】	Cut	【Ctrl+D】	Duplicate
【Ctrl+O】	Open Project	【Ctrl+C】	Copy	【Ctrl+F】	Find
【Ctrl+S】	Save	【Ctrl+V】	Paste	【Ctrl+R】	Replace
【Ctrl+Z】	Undo	【Ctrl+Click+move】	Copy & Paste	【Ctrl+A】	Select All
【Ctrl+Y】	Redo	【Del】	Delete	【Shift+Click】	Multiple Select
				【Ctrl+Click】	Reference Object Select

4.2.3. Duplicating Objects

To duplicate the selected object, use the Duplicate... command on the Edit menu or on the object pop-up menu. After the duplicate command is executed, the following dialog will pop-up and allow you to set how to duplicate objects.

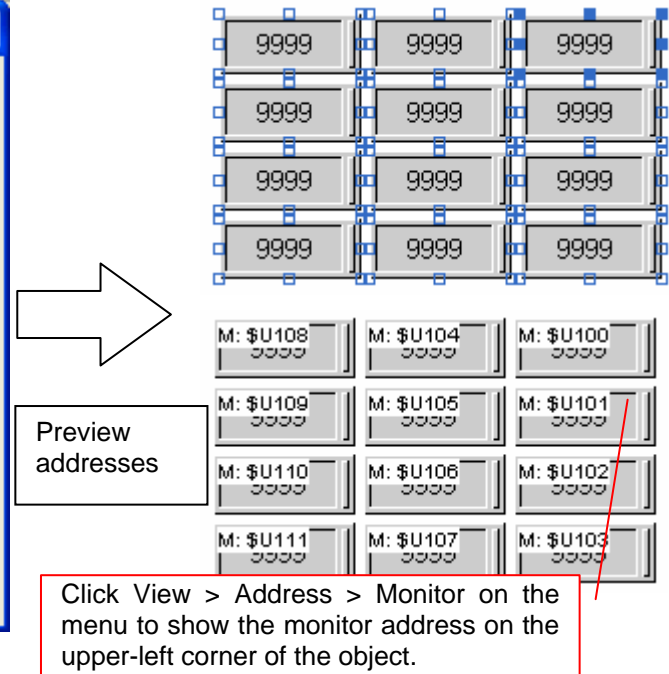
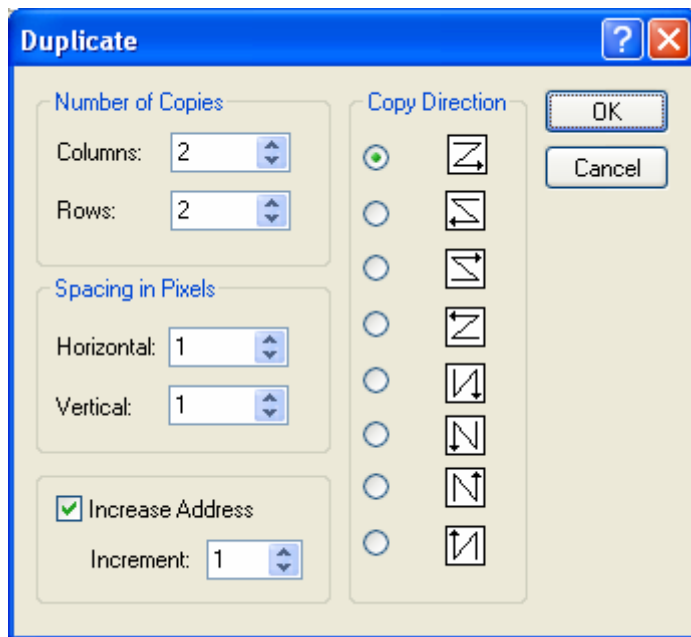











The following table describes each property in the Duplicate dialog.

Property		Description
Number of Copies	Columns	The total number of columns.
	Rows	The total number of rows.
Spacing in Pixels	Vertical	The distance (in pixels) between two adjacent objects in the vertical direction.
	Horizontal	The distance (in pixels) between two adjacent objects in the horizontal direction.
Increase Address		Check this item so the address of each duplicate will be increased to a specified increment over the previous object.
Increment		The increase amount.
Copy Direction		From top to bottom, place the duplicates row by row. In the same row, place the duplicate to the right of the previous object.
		From top to bottom, place the duplicates row by row. In the same row, place the duplicate to the left of the previous object.
		From bottom to top, place the duplicates row by row. In the same row, place the duplicate to the right of the previous object.
		From bottom to top, place the duplicates row by row. In the same row, place the duplicate to the left of the previous object.
		From left to right, place the duplicates column by column. In the same column, place the duplicate below the previous object.
		From right to left, place the duplicates column by column. In the same column, place the duplicate below the previous object.
		From left to right, place the duplicates column by column. In the same column, place the duplicate above the previous object.
		From right to left, place the duplicates column by column. In the same column, place the duplicate above the previous object.

4.2.4. Aligning Objects



To arrange the selected objects on a screen, you need to select a reference object from within the selection and then press the icon on the toolbar or click the menu item listed as below. To do a multiple selection, use Shift + Click. To select a reference object from the selection, use Ctrl + Click.

Use the **Align** commands on the Edit menu to arrange objects/drawings on a screen. Select an object or drawing by single-clicking on it, then hold down the **Shift** key while clicking on the other objects or drawings to be aligned with it. When all of the objects or drawings to be aligned are selected, choose one of the commands in the **Align** submenu or directly click a specified icon in the **Edit Toolbar**.





Icon	Menu Item	Description	
	Align	Left	Align the left sides of selected objects to the left side of the reference object. All the objects move horizontally so their left sides are in line with the left side of the reference object.
		Vertical Center	Align the vertical centers of selected objects to the vertical center of the reference object. All the objects move horizontally so their vertical centers are in line with the vertical center of the reference object.
		Right	Align the right sides of selected objects to the right side of the reference object. All the objects move horizontally so their right sides are in line with the right side of the reference object.
		Top	Align the tops of the selected objects to the top of the reference object. All the objects move vertically so their tops are in line with the top of the reference object.
		Horizontal Center	Align the horizontal centers of selected objects to the horizontal center of the reference object. All the objects move vertically so their horizontal centers are in line with the horizontal center of the reference object.
		Bottom	Align the bottoms of selected objects to the bottom of the reference object. All the objects move vertically so their bottoms are in line with the bottom of the reference object.
		To Grid	Select or deselect the option of aligning objects to grid points.
	Nudge	Left	Nudge the selection left. When the Snap to Grid option is not selected, all objects of the selection move one pixel left. When the Snap to Grid option is selected, each object of the selection moves left to where its upper-left corner aligns to the nearest grid point.
		Right	Nudge the selection right. When the Snap to Grid option is not selected, all objects of the selection move one pixel right. When the Snap to Grid option is selected, each object of the selection moves right to where its upper-left corner aligns to the nearest grid point.
		Up	Nudge the selection up. When the Snap to Grid option is not selected, all objects of the selection move one pixel up. When the Snap to Grid option is selected, each object of the selection moves up to where its upper-left corner aligns to the nearest grid point.
		Down	Nudge the selection down. When the Snap to Grid option is not selected, all objects of the selection move one pixel down. When the Snap to Grid option is selected, each object of the selection moves down to where its upper-left corner aligns to the nearest grid point.

4.2.5. Making Objects Same Size

Make objects in the selection the same size as the reference object by first selecting the objects using Ctrl + Click, press the icon on the toolbar or click the menu item listed below.

Icon	Menu Item		Description
	Make Same Size	Width	Make the selected objects have the same width as the reference object.
		Height	Make the selected objects have the same height as the reference object.
		Both	Make the selected objects have the same width and height as the reference object.

4.2.6. Arranging the Order of Objects

Icon	Menu Item		Description
	Layer	Bring to Top	Bring the selection to the top.
		Bring Forward	Bring the selected object one layer up.
		Send Backward	Send the selected object one layer down.
		Send to Bottom	Send the selection to the bottom.
	Set Order		Start the order setting process for the objects of the active screen. For details, please see Section 4.2.6.1 Changing the Order of Objects

4.2.6.1. Changing the Order of Objects

The object order in the software is the order in which the selection cursor moves the input focus from one object to the next within a screen. Usually the order proceeds from left to right and from top to bottom in a screen. In the model with programmable keys such as 037-LSK, the Data Entry Object receives input focus in the specified order by clicking direction keys. In a touch panel, you can use the function button to select a data entry object with the order number previous or next to the current selection.

The object order is also the display order. If the screen contains overlapping objects, changing the order will change the display sequence of the objects. The objects that come later in the order are always displayed on top of any overlapping objects that precede them in the order.

■ Viewing order

To view the current order of all objects in the screen, click Set Order on the Edit menu.

■ Changing order

To change the order for all objects in the screen

- 1) On the Edit menu, click Set Order
A Number in the upper-left corner of each object shows its place in the current order
- 2) Set the order by clicking each object in the order that you want the objects to be displayed. The ordering number starts from 1.
- 3) Click the blank field on the screen to exit Set Order mode

The following is an example of the object ordering.



AAAAAAAAAAAAAAAAAAAAAAAAAAAAAAAA			
Communications:	Disabled	↑	+
Port:	COM1		
Baud Rate:	4800	↓	-
Data Bits:	7 bits		
Parity:	None		
Stop Bit:	1 bit		
Command Delay:	99		
Retry Times:	99	OK	
Timeout Time:	99		
Panel Address:	999	Cancel	
PLC Address:	99999		

28	AAAAAAAAAAAAAAAAAAAAAAAAAAAAAAAA		
1	Communications:	2	Disabled
3	Port:	4	COM1
5	Baud Rate:	6	4800
7	Data Bits:	8	7 bits
9	Parity:	10	None
11	Stop Bit:	12	1 bit
13	Command Delay:	14	99
15	Retry Times:	16	99
17	Timeout Time:	18	99
19	Panel Address:	20	999
21	PLC Address:	29	99999
		22	↓
		24	↓
		23	↓
		25	↓
		26	OK
		27	Cancel

If the screen is running on 037-LSK, click the down or right direction key to move the selection in 2-4-6-8-10-12-14-16-18-20-29 sequence. If the screen is running on the touch panel, click the function button  to move the selection in the same sequence. The text objects with 1,3,5...order number are not data entry object, so they won't receive the selection and are not listed in the sequence.

4.3. Designing Object Appearance









There are four common components of object appearance. They are described in the following table:

Appearance Component	Description								
Shape	<p>The shape of an object can either be a graphical shape or a picture shape. The following are examples of graphical shapes</p>  <p>The following are examples of picture shapes.</p>  <p>The software provides many graphical shapes for you to choose from. For details, see Section 4.3.3 Selecting a Graphical Shape. The color or the pattern of a graphical shape is dependent on the state of the associated object. You need to specify the color or pattern settings of a graphical shape for each state of the associated object. For details, see Section 4.3.1 Selecting a Color and Section 4.3.2 Selecting a Pattern.</p> <p>If you want an object to have a picture shape, check the item Picture Shape in the General Page of the object's property dialog box. You can select a picture from the picture database or import a picture from a library file for the shape of an object. Any picture with the format of BMP, JPG, or WMF can be a picture shape. When a picture is used as a shape, the shape is state independent, i.e. the same look appears for all (object) states. If you want a picture shape to display the object state and/or show the touch action, you need to select a picture group as the shape. For details of picture groups, please see Section 2.2.3.2 Picture Groups</p> <p>To know how to set a shape, see Section 4.3.4 Setting up the Shape of an Object.</p>								
Inner Label	<p>An inner label is a label inside the associated object. It has the same number of states as the associated object. You need to specify the text settings and the picture settings of an inner label for each (object) state. Inner labels are language dependent. You need to specify the text of an inner label for each language as well. Note that not all objects can have inner labels and some objects can have just text or a picture as their inner label. To know how to set an inner label, see Section 4.3.5 Label Settings.</p>								
VFTA (Visual Feedback for Touch Action)	<p>A button or switch can give the operator one of the following visual feedbacks when it is touched:</p> <table border="1" data-bbox="443 1574 1509 1776"> <thead> <tr> <th data-bbox="443 1574 683 1612">Visual Feedback</th> <th data-bbox="691 1574 1509 1612">Description</th> </tr> </thead> <tbody> <tr> <td data-bbox="443 1624 683 1662">Sunken</td> <td data-bbox="691 1624 1509 1662">Shifts the inner label to the lower-right corner by one or two pixels.</td> </tr> <tr> <td data-bbox="443 1673 683 1733">Back</td> <td data-bbox="691 1673 1509 1733">Fills the area inside the border of the shape with the shape's FG Color.</td> </tr> <tr> <td data-bbox="443 1744 683 1776">Outline</td> <td data-bbox="691 1744 1509 1776">Outlines the object with the shape's FG Color.</td> </tr> </tbody> </table>	Visual Feedback	Description	Sunken	Shifts the inner label to the lower-right corner by one or two pixels.	Back	Fills the area inside the border of the shape with the shape's FG Color.	Outline	Outlines the object with the shape's FG Color.
Visual Feedback	Description								
Sunken	Shifts the inner label to the lower-right corner by one or two pixels.								
Back	Fills the area inside the border of the shape with the shape's FG Color.								
Outline	Outlines the object with the shape's FG Color.								
External Label	<p>An external label is a label outside of but still attached to the associated object. Unlike inner labels, external labels are state independent. They have the same look for all (object) states. However, external labels are language dependent. You need to set the text of an external label for each language. External labels are touch insensitive. Touching an external label will not activate the associated object. Note that not all objects can have an external label. To know how to set an external label, see Section 4.3.8 External Label Settings.</p>								

The following table shows the common appearance components that each object type can have:

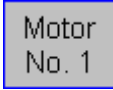
Object Types	Shape		Inner Label		VFTA	External Label
	Graphical Shape	Picture Shape	Text	Picture		
Bit Button, Toggle Switch, Screen Button, Word Button, Multi-state Switch, Radio Button Group	•	•	•	•	•	•
Function Button, Keypad Button, Page Selector	•	•	•	•	•	
Step Button	•		•	•	•	•
Bit Lamp, Multi-state Lamp,	•	•	•	•		•
Message Display	•		•			•
Picture Display	•			•		•
Day-of-week Display	•		•			
Meter	•	•				
Slide Switch, Numeric Entry, Numeric Display, Advanced Numeric Display, ASCII Character Entry, ASCII Character Display, Bar Graph	•					•
Time Display, Date Display, Pie Graph, Line Chart, Scatter Chart, Alarm Display, Historic Data Display, Historic Trend Graph, Single Record Line Chart, Operation Log Display, Recipe Selector, Recipe Table, Sub-link Table, Static Text, Table	•					
Animated Graphic				•		

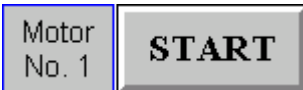
The orders of drawing the common appearance components are shown in the following table with examples:

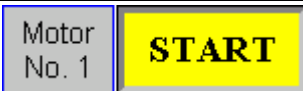
Step	Draw	Example 1	Example 2	Description
1	Shape			Described in Section 4.3.4
		A picture group that supports the pressed look	A graphical shape named SW_0023	
2	Picture of Inner label		(None)	Described in Section 4.3.5.2
3	Text of inner label	HELP	START	Described in Section 4.3.5.1
4	VFTA	(None)	Back (FG Color is )	
5	External label	(None)		Described in Section 4.3.8
Final Appearance (When untouched)				
Final Appearance (When touched)				

4.3.1. Selecting a Color

■ Color Icons

In a dialog box, a color icon is associated with a property that requires a color. It shows the color of the current selection and you can click it to bring up the Color palette. With the Color palette, you can select a color for the associated property. The following is a Color icon showing that the current selection is yellow.



■ Color Palette

With the Color palette, you can: 1) Select a color from a set of predefined colors, 2) Customize a set of user colors, and 3) Select a color from a set of user colors.

Usually, you click a Color icon to bring up the Color palette. The following shows the pages of the Color palette.

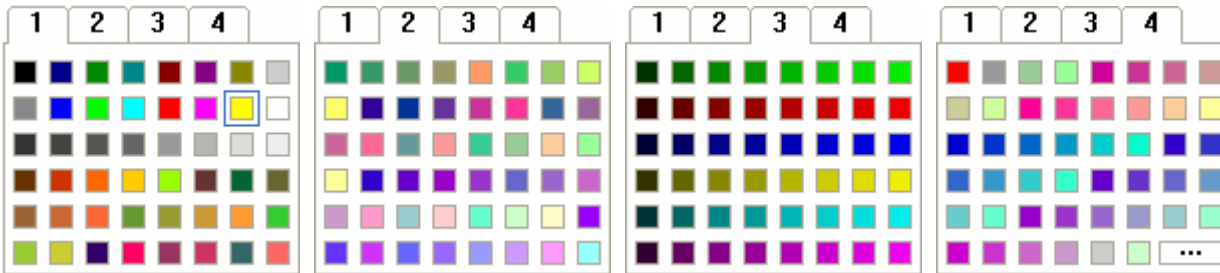

On page 1, the yellow block is outlined to indicate that it is the current selection. To select a color, click on that color block. To select a page, click on that page's number tab. To cancel the operation click on any position other than the color blocks and the number tabs. Page 1, 2, and 3 contain the predefined colors. Page 4 contains the user colors. To customize user colors, click to bring up the Define Custom Color dialog box as shown below.

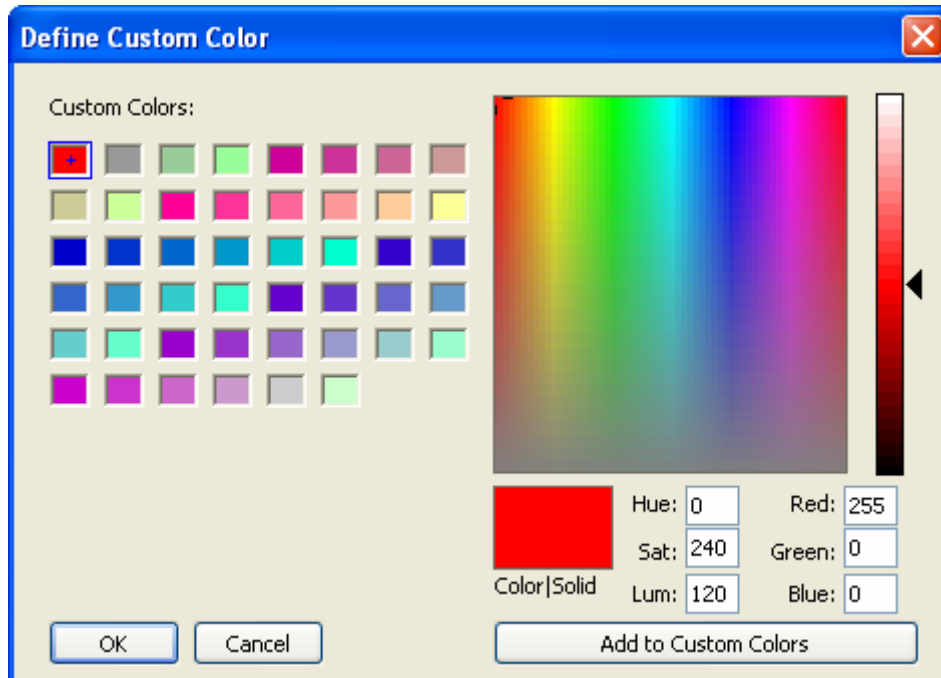

4.3.2. Selecting a Pattern

■ Pattern Icons

In a dialog box, a Pattern icon is associated with a property that requires a pattern. It shows the pattern of the current selection and you can click it to bring up the Pattern palette. With the Pattern palette, you can select a pattern for the associated property. The following is a Pattern icon showing that the current selection is the “big dashes”.



■ Pattern Palette

With the Pattern palette, you can select a pattern from a set of predefined patterns. Usually, you click a Pattern icon to bring up the Pattern palette as shown below.

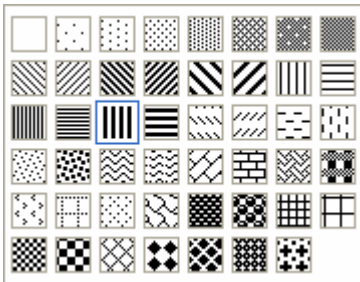



The “big dashes” block is outlined to indicate that it is the current selection. To select a pattern, click on that pattern block. To cancel the operation, click on any position other than the pattern blocks.

4.3.3. Selecting a Graphical Shape

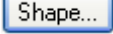
■ Shape Buttons

In an object’s property dialog box, you can click the shape button  to bring up the Shape palette. With the Shape palette, you can select a graphical shape as the shape of the associated object.

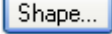
■ Shape Palette

With the Shape palette, you can select a graphical shape for an object. Usually, you click  to bring up the Shape palette. The Shape palette contains several pages of graphical shapes. To select a graphical shape, click on that graphical shape. To select a page, click on that page’s number tab. To cancel the operation, click the close button  to close the Shape palette.

There are four sets of graphical shapes available for your applications. Each of them is suitable for certain kinds of objects. The Shape palette shows the set that is suitable for the type of object concerned. The four sets of shapes are shown below.

Graphical shapes for buttons and switches

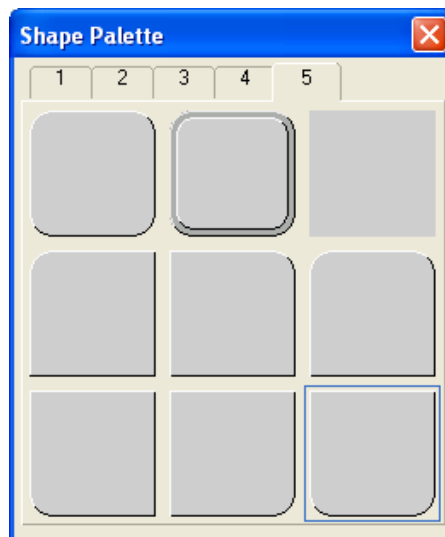
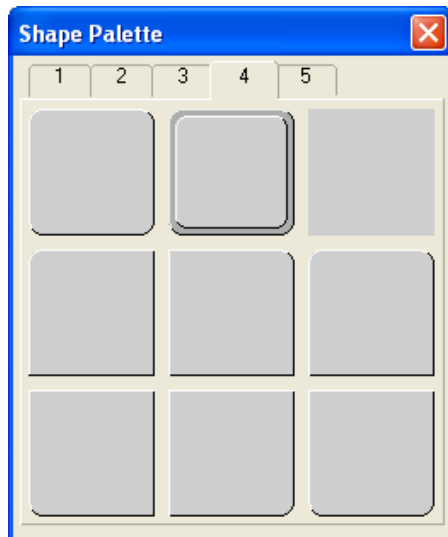
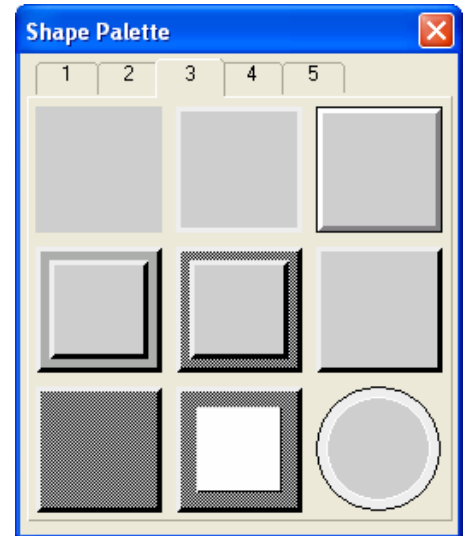
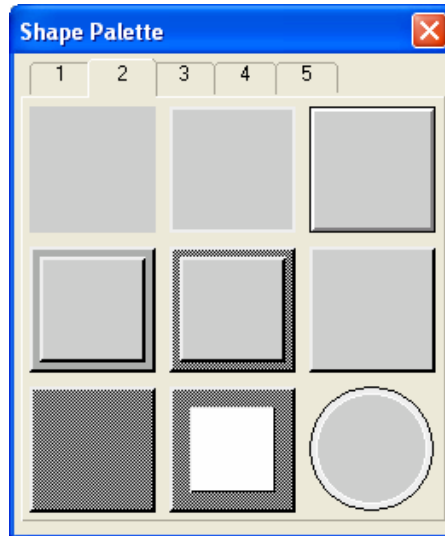
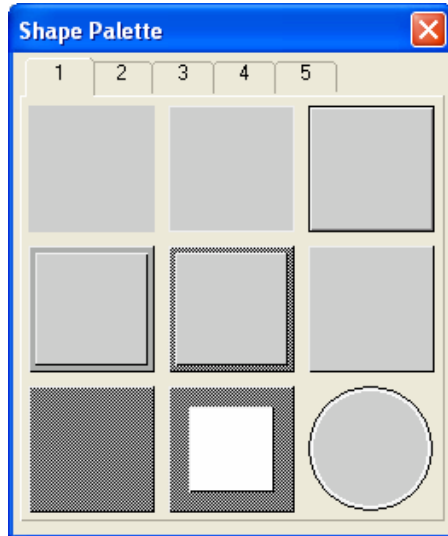

Graphical shapes for data entry objects

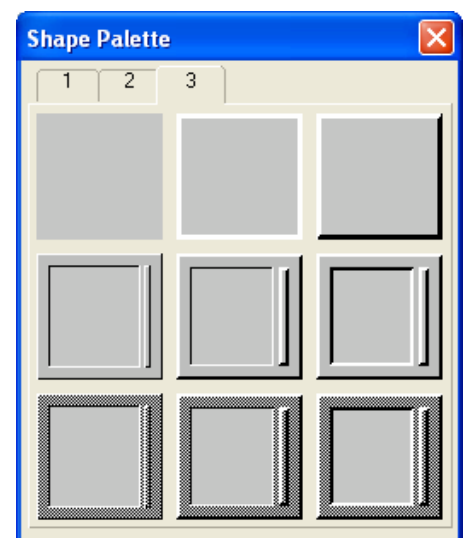
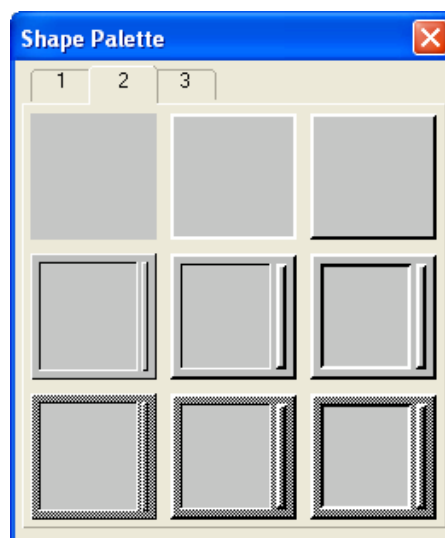
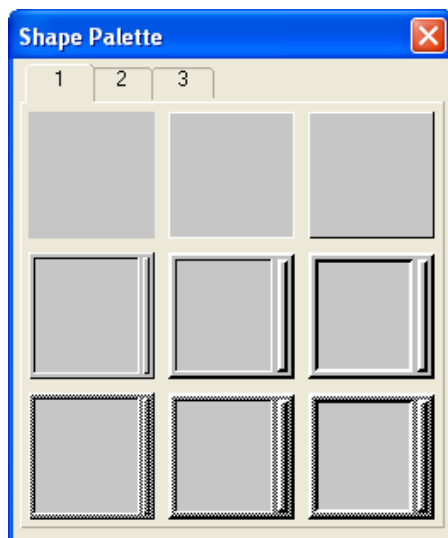

Graphical shapes for data display objects

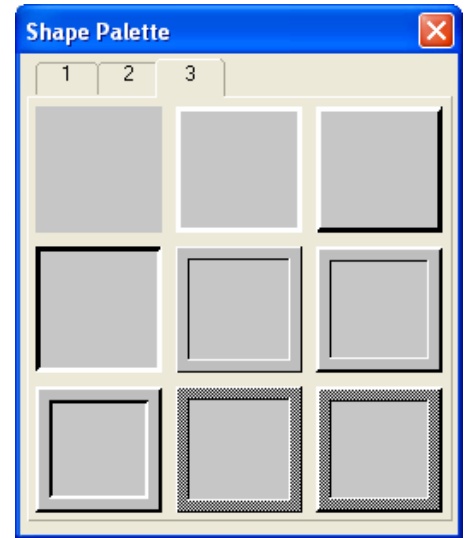
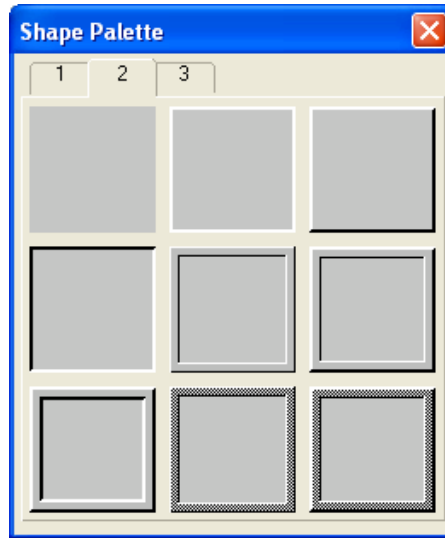
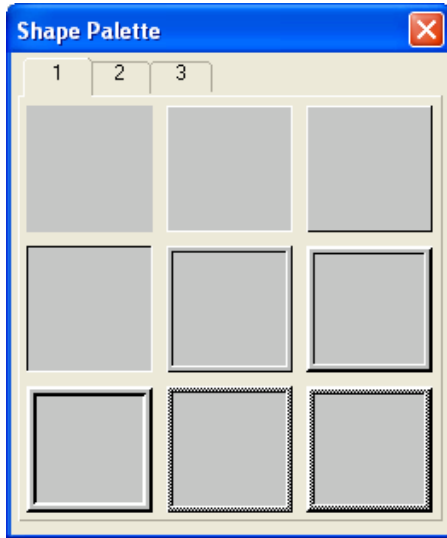

Graphical shapes for lamps

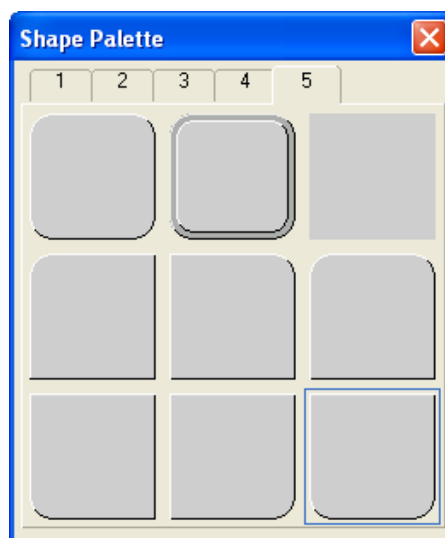
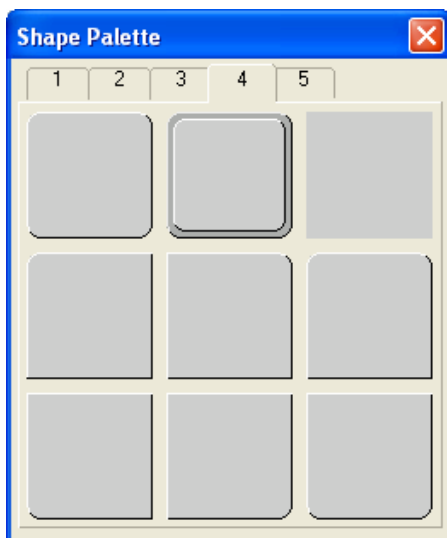
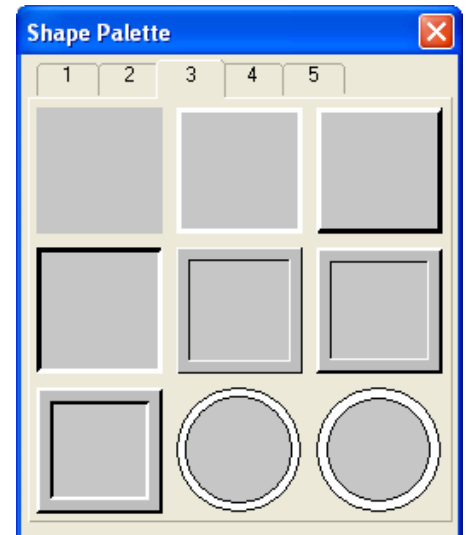
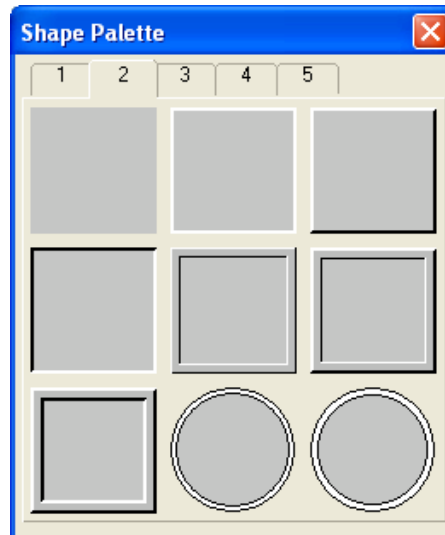
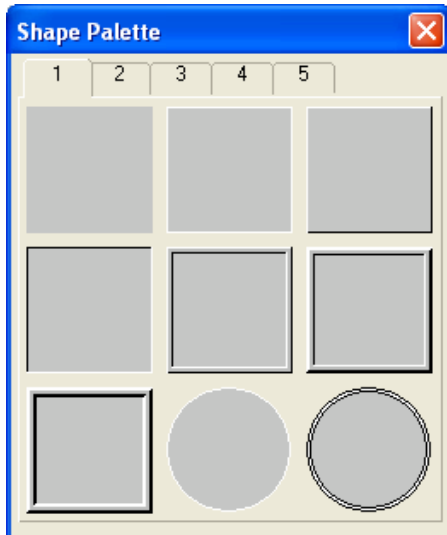

4.3.4. Setting up the Shape of an Object





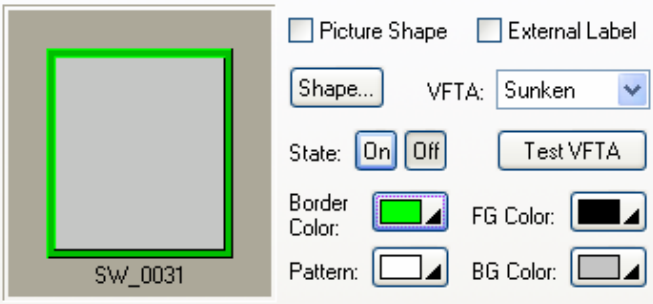
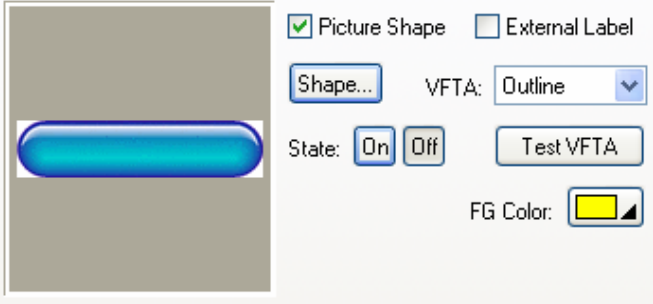

This section describes how to set the shape of an object.

In order to give the operator visual feedback for the touch action, most of the graphical shapes designed for touch operable objects can change their look when touched. The edge or border can look pressed or the outline can be shown with a different color.

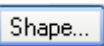
The following examples are the shape settings of a bit button:

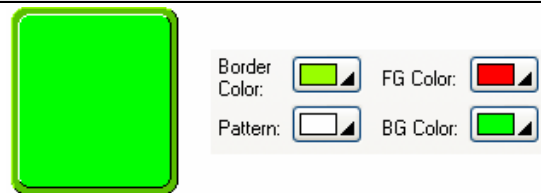
Example 1	Example 2
The graphical shape SW_0031 is selected.	The graphical shape is a picture.
	

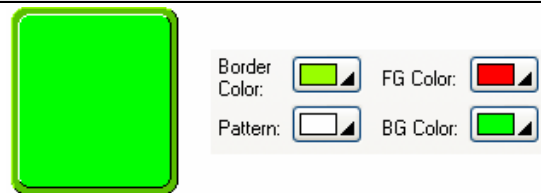
The following table describes each property that may be required for the settings of an object's shape.

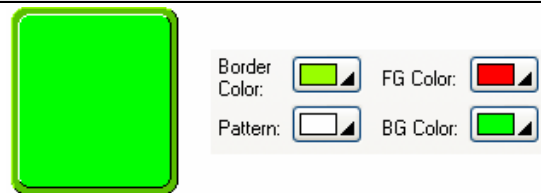
Property	Description				
Picture Shape	Check this option if you want the object to have a picture shape instead of a graphical shape. This option is available when the object can have a picture shape.				
	Click this button to specify the shape of the object. When Picture Shape is checked, the Select/Import from Library dialog box will display. Otherwise, the Shape palette will display.				
VFTA	The type of VFTA (Visual Feedback for Touch Action).				
Test VFTA	Click this button to view the selected VFTA.				
Border Color	The border color of the graphical shape. Click the corresponding Color icon to specify the color.				
Pattern	The pattern that is used to fill the area inside the border of the graphical shape for the current (object) state. To specify the pattern, click the corresponding Pattern icon and select a pattern from the Pattern palette. This item is available when the area inside the graphical shape needs be painted.				
FG Color	The color that is used to paint the black part of the pattern for the current (object) state. When the solid white pattern is selected, this color is not used. When a picture shape is used, this color is used for the outline mode with VFTA. <table border="1" data-bbox="303 1556 1492 1803"> <thead> <tr> <th>Example 1</th> <th>Example 2</th> </tr> </thead> <tbody> <tr> <td>  </td> <td>  </td> </tr> </tbody> </table>	Example 1	Example 2		
Example 1	Example 2				
					
BG Color	The color that is used to paint the white part of the pattern for the current object state. To specify the color, click the corresponding Color icon and select a color from the Color palette. This item is available when the area inside the graphical shape needs be painted.				

4.3.5. Label Settings

This section describes how to set up the inner label for the following types of objects:

Bit Button, Toggle Switch, Screen Button, Function Button, Word Button, Keypad Button, and Bit Lamp.

The property sheets of the above mentioned objects provide you with the Label page to set up the inner label. If an object only has one state, the Label page has the Text sub-page and the Picture sub-page for you to set up the text and the picture of the inner label respectively. If an object has two states, the Label page has the following four sub-pages:

Sub-page	For Setting
OFF Text	Text of state 0 (Off)
OFF Picture	Picture of state 0 (Off)
ON Text	Text of state 1 (On)
ON Picture	Picture of state 1 (On)

You can use the Label page to set the inner label of an object that can have at most two states.

The following is an example of the Label page.

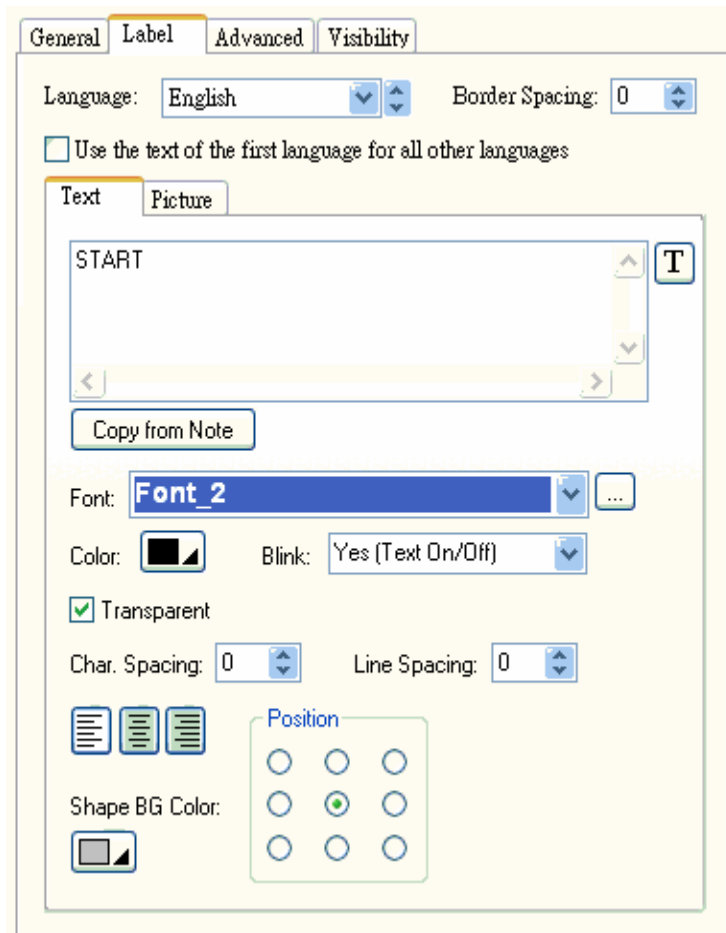

The following table describes only the properties in the Label page that are common to all its sub-pages. The properties of each of its sub-pages are described in the specific section about each sub-page.

Property	Description
Language	The language that you are setting the text for.
Border Spacing	The margin (in pixels) to the border of the object's shape for both the text body and picture.
Use the text of the first language for all other languages	Check this item so the inner label always shows the text of the first language regardless of what the current language is.
Text tab	Click this tab to bring up the Text sub-page.
Picture tab	Click this tab to bring up the Picture sub-page.
OFF Text tab	Click this tab to bring up the OFF Text sub-page.
ON Text tab	Click this tab to bring up the ON Text sub-page.
OFF Picture tab	Click this tab to bring up the OFF Picture sub-page.
ON Picture tab	Click this tab to bring up the ON Picture sub-page.

4.3.5.1. Text Sub-page Settings

You can use the Text sub-page, OFF Text sub-page, and ON Text sub-page to set up the text of the inner label for each of the corresponding states, as well as the current language. The language being set is specified by the Language item in the Label page.

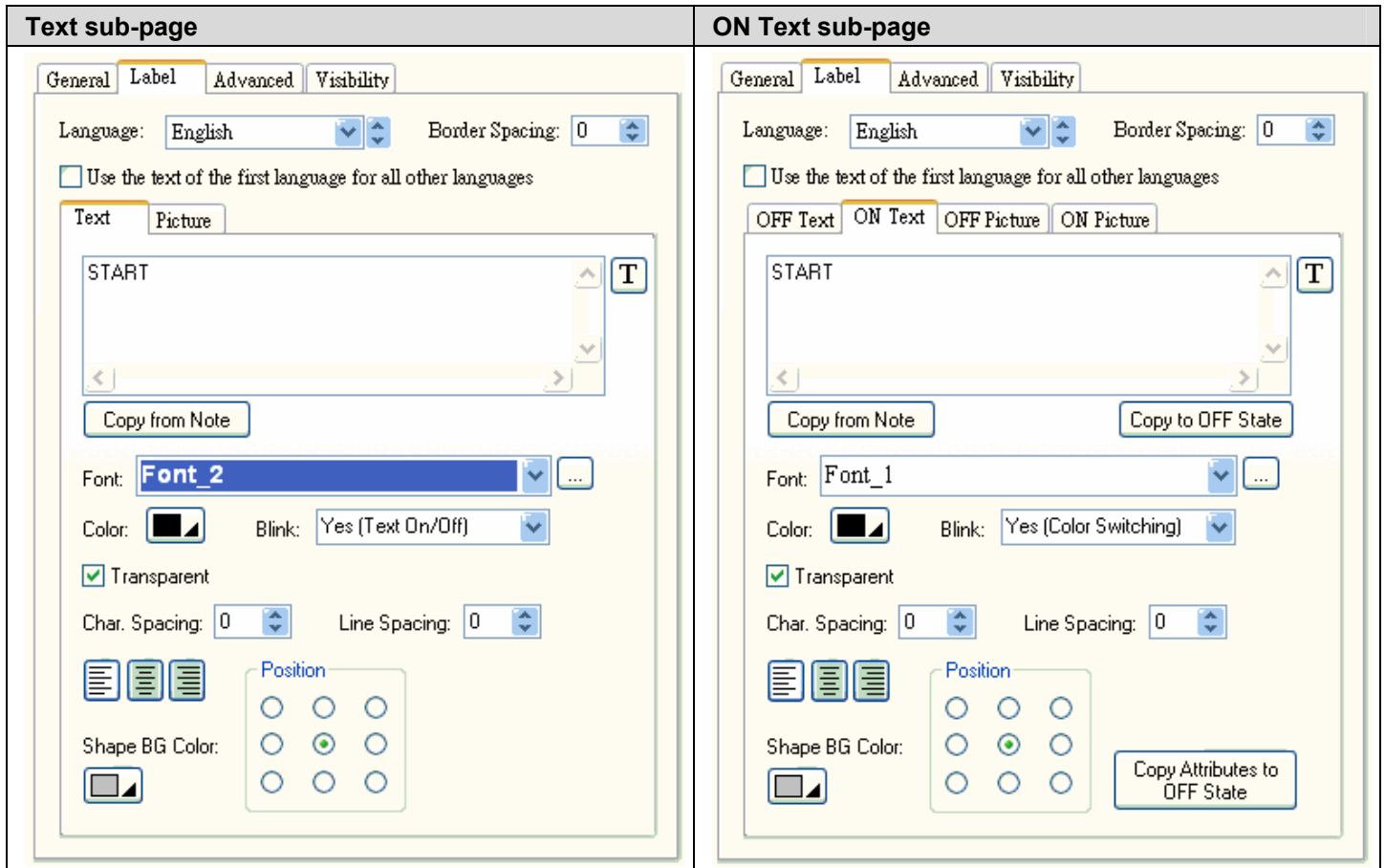

The following are examples of the Text pages:



The following table describes each property in the Text sub-page, OFF Text sub-page, and ON Text sub-page.

Property	Description
Copy from Note	Click this button to replace the current text by the text of Note in the General page.
Copy to ON State	Click this button to use the current text to replace the text of ON state.
Copy to OFF State	Click this button to use the current text to replace the text of OFF state.
Font	The font of the text. You can use the drop-down list to select a font. Click  to bring up the Font Templates dialog box and select a font for the text. You can change the font templates before selecting a font in that dialog box.
Color	The color of the text. To specify the color, click the corresponding Color icon and select a color from the Color palette.
Blink	Check this item so the text will blink. You have blink effects to choose from. Color switching changes the color of the text from its original color to the color of the background. Text On/Off displays and hides the text.
Transparent	Check this item to make the background of the characters transparent.
BG Color	The background color of the text.

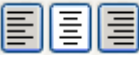
Continued

Property	Description
Line Spacing	The distance (in pixels) between two adjacent lines of the text.
Character Spacing	The distance (in pixels) between two adjacent characters of the text.
	The alignment of the text.
Position 	The position of the text body.
Shape BG Color	The BG color of the object's shape for the current state.
Copy Attributes to ON State	Click this button to use the current attributes to replace the text of ON state.
Copy Attributes to OFF State	Click this button to use the current attributes to replace the text of OFF state.



4.3.5.2. Picture Sub-page Settings

You can use the Picture sub-page, OFF Picture sub-page, and ON Picture sub-page to set up the picture of the inner label for the corresponding states.

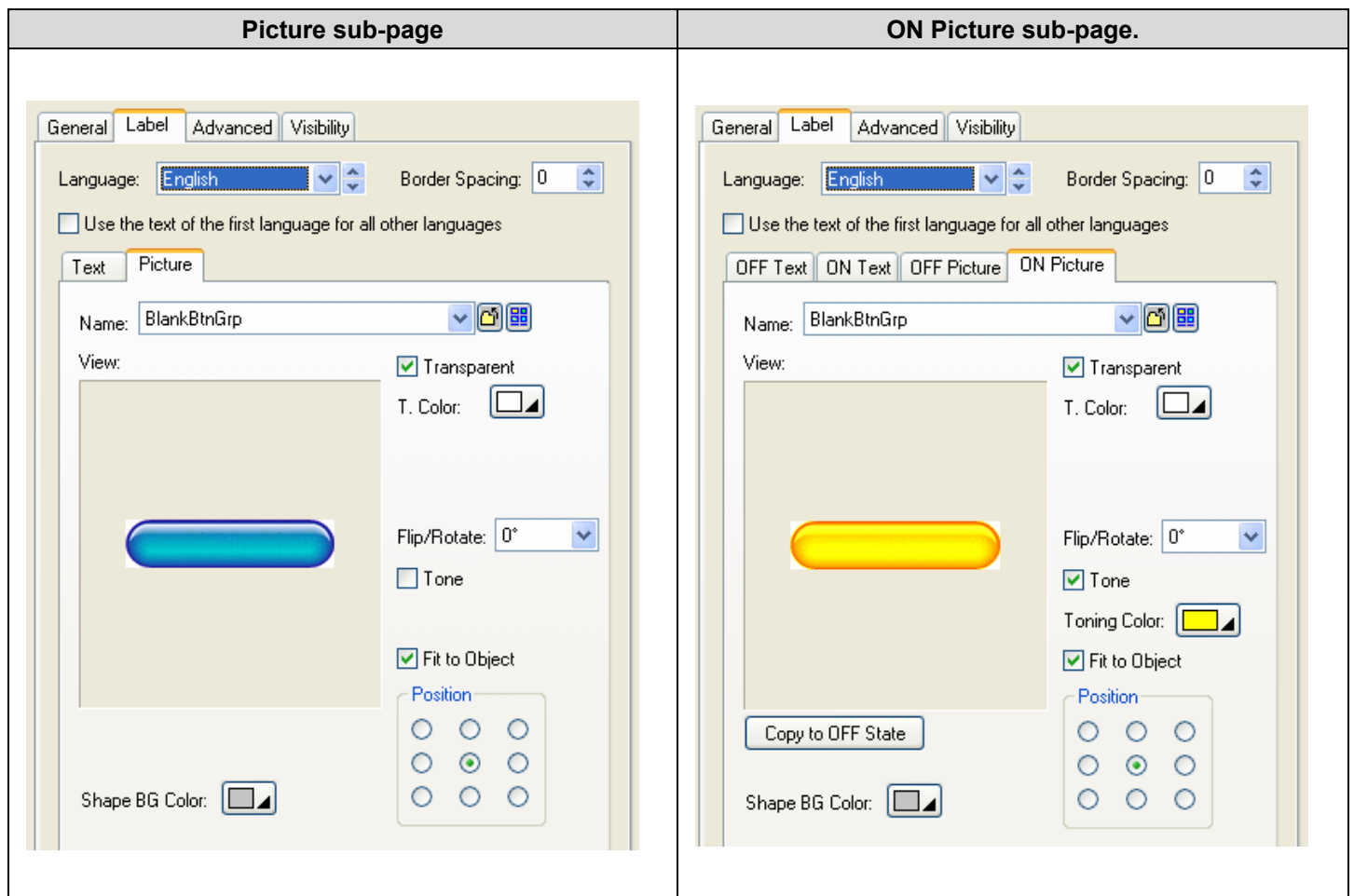
The following are examples of the Picture pages:



The following table describes each property in the Picture sub-page, OFF Picture sub-page, and ON Picture sub-page.

Property	Description																		
Name	The name of the picture. You can use the drop-down list to select a picture from the picture database. Click  to select a picture file. After the selection, the picture of the selected file is imported and saved in the picture database. Click  to bring up the Select/Import from Library dialog box. Select a picture from a picture library file. After the selection, the selected picture is imported and saved in the picture database.																		
Copy to OFF State	Click this button to use the current picture to replace the picture of OFF state.																		
Copy to ON State	Click this button to use the current picture to replace the picture of ON state.																		
Transparent	Check this item to make parts of the picture transparent. The transparent parts are pixels whose colors are the same as the specified transparent color. This item is available when the picture is not a black and white picture.																		
T. Color	The transparent color.																		
FG Color	The color to paint the black part of a black and white picture. This item is available when the picture is a black and white picture.																		
BG Color	The color to paint the white part of a black and white picture. This item is available when the picture is a black and white picture.																		
Flip/Rotate	Specifies the method to flip or rotate the picture before drawing it. There are 8 options: <table border="1" data-bbox="300 958 1257 1406"> <thead> <tr> <th>Method</th> <th>Description</th> </tr> </thead> <tbody> <tr> <td>0°</td> <td>No rotation</td> </tr> <tr> <td>90°</td> <td>Rotates the picture clockwise by 90 degrees</td> </tr> <tr> <td>180°</td> <td>Rotates the picture clockwise by 180 degrees</td> </tr> <tr> <td>270°</td> <td>Rotates the picture clockwise by 270 degrees</td> </tr> <tr> <td>X</td> <td>Flips the picture over the X axis</td> </tr> <tr> <td>90° & X</td> <td>Rotates the picture clockwise by 90 degrees and flips it over the X Axis</td> </tr> <tr> <td>Y</td> <td>Flips the picture over the Y axis</td> </tr> <tr> <td>90° & Y</td> <td>Rotates the picture clockwise by 90 degrees and flips it over the Y Axis</td> </tr> </tbody> </table>	Method	Description	0°	No rotation	90°	Rotates the picture clockwise by 90 degrees	180°	Rotates the picture clockwise by 180 degrees	270°	Rotates the picture clockwise by 270 degrees	X	Flips the picture over the X axis	90° & X	Rotates the picture clockwise by 90 degrees and flips it over the X Axis	Y	Flips the picture over the Y axis	90° & Y	Rotates the picture clockwise by 90 degrees and flips it over the Y Axis
Method	Description																		
0°	No rotation																		
90°	Rotates the picture clockwise by 90 degrees																		
180°	Rotates the picture clockwise by 180 degrees																		
270°	Rotates the picture clockwise by 270 degrees																		
X	Flips the picture over the X axis																		
90° & X	Rotates the picture clockwise by 90 degrees and flips it over the X Axis																		
Y	Flips the picture over the Y axis																		
90° & Y	Rotates the picture clockwise by 90 degrees and flips it over the Y Axis																		
Tone	Check this item to tone the picture.																		
Toning Color	The color to tone the picture.																		
Fit to Object	Check this item so the picture can change its size automatically to fit inside the border of the object's shape.																		
Position	 <p>The position of the picture within the object.</p>																		
Shape BG Color	The BG color of the object's shape for the current state.																		

4.3.6. Text Settings

This section describes how to set up the text of the inner label for the following types of objects:

Multi-state Switch, Radio Button Group, Step Button, Page Selector, Multi-state Lamp, Message Display, and Day-of-week Display.

The property sheets of the above mentioned objects provide you with the Text page to set up the text of the inner label. The following is an example of the Text page.

The screenshot shows the 'Text' property sheet with the following elements:

- Language:** English
- Border Spacing:** 0
- Use the text of the first language for all other languages
- State List:**

S#	Text
0	Printing screen...Please wait
1	Failed to print screen.
2	Invalid file name
3	Failed to open file.
4	Failed to delete file
5	Failed to rename file
- Attribute:**
 - Copy from state 0
 - Font: Font_1
 - Color: [Color Picker]
 - Transparent
 - BG Color: [Color Picker]
- Position:** [3x3 Grid]
- Blink:** Yes (Color Switching)
- Shape BG Color:** [Color Picker]
- Buttons:** Move Up, Move Down
- Text Area:** Failed to open file. [T icon]
- Line Spacing:** 0
- Char. Spacing:** 0







Callout 1: You can view the texts and the picture names of all the states here. You can select a state from the list. The text of the selected state becomes the current text.

Callout 2: The text of the current state and language. You can view and edit the current text here.

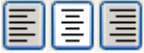
The following table describes each property in the Text page.

Property	Description
Language	The language that you are setting the text to.
Border Spacing	The margin (in pixels) of the border for the text body to the object's shape.
Use the text of the first language for all other languages	Check this item so the inner label always shows the text of the first language regardless of what the current language is.
<State list>	Lists all states and the corresponding texts. To view and modify the state attribute and its text, click the row of that state.
Move Up	Click this button to move the current text (and picture) up the list, and thus the associated state number of the current text (and picture) is decreased by one.
Move Down	Click this button to move the current text (and picture) down the list, and thus the associated state number of the current text (and picture) is increased by one.

Continued

Property	Description	
Copy to all states...	Click this button to use the text of state 0 to replace the text of all other states.	
Copy from state 0...	Click this button to use the text of state 0 to replace the current text.	
Font	The font of the current text. You can use the drop-down list to select a font. Click  to bring up the Font Templates dialog box and select a font for the current text. You can change the font templates before selecting a font from the dialog box.	
Color	The color of the current text. To specify the color, click the corresponding Color icon and select a color from the Color palette.	
Transparent	Check this item to make the text's background transparent.	
BG Color	The background color of the text.	
	The alignment of the text.	
Position 	The position of the text body.	
Blink	Select blink effects to make the text blink. Color switching changes the color of the text from its original color to the color of the background. Text On/Off displays and hides the text.	
Shape BG Color	The BG color of the object's shape for the current state.	
Text	<Edit Box> / <Combo Box>	The text for the selected state in current language.
	 / 	Click  to view and edit the text for the selected language in this edit box, or click  to select a text from dropdown text table that lists all the texts from Text Database. You can change the text database before selecting a text.
Line Spacing	The distance (in pixels) between two adjacent lines of the text.	
Character Spacing	The distance (in pixels) between two adjacent characters of the text.	

4.3.7. Picture Settings

This section describes how to define the picture settings for the following types of objects:

Multi-state Switch, Radio Button Group, Step Button, Page Selector, Multi-state Lamp, Picture Display, and Animated Graphic.

The property sheets of the above mentioned objects provide you the Picture page to define the picture settings of the objects. The following is an example of the Picture page.

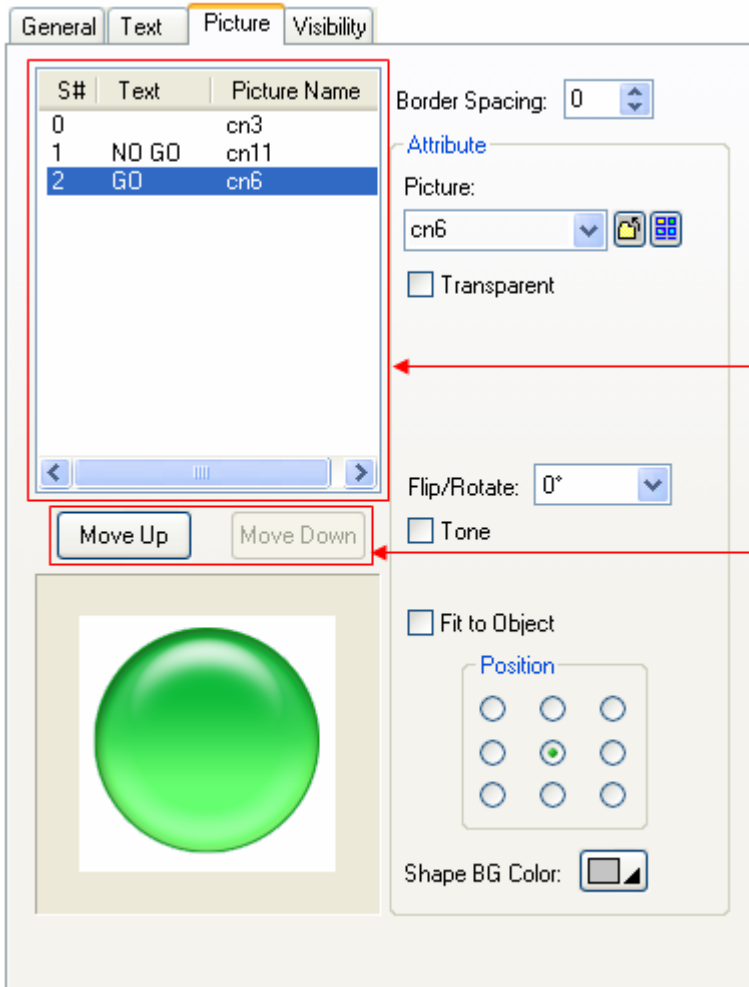



You can view the picture names and the texts of all the states here. You can select a state from the list. The picture of the selected state becomes the current picture.

Click [Move Up] to move the current picture (and text) up in the list and thus the associated state number of the current picture (and text) is decreased by one.

Click [Move Down] to move the current picture (and text) down in the list and thus the associated state number of the current picture (and text) is increased by one.

The following table describes each property in the Picture page.

Property	Description
Picture	<p>The name of the current picture. You can use the drop-down list to select a picture from the picture database.</p> <p>Click  to select a picture from a file as the current picture. After the selection, the software imports the picture of the selected file and saves the picture in the picture database.</p> <p>Click  to bring up the Select/Import from Library dialog box. Select a picture from a picture library file as the current picture. After the selection, the software imports the selected picture from the selected library and saves the picture in the picture database.</p>

Continued

Property	Description																		
Transparent	Check this item to make parts of the current picture transparent. The transparent parts are pixels whose colors are identical to the specified transparent color. This item is available when the current picture is not a black and white picture.																		
Transparent Color	The transparent color.																		
FG Color	The color to paint the black part of a black and white picture. This item is available when the current picture is a black and white picture.																		
BG Color	The color to paint the white part of a black and white picture. This item is available when the current picture is a black and white picture.																		
Flip/Rotate	Specifies the method to flip or rotate the current picture before drawing it. There are 8 options: <table border="1" data-bbox="304 584 1294 1025"> <thead> <tr> <th>Method</th> <th>Description</th> </tr> </thead> <tbody> <tr> <td>0°</td> <td>No rotation</td> </tr> <tr> <td>90°</td> <td>Rotates the picture clockwise by 90 degrees</td> </tr> <tr> <td>180°</td> <td>Rotates the picture clockwise by 180 degrees</td> </tr> <tr> <td>270°</td> <td>Rotates the picture clockwise by 270 degrees</td> </tr> <tr> <td>X</td> <td>Flips the picture over the X axis</td> </tr> <tr> <td>90° & X</td> <td>Rotates the picture clockwise by 90 degrees and flips it over the X Axis</td> </tr> <tr> <td>Y</td> <td>Flips the picture over the Y axis</td> </tr> <tr> <td>90° & Y</td> <td>Rotates the picture clockwise by 90 degrees and flips it over the Y Axis</td> </tr> </tbody> </table>	Method	Description	0°	No rotation	90°	Rotates the picture clockwise by 90 degrees	180°	Rotates the picture clockwise by 180 degrees	270°	Rotates the picture clockwise by 270 degrees	X	Flips the picture over the X axis	90° & X	Rotates the picture clockwise by 90 degrees and flips it over the X Axis	Y	Flips the picture over the Y axis	90° & Y	Rotates the picture clockwise by 90 degrees and flips it over the Y Axis
Method	Description																		
0°	No rotation																		
90°	Rotates the picture clockwise by 90 degrees																		
180°	Rotates the picture clockwise by 180 degrees																		
270°	Rotates the picture clockwise by 270 degrees																		
X	Flips the picture over the X axis																		
90° & X	Rotates the picture clockwise by 90 degrees and flips it over the X Axis																		
Y	Flips the picture over the Y axis																		
90° & Y	Rotates the picture clockwise by 90 degrees and flips it over the Y Axis																		
Tone	Check this item to tone the current picture.																		
Toning Color	The color to tone the current picture.																		
Fit to Object	Check this item so the current picture can change its size automatically to fit inside the border of the object's shape.																		
Position 	The position of the current picture within the object.																		
Shape BG Color	The BG color of the object's shape for the current state.																		

4.3.8. External Label Settings

This section describes how to set up the external label for the following types of objects:

Bit Button, Toggle Switch, Screen Button, Slide Switch, Word Button, Multi-state Switch, Radio Button Group, Step Button, Numeric Entry, Numeric Display, Advanced Numeric Display, ASCII String Entry, ASCII String Display, Bit Lamp, Multi-state Lamp, Message Display, Picture Display, and Bar Graph.



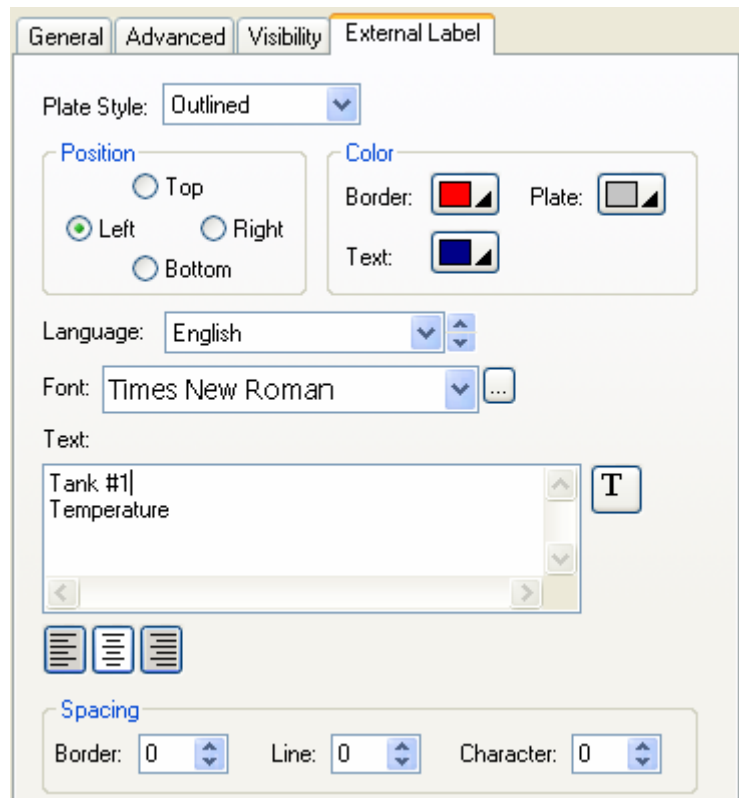









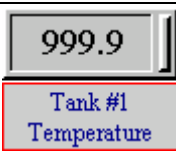

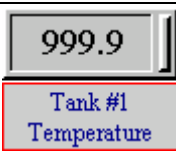

You can use the External Label page of an object's property sheet to set up the external label of that object. The following is an example of the External Label page.

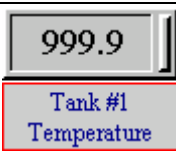

The following table describes each property in the External Label page.

Property	Description										
Plate Style	Specifies the plate type of the external label. There are four plate types as shown below:										
	<table border="1"> <thead> <tr> <th>Plate Type</th> <th>Example</th> </tr> </thead> <tbody> <tr> <td>Transparent,</td> <td>Tank #1 Temperature </td> </tr> <tr> <td>Flat,</td> <td>Tank #1 Temperature </td> </tr> <tr> <td>Outlined</td> <td>Tank #1 Temperature </td> </tr> <tr> <td>Raised</td> <td>Tank #1 Temperature </td> </tr> </tbody> </table>	Plate Type	Example	Transparent,	Tank #1 Temperature	Flat,	Tank #1 Temperature	Outlined	Tank #1 Temperature	Raised	Tank #1 Temperature
	Plate Type	Example									
	Transparent,	Tank #1 Temperature									
	Flat,	Tank #1 Temperature									
Outlined	Tank #1 Temperature										
Raised	Tank #1 Temperature										

Continued

Property		Description										
Position		<p>Specifies the position of the external label relative to the object. There are four positions as shown below:</p> <table border="1"> <thead> <tr> <th>Position</th> <th>Example</th> </tr> </thead> <tbody> <tr> <td>Top</td> <td>  </td> </tr> <tr> <td>Left</td> <td>  </td> </tr> <tr> <td>Right</td> <td>  </td> </tr> <tr> <td>Bottom</td> <td>  </td> </tr> </tbody> </table>	Position	Example	Top		Left		Right		Bottom	
Position	Example											
Top												
Left												
Right												
Bottom												
Color	Border	The border color of the plate. To specify the color, click the corresponding Color icon and select a color from the Color palette.										
	Plate	The color of the plate. To specify the color, click the corresponding Color icon and select a color from the Color palette.										
	Text	The color of the text. To specify the color, click the corresponding Color icon and select a color from the Color palette.										
Language		The language that you are setting the text to.										
Font	<Drop-down List>	The font of the text for the current language										
		Click this button to bring up the Font Templates dialog box and select a font for the text. You can change the font templates before selecting a font in that dialog box.										
Text	<Edit Box> / <Combo Box>	The text for the current language.										
	 / 	Click  to view and edit the text for the selected language in this edit box, or click  to select a text from dropdown text table that lists all the texts from Text Database. You can change the text database before selecting a text.										
		The alignment of the text.										
Spacing	Border	The distance (in pixels) between the plate border and the text body.										
	Line	The distance (in pixels) between two adjacent lines of the text.										
	Character	The distance (in pixels) between two adjacent characters of the text.										

4.4. Setting up Objects

4.4.1. States of Objects

When an object has multiple states, its appearance automatically has the same number of corresponding states. You need to specify the settings of the shape and the inner label of an object for each state. Usually the state of an object is determined by the value of the variable it monitors. An object that monitors a bit has state 0 (off) and state 1 (on). An object that monitors a word or a double-word can have up to 256 states.

4.4.1.1. State Types

You need to specify the state type of an object so the object knows how to determine its state. The following table describes each of the four state types.

State Type	For	How to decide the state
Bit	Bit Variable	The state is the value of the variable. Example: 1)The state of \$U1.3 is 0 when \$U1.3 is 0 (off). 2)The state of WX3.f is 1 when WX3.f is 1 (on).
Value	Word Variable, Double-word Variable	The state is the value of the variable. The valid states are from 0 to 255. Example: 1)The state of \$U200 is 123 when \$U200 is 123. 2)The state of WX20 is 0 when WX20 is 0. 3)The state of \$N300 is invalid when \$N300 is 999.
LSB	Word Variable, Double-word Variable	The state is the number of the least significant bit of the variable's value that is 1 (on). For a word variable, the valid state are from 0 to 16 and state 16 means all the bits are 0. For a double-word variable, the valid state are from 0 to 32 and state 32 means all the bits are 0. Example: 1)The state of \$U200 is 1 when \$U200 is 246H. 2)The state of WX20 is 19 when WX20 is 80000H. 3)The state of \$N300 is 16 when \$N300 is 0.
Custom	Word Variable, Double-word Variable	When you configure an object with the Custom state type, you assign each valid state a unique number which is called a state value. The assigned state values will be used to determine the state of the object. If the variable's value is equal to one of the state values, the corresponding state of the state value is the state of the object. If the value is equal to none of the state values, the state is invalid. Example: An object monitors \$U100 and its state type is Custom. There are three valid states and you assigned 300, 200, and 100 to state 0, 1, and 2 respectively. The state is 2 when \$U100 is 100 and the state is 0 when \$U100 is 300.

4.4.1.2. Setting the Custom States of an Object

In the General page of the object's property dialog box, with the Custom state type selected, click the Custom State Value... button to bring up the Custom State Value dialog box as the example shown below.

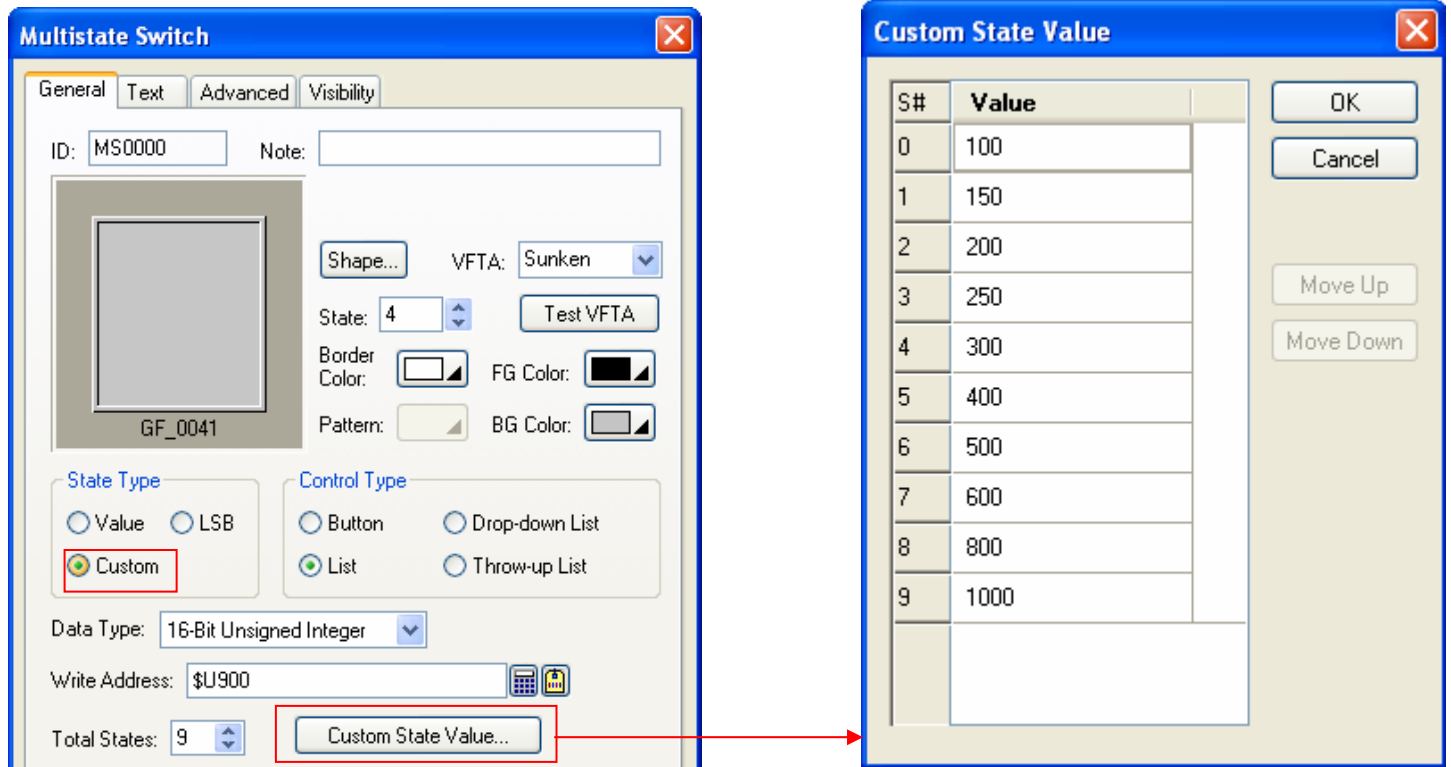

You can assign a positive integer for each state in the dialog box. To edit the value, click the row of that state under the value column.

You can use the Move Up button and the Move Down button to adjust the position of state values. To move up or move down the state values, you need to make a selection first. To select a state, click the header column. To select multiple rows, click the header column and use Ctrl+Click to add a row to the selection.

4.4.2. Operation Options of Objects

The following table explains operation options which can be added to an object to make it more informative, secure, and useful.

Terminology	Definition
Enabling and disabling the touch operation	<p>The touch operation can be enabled and disabled either by a specified bit or by the current user level. You can choose to display the touch operation disabled sign on the button when the touch operation is disabled.</p> <p>If the touch operation is to be enabled by a bit, you need to specify that bit and the bit value that enables the touch operation.</p> <p>If the touch operation is to be enabled by the current user level, you need to specify the lowest user level that is required to enable the touch operation.</p> <p>Select and set this feature in the Advanced page of the Bit Button dialog box.</p>
Requiring the minimum hold time	<p>The touch operation will not be activated until the button is pressed and held down for the specified Minimum Hold Time.</p> <p>Select and set this feature in the Advanced page of the Bit Button dialog box.</p>
Requiring the operator confirmation	<p>A confirmation dialog box is displayed when the button is activated for setting a bit. The button will proceed to set that bit if the operator selects “Yes” to confirm the operation. The touch operation will be cancelled if the operator selects “No” to reject the operation or if the operator does not respond within the Maximum Waiting Time.</p> <p>This feature is available for the following operations: Set ON, Set OFF, Set ON Pulse, Set OFF Pulse, and Invert.</p> <p>Select and set this feature in the Advanced page of the Bit Button dialog box.</p>
Notifying a bit of the touch operation	<p>The notification is performed after the touch operation is done. You need to specify the bit to be notified and the bit value to be used for the notification.</p> <p>Select and set this feature in the Advanced page of the Bit Button dialog box.</p>
Logging the touch operations	<p>The time and date when the touch operation occurs, the new value that is written to the bit, and the predefined text can be recorded in the operation log with this feature.</p> <p>Select and set this feature in the Advanced page of the Bit Button dialog box.</p>
Showing and hiding an object	<p>The visibility of an object can be controlled either by a specified bit or by the current user level, i.e. an object can be shown and hidden dynamically by any of these two methods.</p> <p>If visibility is to be controlled by a bit, you need to specify that bit and the bit value that shows the object.</p> <p>If visibility is to be controlled by the current user level, you need to specify the lowest user level that is required to show the visibility.</p> <p>Note 1: When an object is invisible, the touch operation is automatically disabled. Note 2: It is allowed to simply set an object as invisible. The touch operation is still enabled with this setting.</p> <p>Select and set this feature on the Visibility page of the object setting dialog box.</p>

4.4.3. Address Settings

This chapter describes the terms, rules, and methods to address data.













4.4.3.1. Terminologies for Data Accessing

The following table explains variables, addresses and tags.

Terminology	Definition
Internal memory	The memory space in the target panel that can be accessed by the panel application. For example, the user memory \$U, the non-volatile memory \$N, the system memory \$S, and the recipe memory \$R are all parts of the internal memory.
Internal variable	An address or a tag referring to an address of a space in the internal memory.
Internal bit variable	An internal variable that refers to a bit in the internal memory. Note: "Internal variable" instead of "internal bit variable" is used when referring to a bit if there is no ambiguity.
Internal word variable	An internal variable that refers to a word in the internal memory. The variables can also be used to refer to a double-word, a block of bytes (byte array), a block of words (word array), and a block of double-words (double-word array). Note: "Internal variable" instead of "internal bit variable" is used when referring to a bit if there is no ambiguity.
External memory	The memory spaces or the collections of addressable devices in the controllers that can be accessed by the panel application through communication links.
External variable	An address or a tag referring to an address of a space in the external memory.
External bit variable	An external variable that refers to a bit in the external memory. Note: "External variable" instead of "external bit variable" is used when referring to a bit if there is no ambiguity.
External word variable	An external variable that refers to a word in the external memory. The variables can also be used to refer to a double-word, a block of bytes (byte array), a block of words (word array), and a block of double-words (double-word array) if the access unit of the associated addresses is word. If the access unit is double-word, you can only use the variable to refer to a double-word or a block of memory space with a length of a multiple of 4 (bytes). Note: "External variable" instead of "external bit variable" is used when referring to a bit if there is no ambiguity.
Variable	An internal variable or an external variable.
Bit variable	An internal bit variable or an external bit variable.
Word variable	An internal word variable or an external word variable.
Double-word variable	An internal variable or an external variable that refers to a double-word.
Byte array variable	An internal variable or an external variable that refers to a byte array.
Word array variable	An internal variable or an external variable that refers to a word array.
Double-word array variable	An internal variable or an external variable that refers to a double-word array.
Tag	A name that stands for an address of the internal memory or the external memory. It also specifies the data type and scan rate of the data in the memory location it refers to.

4.4.3.2. Address Input Keypad

With the address input keypad, you can enter an address easily. Usually, you click  to bring up the address input keypad as shown below.

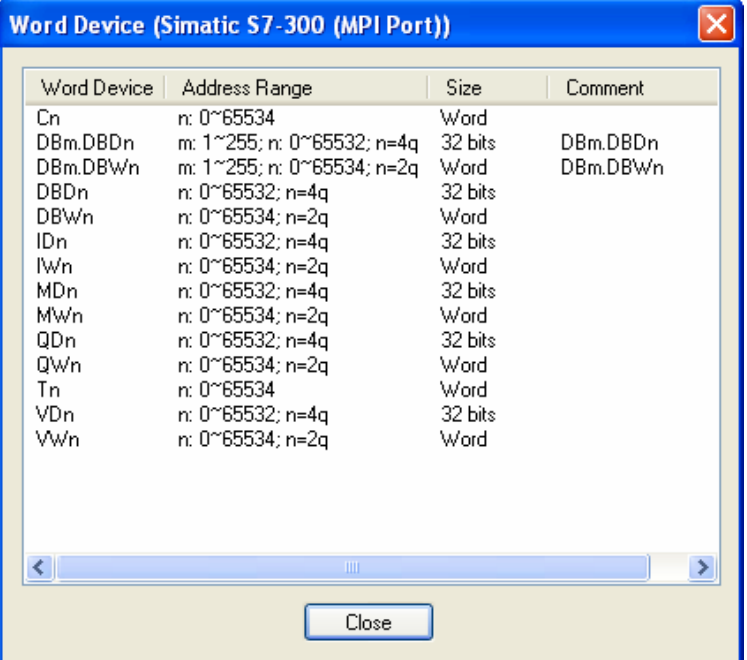
Property	Description																																																												
Link	Click the down arrow and select a link from the drop down list.																																																												
PLC Address	Click the down arrow and select a value between 0 and 255 or an indirect address between [\$I0] and [\$I15] as the PLC Address. If an indirect address is used, the plc address can be dynamically changed.																																																												
Location Type	Click the down arrow and select an item from the drop down list as the location type.																																																												
Address	Specify the address.																																																												
Input keypad	<table border="1"> <thead> <tr> <th>Buttons</th> <th>Description</th> </tr> </thead> <tbody> <tr> <td></td> <td>Clears all the texts in the address field.</td> </tr> <tr> <td></td> <td>Deletes all selected texts, if any, or the text character to the left of the cursor in the address field.</td> </tr> <tr> <td></td> <td>Cancel the address input and escapes the dialog.</td> </tr> <tr> <td></td> <td>Checks and enters the address if valid.</td> </tr> <tr> <td>Others</td> <td>Click to specify the address. Only available when the Address field holds the input focus.</td> </tr> </tbody> </table>	Buttons	Description		Clears all the texts in the address field.		Deletes all selected texts, if any, or the text character to the left of the cursor in the address field.		Cancel the address input and escapes the dialog.		Checks and enters the address if valid.	Others	Click to specify the address. Only available when the Address field holds the input focus.																																																
Buttons	Description																																																												
	Clears all the texts in the address field.																																																												
	Deletes all selected texts, if any, or the text character to the left of the cursor in the address field.																																																												
	Cancel the address input and escapes the dialog.																																																												
	Checks and enters the address if valid.																																																												
Others	Click to specify the address. Only available when the Address field holds the input focus.																																																												
	<p>Click the help button to see how to specify word or bit devices and their addresses for the specified link in the following pop-up dialog.</p>  <table border="1"> <thead> <tr> <th>Word Device</th> <th>Address Range</th> <th>Size</th> <th>Comment</th> </tr> </thead> <tbody> <tr> <td>Cn</td> <td>n: 0~65534</td> <td>Word</td> <td></td> </tr> <tr> <td>DBm.DBDn</td> <td>m: 1~255; n: 0~65532; n=4q</td> <td>32 bits</td> <td>DBm.DBDn</td> </tr> <tr> <td>DBm.DBWn</td> <td>m: 1~255; n: 0~65534; n=2q</td> <td>Word</td> <td>DBm.DBWn</td> </tr> <tr> <td>DBDn</td> <td>n: 0~65532; n=4q</td> <td>32 bits</td> <td></td> </tr> <tr> <td>DBWn</td> <td>n: 0~65534; n=2q</td> <td>Word</td> <td></td> </tr> <tr> <td>IDn</td> <td>n: 0~65532; n=4q</td> <td>32 bits</td> <td></td> </tr> <tr> <td>IWn</td> <td>n: 0~65534; n=2q</td> <td>Word</td> <td></td> </tr> <tr> <td>MDn</td> <td>n: 0~65532; n=4q</td> <td>32 bits</td> <td></td> </tr> <tr> <td>MWn</td> <td>n: 0~65534; n=2q</td> <td>Word</td> <td></td> </tr> <tr> <td>QDn</td> <td>n: 0~65532; n=4q</td> <td>32 bits</td> <td></td> </tr> <tr> <td>QWn</td> <td>n: 0~65534; n=2q</td> <td>Word</td> <td></td> </tr> <tr> <td>Tn</td> <td>n: 0~65534</td> <td>Word</td> <td></td> </tr> <tr> <td>VDn</td> <td>n: 0~65532; n=4q</td> <td>32 bits</td> <td></td> </tr> <tr> <td>VWn</td> <td>n: 0~65534; n=2q</td> <td>Word</td> <td></td> </tr> </tbody> </table>	Word Device	Address Range	Size	Comment	Cn	n: 0~65534	Word		DBm.DBDn	m: 1~255; n: 0~65532; n=4q	32 bits	DBm.DBDn	DBm.DBWn	m: 1~255; n: 0~65534; n=2q	Word	DBm.DBWn	DBDn	n: 0~65532; n=4q	32 bits		DBWn	n: 0~65534; n=2q	Word		IDn	n: 0~65532; n=4q	32 bits		IWn	n: 0~65534; n=2q	Word		MDn	n: 0~65532; n=4q	32 bits		MWn	n: 0~65534; n=2q	Word		QDn	n: 0~65532; n=4q	32 bits		QWn	n: 0~65534; n=2q	Word		Tn	n: 0~65534	Word		VDn	n: 0~65532; n=4q	32 bits		VWn	n: 0~65534; n=2q	Word	
Word Device	Address Range	Size	Comment																																																										
Cn	n: 0~65534	Word																																																											
DBm.DBDn	m: 1~255; n: 0~65532; n=4q	32 bits	DBm.DBDn																																																										
DBm.DBWn	m: 1~255; n: 0~65534; n=2q	Word	DBm.DBWn																																																										
DBDn	n: 0~65532; n=4q	32 bits																																																											
DBWn	n: 0~65534; n=2q	Word																																																											
IDn	n: 0~65532; n=4q	32 bits																																																											
IWn	n: 0~65534; n=2q	Word																																																											
MDn	n: 0~65532; n=4q	32 bits																																																											
MWn	n: 0~65534; n=2q	Word																																																											
QDn	n: 0~65532; n=4q	32 bits																																																											
QWn	n: 0~65534; n=2q	Word																																																											
Tn	n: 0~65534	Word																																																											
VDn	n: 0~65532; n=4q	32 bits																																																											
VWn	n: 0~65534; n=2q	Word																																																											

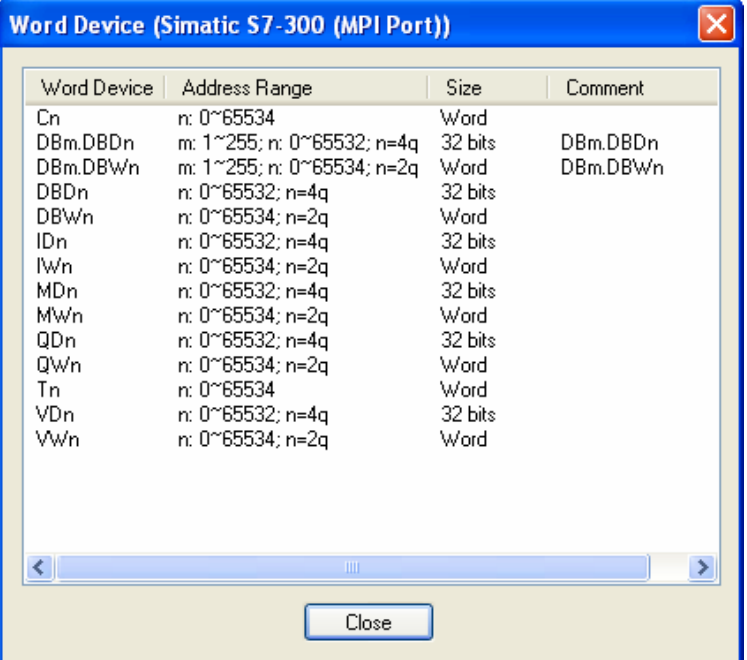
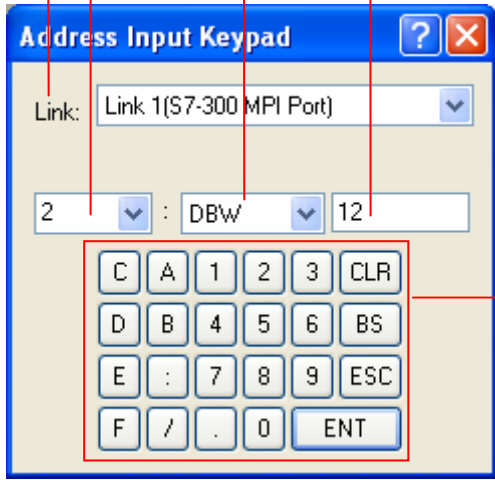

4.4.3.3. Selecting Tags

To select a tag, you can click  to bring up the Select Tag dialog box as shown below.

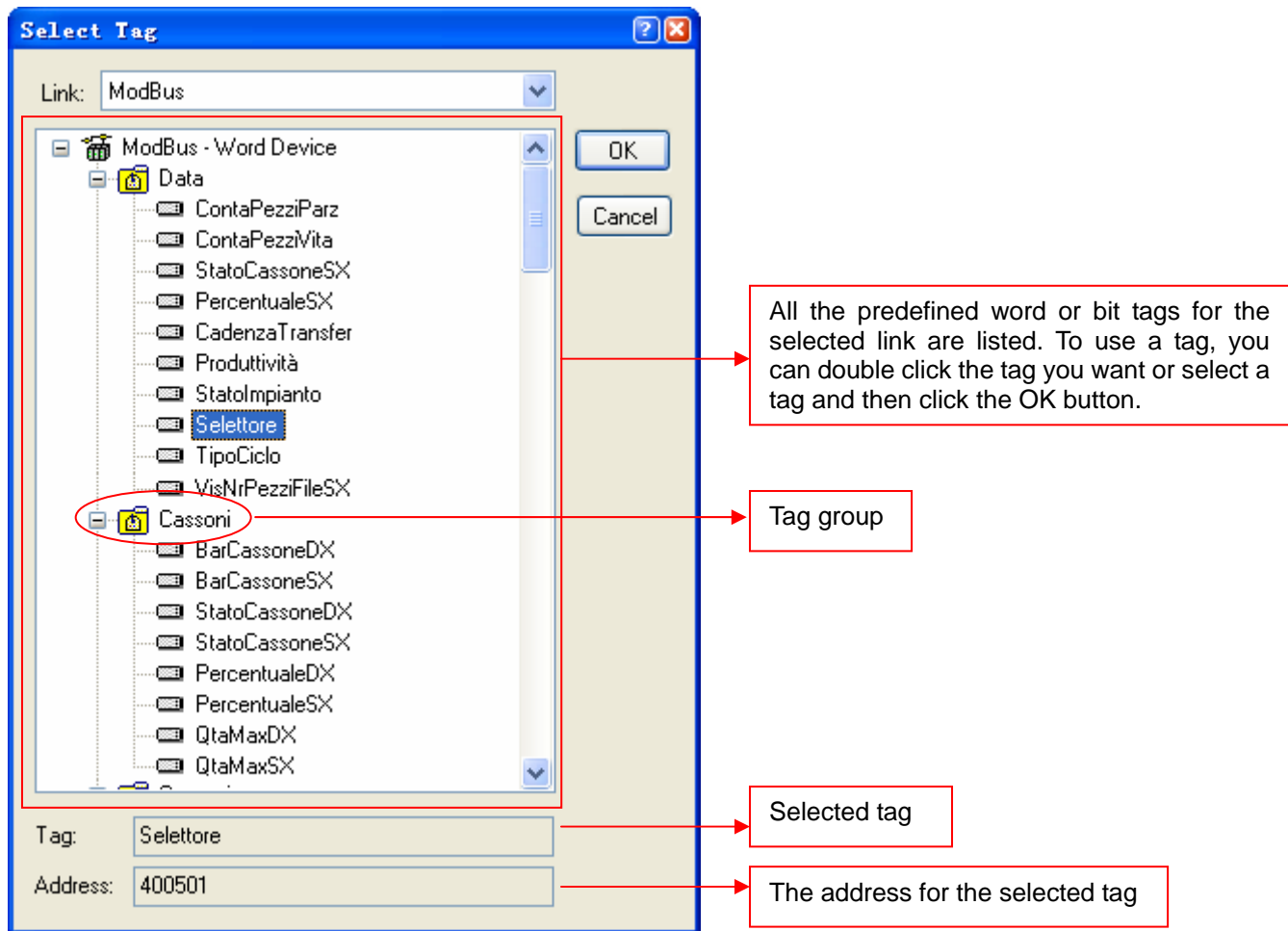

Note: All the listed tags and tag groups are created in the Tags Editor. To create a tag, please see [Section 2.3 Working with Tags](#).

4.4.4. Scale Settings

This section describes how to set up the scale for the following types of objects:

Slide Switch, Bar Graph, Circular Bar Graph, and Meter.

The following are examples of scales used in different kinds of objects.

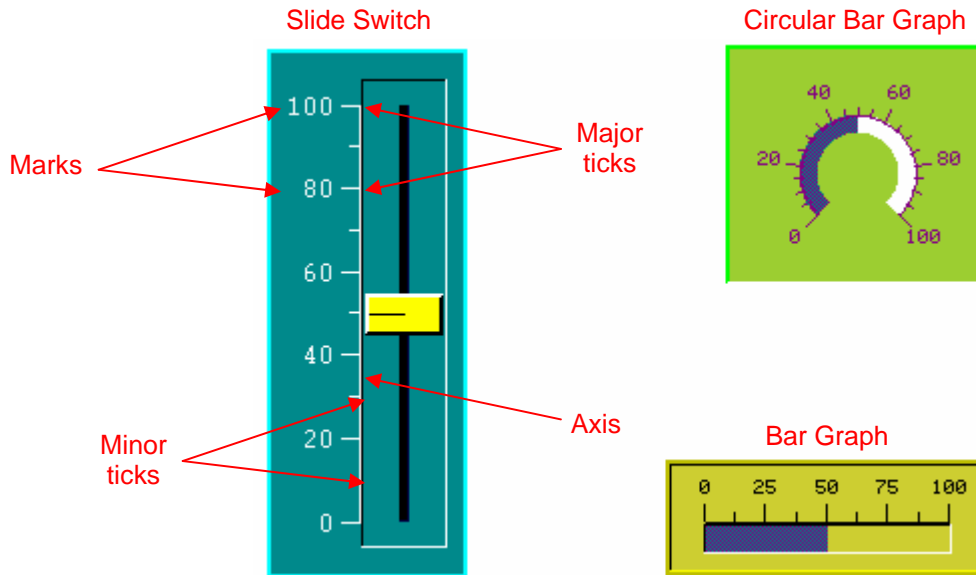

You can use the Scale page in an object's property sheet to set up the scale of that object. The following is an example of the Scale page of the bar Graph.

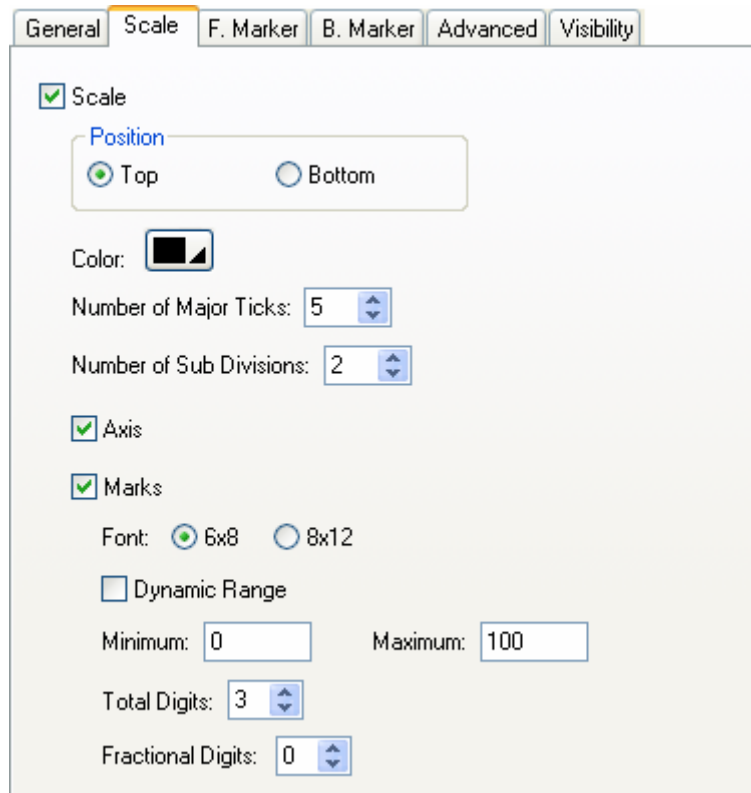

The following table describes each property in the Scale page.

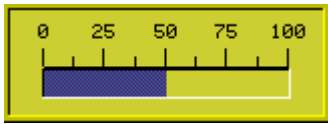
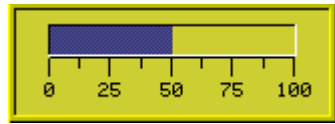
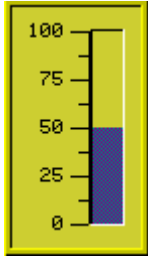
Property		Description
Scale		Check this item if you want the object to have a scale.
Position		Specifies the position of the scale in the object. The position is relative to the part of the object that displays the monitored variable. There are six positions shown below:
	Position	Example
Top		Bottom
Left		Right
Inner		Outer
Color		The color of the scale. To specify the color, click the corresponding Color icon and select a color from the Color palette.
Number of Major Ticks		The number of major ticks. The minimum you can specify is two.
Number of Sub Divisions		The number of divisions between two adjacent major ticks. The minimum you can specify is one.
Axis		Check this item if you want the scale to have an axis.
Marks	Marks	Check this option if you want the scale to have marks.
	Font	The font of the marks.
	Dynamic Range	Check this option if you want the minimum and maximum of the marks to be controlled by the dynamic range parameter block of the associated object at runtime.
	Minimum	The minimum of the marks. It is a 32-bit integer.
	Maximum	The maximum of the marks. It is a 32-bit integer.
	Total Digits	The total digits to be displayed for the marks.
	Fractional Digits	The number of fractional digits for the marks. For example, when the Maximum = 5000, the Total Digits = 4, and the Fractional Digits = 2, the mark for the Maximum will be 50.00.

4.4.5. Advanced Settings

This section describes how to define the advanced settings for the following types of objects:



Bit Button, Toggle Switch, Screen Button, Function Button, Slide Switch, Word Button, Multi-state Switch, Radio Button Group, Step Button, Advanced Numeric Display, ASCII String Entry, and Recipe Selector.

You can use the Advanced page in an object's property sheet to define the advanced settings of that object.

The following are examples of the Advanced page for different objects:

For an advanced numeric display.	For a bit button.
<p>General Range Advanced Visibility Output Macro</p> <p>Touch Operation Control</p> <p><input type="checkbox"/> Enabled by Bit <input checked="" type="checkbox"/> Show Disabled Sign</p> <p><input checked="" type="checkbox"/> Enabled by User Level Lowest Enabling User Level: 5</p> <p><input checked="" type="checkbox"/> Timeout Timeout Time: 20 seconds</p> <p><input checked="" type="checkbox"/> Notification Signal: <input checked="" type="radio"/> Level <input type="radio"/> Pulse Bit: \$U9.0 State: <input type="radio"/> ON <input checked="" type="radio"/> OFF</p> <p><input checked="" type="checkbox"/> Operator Confirmation Maximum Waiting Time: 5 seconds</p> <p><input type="checkbox"/> Operation Logging</p>	<p>General Label Advanced Visibility</p> <p>Touch Operation Control</p> <p><input checked="" type="checkbox"/> Enabled by Bit <input checked="" type="checkbox"/> Show Disabled Sign Control Bit: W90.A Enabling State: <input checked="" type="radio"/> ON <input type="radio"/> OFF <input type="checkbox"/> Enabled by User Level</p> <p>Minimum Hold Time: 3 second(s)</p> <p><input checked="" type="checkbox"/> Operator Confirmation Maximum Waiting Time: 10 second(s)</p> <p><input type="checkbox"/> Notification</p> <p><input checked="" type="checkbox"/> Operation Logging Message: Start pump #3</p>

The following table describes each property in the Advanced page.

Property	Description	
Touch Operation Control	Enabled by Bit	Check this option so the touch operation of the numeric entry will be enabled and disabled by the specified bit.
	Control Bit	Specifies the bit that enables and disables the touch operation. Click  to enter a bit address. Click  to select a bit tag.
	Enabling State	Specifies the state (On or Off) that enables the touch operation.
	Enabled by User Level	Check this item so the touch operation of the numeric entry will be enabled and disabled by the current user level.
	Lowest Enabling User Level	Specifies the lowest user level that is required to enable the touch operation.
	Show Disabled Sign	Check this option so the touch operation disabled sign will be shown on the numeric entry when the touch operation is disabled.



Continued

Property		Description						
Timeout	Timeout	Check this option so the data entry will be cancelled if the numeric keypad does not receive any input within the specified time.						
	Timeout Time	Specifies the maximum time that the numeric keypad will wait to receive a new input. If there is no input within the specified time, the numeric keypad will be closed and the data entry will be cancelled.						
Notification	Notification	Check this option so the numeric entry will notify the specified bit after it finishes outputting the entered value to the destination variable.						
	Signal	Select one of the following signals for the notification: <table border="1" data-bbox="497 519 1506 649"> <thead> <tr> <th>Signal</th> <th>Description</th> </tr> </thead> <tbody> <tr> <td>Level</td> <td>Set the specified bit to the specified state.</td> </tr> <tr> <td>Pulse</td> <td>Send a positive pulse to the specified bit.</td> </tr> </tbody> </table>	Signal	Description	Level	Set the specified bit to the specified state.	Pulse	Send a positive pulse to the specified bit.
	Signal	Description						
	Level	Set the specified bit to the specified state.						
	Pulse	Send a positive pulse to the specified bit.						
Bit	Specifies the bit that receives the notification.							
State	Specifies the state (On or Off) that is used for the notification.							
Operator Confirmation	Operator Confirmation	Check this option if you want the operator to confirm what he/she enters for the numeric entry. The Confirmation box will be displayed when a value is entered for numeric entry. If the operator selects "Yes" in the Confirmation box, the numeric entry will write the entered value to the specified variable. If the operator selects "No" or if the operator does not respond within the specified time period (Maximum Waiting Time), the numeric entry will cancel the data entry operation.						
	Maximum Waiting Time	Specifies the maximum time that the numeric entry will wait for the operator's confirmation. The data entry will be cancelled if the operator does not respond within this time.						
Operation Logging	Operation Logging	Check this option so the following three items will be recorded in the operation log when the numeric entry outputs the entered value. There are three recorded items: 1) The time when the operation is performed 2) The entered value 3) The predefined operation message						
	Message	Enter the operation message of the first language here.						
		Click this button to bring up the Operation Message dialog box that you can edit the operation message for all the languages.						
Minimum Hold Time		Available when the object is a button or switch. The touch operation of the button will not be activated until the button is pressed and held down for the specified time period (Minimum Hold Time).						



4.4.6. Visibility Settings

In the Visibility page of an object's property sheet, you can define how to show and hide the object. You can also modify the position and size of an object with the Visibility page.

The following are examples of the Visibility page:

The option "Controlled by Bit" is checked	The option "Controlled by User Level" is checked
<div style="text-align: center; border: 1px solid gray; padding: 5px; margin-bottom: 10px;">Visibility</div> <div style="border: 1px solid gray; padding: 10px;"> <input type="checkbox"/> Invisible <input checked="" type="checkbox"/> Controlled by Bit Control Bit: <input type="text" value="M10.0"/>   Visible State: <input checked="" type="radio"/> ON <input type="radio"/> OFF <input type="checkbox"/> Controlled by User Level <div style="border: 1px solid gray; padding: 5px; margin-top: 10px;"> Dimension Left: <input type="text" value="160"/> <input type="text" value="31"/> Width: <input type="text" value="31"/> Top: <input type="text" value="158"/> <input type="text" value="34"/> Height: <input type="text" value="34"/> <input type="button" value="Redraw"/> </div> </div>	<div style="text-align: center; border: 1px solid gray; padding: 5px; margin-bottom: 10px;">Visibility</div> <div style="border: 1px solid gray; padding: 10px;"> <input type="checkbox"/> Invisible <input type="checkbox"/> Controlled by Bit <input checked="" type="checkbox"/> Controlled by User Level Lowest Visible User Level: <input type="text" value="5"/> <input type="button" value="v"/> <div style="border: 1px solid gray; padding: 5px; margin-top: 10px;"> Dimension Left: <input type="text" value="160"/> <input type="text" value="31"/> Width: <input type="text" value="31"/> Top: <input type="text" value="158"/> <input type="text" value="34"/> Height: <input type="text" value="34"/> <input type="button" value="Redraw"/> </div> </div>

The following table describes each property in the Visibility page.

Property		Description
Invisible		Check this option so the object will always be invisible. Note: The touch operation is still enabled with this setting.
Controlled by Bit	Controlled by Bit	Check this option so the object will be shown and hidden by the specified bit.
	Control Bit	Specifies the bit that will show or hide the object. Click  to enter the bit address. Click  to enter the bit tag.
	Visible State	Specifies the state (On or Off) that makes the object visible.
Controlled by User Level	Controlled by User Level	Check this option so the object will be shown and hidden by the current user level.
	Lowest Visible User Level	Specifies the lowest user level that is required to show the object.
Dimension	Left	Specifies the X coordinate of the object's upper-left corner on the screen.
	Top	Specifies the Y coordinate of the object's upper-left corner on the screen.
	Width	Specifies the width (in pixels) of the object.
	Height	Specifies the height (in pixels) of the object.
	<input type="button" value="Redraw"/>	Click this button to redraw the object with the new settings.

CHAPTER 5

BUTTONS AND SWITCHES

5.1. Changing Bit State Using Bit Buttons	1
5.1.1. Basic Operations.....	1
5.1.2. Operation Options.....	2
5.1.3. Settings	3
5.1.4. General Settings.....	4
5.2. Toggling Bit State Using Toggle Switches.....	6
5.2.1. Settings	6
5.2.2. General Settings.....	7
5.3. Changing Screens Using Screen Buttons.....	9
5.3.1. Basic Operations.....	9
5.3.2. Operation Options.....	9
5.3.3. Settings	10
5.3.4. General Settings.....	11
5.4. Performing Built-in Function Using Function Buttons.....	14
5.4.1. Basic Operations.....	14
5.4.2. Operation Options.....	17
5.4.3. Settings	18
5.4.4. General Settings.....	19
5.5. Selecting Word Value Using Slide Switches	21
5.5.1. Basic Operations.....	21
5.5.2. Operation Options.....	22
5.5.3. Settings	22
5.5.4. General Settings.....	23
5.6. Setting Word Value Using Word Buttons.....	25
5.6.1. Basic Operations.....	25
5.6.2. Operation Options.....	25
5.6.3. Settings	26
5.6.4. General Settings.....	26

5.7.	Selecting Work Value Using Multi-state Switches.....	28
5.7.1.	Basic Operations.....	28
5.7.2.	Operation Options.....	29
5.7.3.	Settings	30
5.7.4.	General Settings.....	31
5.8.	Setting Word State Using Radio Button Groups.....	33
5.8.1.	Basic Operations.....	33
5.8.2.	Operation Options.....	33
5.8.3.	Settings	34
5.8.4.	General Settings.....	34
5.9.	Customizing the Keypad Using Keypad Buttons	36
5.9.1.	Operation Options.....	36
5.9.2.	Settings	36
5.9.3.	General Settings.....	37
5.9.4.	Creating your own keypads	38
5.10.	Scrolling Object Content Using Scroll Button Groups.....	40
5.10.1.	Basic Operations.....	40
5.10.2.	Operation Options.....	41
5.10.3.	Settings	41
5.10.4.	General Settings.....	42
5.11.	Scrolling Object Content Using Scroll Bars.....	43
5.11.1.	Basic Operations.....	43
5.11.2.	Operation Options.....	44
5.11.3.	Settings	44
5.11.4.	General Settings.....	45
5.12.	Stepping Through Word State Using Step Buttons	46
5.12.1.	Basic Operations.....	46
5.12.2.	Operation Options.....	46
5.12.3.	Settings	47
5.12.4.	General Settings.....	47
5.13.	Displaying Window Screen as Information Page Using Page Selectors	50
5.13.1.	Basic Operations.....	50
5.13.2.	Settings	50
5.13.3.	General Settings.....	51

5.1. Changing Bit State Using Bit Buttons

You can touch a bit button to change the state of the specified bit.

5.1.1. Basic Operations

A bit button can be configured to perform the following operations:

Operation	Description
Set ON	Sets the specified bit to On when the button is pressed.
Set OFF	Sets the specified bit to Off when the button is pressed.
Set ON Pulse	Sets the specified bit to On when the button is pressed and then sets the bit to Off to generate a positive pulse with the specified pulse width.
Set OFF Pulse	Sets the specified bit to Off when the button is pressed and then sets the bit to On to generate a negative pulse with the specified pulse width.
Momentary ON	Sets the specified bit to On when the button is pressed and sets the bit to Off when the button is released. Note: Pressing and releasing a momentary button quickly might generate a pulse that is too short to be detected by the controller. To avoid this problem, specify a sufficient minimum pulse width for the operation; so the setting of the bit to Off is delayed if necessary to generate a pulse that is always detectable.
Momentary OFF	Sets the specified bit to Off when the button is pressed and sets the bit to On when the button is released. Note: See the note above.
Invert	Inverts the state of the specified bit when the button is pressed.

Note: You can configure a bit button to operate a bit of a word or a bit of a double-word. In these instances, you need to specify the number of the bit to be operated.

5.1.2. Operation Options

The following operation options can be selected for a bit button to make it more informative, secure, and useful. You need to select and set those options in the Bit Button property sheet.

Option	Description																								
Monitor	The bit button can be configured to monitor a bit. When this option is selected, the state of the button is controlled by the monitored bit. With the monitored bit, you can control the color and label of the bit button.																								
ON Macro, OFF Macro	<p>An ON Macro is a macro that is run when the associated button is activated to set a bit to 1 (On). An OFF Macro, on the contrary, is a macro that is run when the associated button is activated to set a bit to 0 (Off). The following table shows the macros that each bit button operation can support.</p> <table border="1"> <thead> <tr> <th>Operation</th> <th>ON Macro</th> <th>OFF Macro</th> </tr> </thead> <tbody> <tr> <td>Set ON</td> <td>•</td> <td></td> </tr> <tr> <td>Set OFF</td> <td></td> <td>•</td> </tr> <tr> <td>Set ON Pulse</td> <td>•</td> <td></td> </tr> <tr> <td>Set OFF Pulse</td> <td></td> <td>•</td> </tr> <tr> <td>Momentary ON</td> <td>•</td> <td>•</td> </tr> <tr> <td>Momentary OFF</td> <td>•</td> <td>•</td> </tr> <tr> <td>Invert</td> <td></td> <td></td> </tr> </tbody> </table> <p>Select these options in the General Page. Specify and edit the ON macro in the ON Macro page. Specify and edit the OFF macro in the OFF Macro page.</p> <p>Note: When an ON macro or OFF macro is specified, the associated bit setting operation is not performed until the macro is completely executed. Therefore, it is important to keep ON and OFF macros as short as possible so as not to delay the bit setting operation.</p>	Operation	ON Macro	OFF Macro	Set ON	•		Set OFF		•	Set ON Pulse	•		Set OFF Pulse		•	Momentary ON	•	•	Momentary OFF	•	•	Invert		
Operation	ON Macro	OFF Macro																							
Set ON	•																								
Set OFF		•																							
Set ON Pulse	•																								
Set OFF Pulse		•																							
Momentary ON	•	•																							
Momentary OFF	•	•																							
Invert																									
Touch Operation Control	The touch operation can be enabled or disabled either by a specified bit or by the current user level. Select and set this option in the Advanced page.																								
Minimum Hold Time	The touch operation of the button will not be activated until the button is pressed and held down for the specified time period (Minimum Hold Time). Set this option in the Advanced page.																								
Operator Confirmation	<p>This option is available for the following bit button operations: Set ON, Set OFF, Set ON Pulse, Set OFF Pulse, and Invert.</p> <p>The Confirmation box will display when the button is touched. If the operator selects “Yes” in the Confirmation box, the button will proceed to perform its operation. If the operator selects “No” or the operator does not respond within the specified time period (Maximum Waiting Time), the button will stop performing its operation.</p> <p>Select and set this option in the Advanced page.</p>																								
Notification	The button can be configured to notify a bit upon completion of the bit setting operation when the button is pressed. Select and set this option in the Advanced page.																								
Operation Logging	Each touch operation of the button can be recorded in the operation log. Select and set this option in the Advanced page.																								
Invisible	The button can be invisible and still touch operable. Select this option in the Visibility page.																								
Visibility Control	The button can be shown or hidden either by a specified bit or by the current user level. Select and set this option in the Visibility page.																								

5.1.3. Settings

You can complete all the settings of a bit button in the Bit Button property sheet. This sheet contains the following seven pages. Some of the pages appear only when they are needed.

- **General**

Described in [Section 5.1.4.](#)

- **Label**

Described in [Section 4.3.5.](#)

- **Advanced**

Described in [Section 4.4.5.](#)

- **Visibility**

Described in [Section 4.4.6.](#)

- **External Label**

Described in [Section 4.3.8.](#)

- **On Macro**

Described in [Section 14.2.6.](#)

- **OFF Macro**



Described in [Section 14.2.6.](#)

5.1.4. General Settings

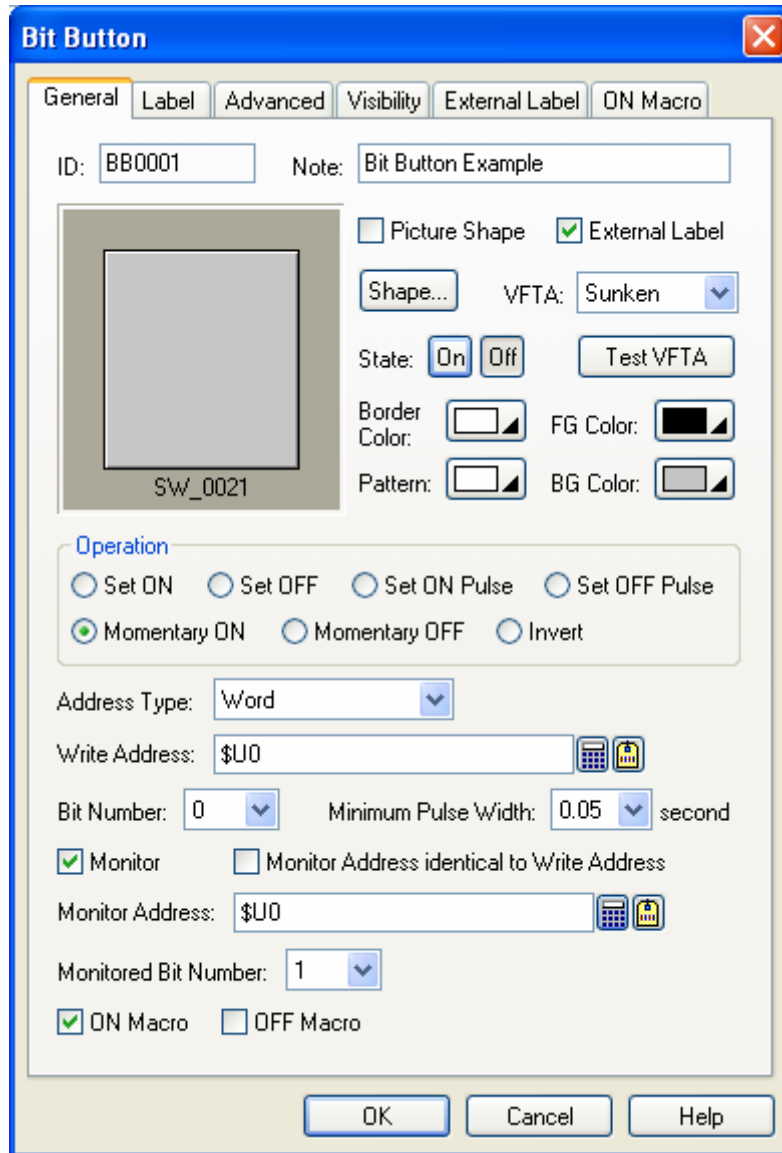

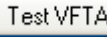

This section describes how to define the general settings for the bit buttons in the General page of the Bit Button property sheet. The following is an example of the General page.



The following table describes each property in the General page.

Property	Description
ID	The object's identifier. It is generated when the object is created. The identifier is unique within the screen where the object is located. The format of the IDs for the bit buttons is BBnnnn.
Note	You can type a note for the bit button.
Shape settings	For details about the following properties, see Section 4.3.4 Setting up the Shape of an Object . Picture Shape,  , VFTA,  , Border Color, Pattern, FG Color, BG Color
External Label	Check this option if you want the bit button to have an external label. Set up the external label in the External Label page.
	Click this button to change the object state to 1 (On) so you can view and set the object appearance for state 1 (On).
	Click this button to change the object state to 0 (Off) so you can view and set the object appearance for state 0 (Off).

Continued

Property		Description								
Operation		Select the operation for the bit button. There are 7 choices: Set ON, Set OFF, Set ON Pulse, Set OFF Pulse, Momentary ON, Momentary OFF, and Invert. For details, see Section 5.1.1 Basic Operations								
Address Type		Specifies the type of variable in the Write Address field. The bit buttons support the following three variable types: <table border="1" data-bbox="400 398 1489 689"> <thead> <tr> <th>Variable Type</th> <th>Description</th> </tr> </thead> <tbody> <tr> <td>Bit</td> <td>The variable is a bit variable.</td> </tr> <tr> <td>Word</td> <td>The variable is a word variable. You need to specify which bit of the word variable is to be operated. Specify the bit number (0~15) in the Bit Number field.</td> </tr> <tr> <td>Double-word</td> <td>The variable is a double-word variable. You need to specify which bit of the double-word variable is to be operated. Specify the bit number (0~31) in the Bit Number field.</td> </tr> </tbody> </table>	Variable Type	Description	Bit	The variable is a bit variable.	Word	The variable is a word variable. You need to specify which bit of the word variable is to be operated. Specify the bit number (0~15) in the Bit Number field.	Double-word	The variable is a double-word variable. You need to specify which bit of the double-word variable is to be operated. Specify the bit number (0~31) in the Bit Number field.
Variable Type	Description									
Bit	The variable is a bit variable.									
Word	The variable is a word variable. You need to specify which bit of the word variable is to be operated. Specify the bit number (0~15) in the Bit Number field.									
Double-word	The variable is a double-word variable. You need to specify which bit of the double-word variable is to be operated. Specify the bit number (0~31) in the Bit Number field.									
Write Address	Write Address	Specifies the bit variable to be operated when the Address Type is Bit. Specifies the word variable that contains the bit to be operated when the Address Type is Word. Specifies the double-word variable that contains the bit to be operated when the Address Type is Double-word.								
		Click this icon to bring up the Address Input Keypad and specify the desired address for the Write Address field.								
		Click this icon to bring up the Select Tag dialog box and select the desired tag for the Write Address field.								
	Bit Number	Specifies which bit of the variable specified in the Write Address field is to be operated. The field is available only when the address type is Word and Double Word.								
Minimum Pulse Width		The minimum width of the pulse that the Momentary ON and Momentary OFF operations must generate. There are six choices available: 0.05, 0.1, 0.2, 0.3, 0.4, and 0.5 second.								
Pulse Width		The width of the pulse generated by the Set ON Pulse and Set OFF Pulse operations. There are six choices available: 0.05, 0.1, 0.2, 0.3, 0.4, and 0.5 second.								
Monitor		Check this option if you want the bit button to monitor a specified bit and display its state.								
Monitor Address identical to Write Address		Specifies that the Monitor Address is identical to the Write Address. With this item checked, you don't need to specify the Monitor Address again. This item is available when the Monitor option is checked.								
Monitor Address	Monitor Address	Specifies the bit variable to be monitored when the Address Type is Bit. Specifies the word variable that contains the bit to be monitored when the Address Type is Word. Specifies the double-word variable that contains the bit to be monitored when the Address Type is Double-word.								
		Click this icon to bring up the Address Input Keypad and specify the desired address for the Monitor Address field.								
		Click this icon to bring up the Select Tag dialog box and select the desired tag for the Monitor Address field.								
	Monitored Bit Number	Specifies which bit of the variable specified in the Monitor Address field is to be operated. The field is available only when the address type is Word and Double Word.								
ON Macro		Check this option if you want the button to have an ON macro. Specify and edit the ON macro in the ON Macro page. This option is available when the bit button operation is Set ON, Set ON Pulse, Momentary ON, or Momentary OFF.								
OFF Macro		Check this option if you want the button to have an OFF macro. Specify and edit the OFF macro in the OFF Macro page. This option is available when the bit button operation is Set OFF, Set OFF Pulse, Momentary ON, or Momentary OFF.								
Key		The hard key that is used to operate the bit button. This item is available only when the target panel has hard keys.								

5.2. Toggling Bit State Using Toggle Switches

You can touch a toggle switch to toggle the state of the specified bit.

The difference between a toggle switch and a bit button performing the Invert operation is described below:

- 1) A toggle switch performs the toggle operation by writing the inverse state of the monitored bit to the destination bit.
- 2) A bit button performs the Invert operation by inverting the destination bit directly, regardless of the monitored bit.

5.2.1. Settings

You can complete all the settings of a toggle switch in the Toggle Switch property sheet. This sheet contains the following seven pages. Some of the pages appear only when they are needed.

- **General**

Described in [Section 5.2.2.](#)

- **Label**

Described in [Section 4.3.5.](#)

- **Advanced**

Described in [Section 4.4.5.](#)

- **Visibility**

Described in [Section 4.4.6.](#)

- **External Label**

Described in [Section 4.3.8.](#)

- **On Macro**

Described in [Section 14.2.6.](#)

- **OFF Macro**

Described in [Section 14.2.6.](#)

5.2.2. General Settings

This section describes how to define the general settings for a toggle switch.

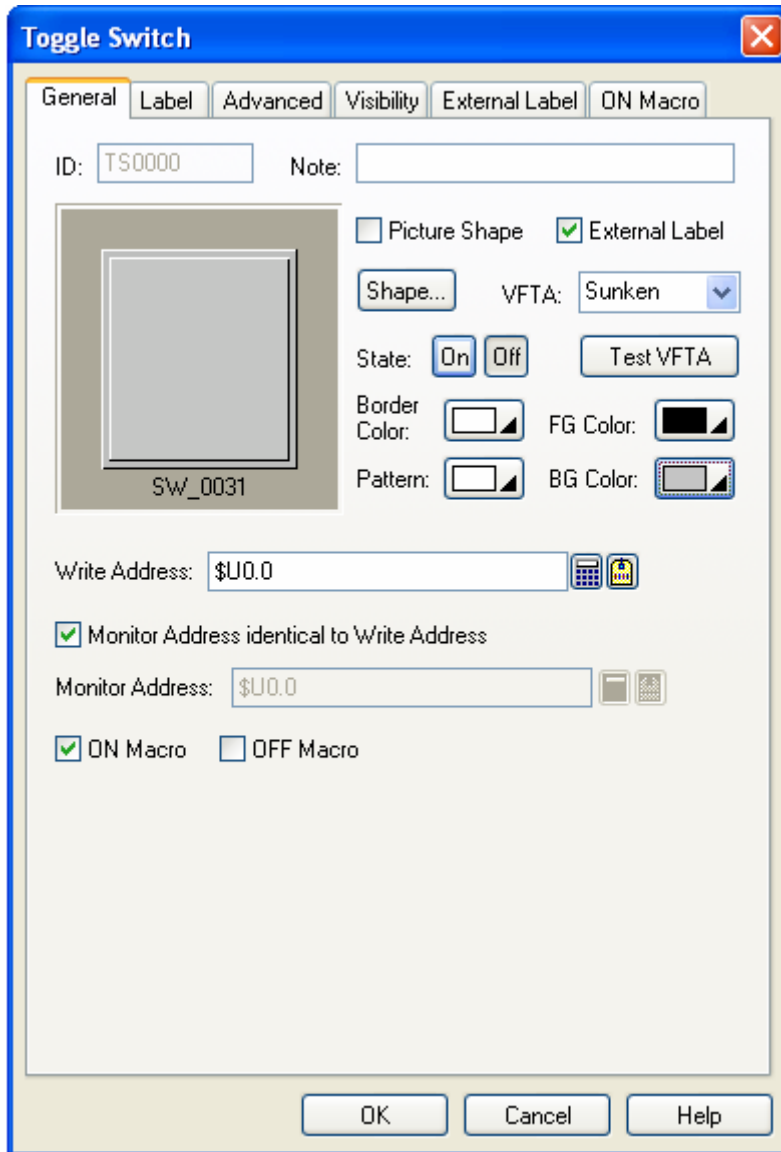







The above is an example of the General page of the Toggle Switch property sheet.

The following table describes each property in the General page.

Property	Description
ID	The object's identifier. It is generated when the object is created. The identifier is unique within the screen where the object is located. The format of the IDs for toggle switches is TSnnnn.
Note	You can type a note for the object.
Shape settings	For details about the following properties, see Section 4.3.4 Setting up the Shape of an Object. Picture Shape, <input type="button" value="Shape..."/> , VFTA, <input type="button" value="Test VFTA"/> , Border Color, Pattern, FG Color, BG Color
External Label	Check this option if you want the object to have an external label. Set up the external label in the External Label page.

Continued

Property		Description
		Click this button to change the object state to 1 (On) so you can view and set the object appearance for state 1 (On).
		Click this button to change the object state to 0 (Off) so you can view and set the object appearance for state 0 (Off).
Write Address	Write Address	Specifies the bit variable to be operated.
		Click this icon to bring up the Address Input Keypad and specify a bit address for the Write Address field.
		Click this icon to bring up the Select Tag dialog box and select a bit tag for the Write Address field.
Monitor Address identical to Write Address		Specifies that the Monitor Address is identical to the Write Address. With this item checked, you don't need to specify the Monitor Address again. This item is available when the Monitor option is checked.
Monitor Address	Monitor Address	Specifies the bit variable to be monitored.
		Click this icon to bring up the Address Input Keypad and specify a bit address for the Monitor Address field.
		Click this icon to bring up the Select Tag dialog box and select a bit tag for the Monitor Address field.
ON Macro		Check this option if you want the button to have an ON macro. Specify and edit the ON macro in the ON Macro page.
OFF Macro		Check this option if you want the button to have an OFF macro. Specify and edit the OFF macro in the OFF Macro page.
Key		The hard key that is used to operate the object. This item is available only when the target panel has hard keys.

5.3. Changing Screens Using Screen Buttons

You can touch a screen button to open or close a screen.

5.3.1. Basic Operations

A screen button can be configured to perform one of the following screen switching operations:

Operation	Description
Open Screen	Opens the specified screen.
Previous Screen	Closes the current main screen and opens the previous main screen. Note: The panel can display many window screens but only one normal screen at a time, so a normal screen is also called a main screen. The panel can remember up to 32 previously opened main screens.
Close & Open Screen	Closes the window screen where the screen button is located and opens the specified screen.
Close Screen	Closes the window screen where the screen button is located.

5.3.2. Operation Options

The following operation options can be selected for a screen button to make it more informative, secure, and useful. You need to select and set these options in the Screen Button property sheet.

Options	Description
Change User Level	The button can be configured to change the current user level.
Acknowledge Alarm	The button can be configured to acknowledge the associated alarm on the screen where it is located. You can configure an alarm to display an (alarm) screen. The alarm is then the screen's associated alarm.
Indicate Screen Already Opened	The button can be configured to indicate that a specified screen is opened. The indication is done by exchanging the button's FG color with its text color.
Macro	You can specify a macro that will run when the screen button is activated to perform its operation. Select this option in the General page. Specify and edit the macro in the Macro page. Note: The screen switching operation will not be performed until the macro is completely executed. Therefore, it is important to keep the macro as short as possible so as not to delay the operation.
Touch Operation Control	The touch operation can be enabled or disabled either by a specified bit or by the current user level. Select and set this option in the Advanced page.
Minimum Hold Time	The touch operation of the button will not be activated until the button is pressed and held down for the specified time period (Minimum Hold Time). Select and set this option in the Advanced page.
Notification	The screen button can be configured to notify a bit of the completion of the screen switching operation. Select and set this option in the Advanced page.
Operation Logging	Each touch operation of the button can be recorded in the operation log. Select and set this option in the Advanced page.
Invisible	The button can be invisible and still touch operable. Select this option in the Visibility page.
Visibility Control	The button can be shown or hidden either by a specified bit or by the current user level. Select and set this option in the Visibility page.

5.3.3. Settings

You can complete all the settings of a screen button in the Screen Button property sheet. This sheet contains the following six pages. Some of the pages appear only when they are needed.

- **General**

Described in [Section 5.3.4.](#)

- **Label**

Described in [Section 4.3.5.](#)

- **Advanced**

Described in [Section 4.4.5.](#)

- **Visibility**

Described in [Section 4.4.6.](#)

- **External Label**

Described in [Section 4.3.8.](#)

- **Macro**

Described in [Section 14.2.6.](#)

5.3.4. General Settings

This section describes how to define the general settings for a screen button.

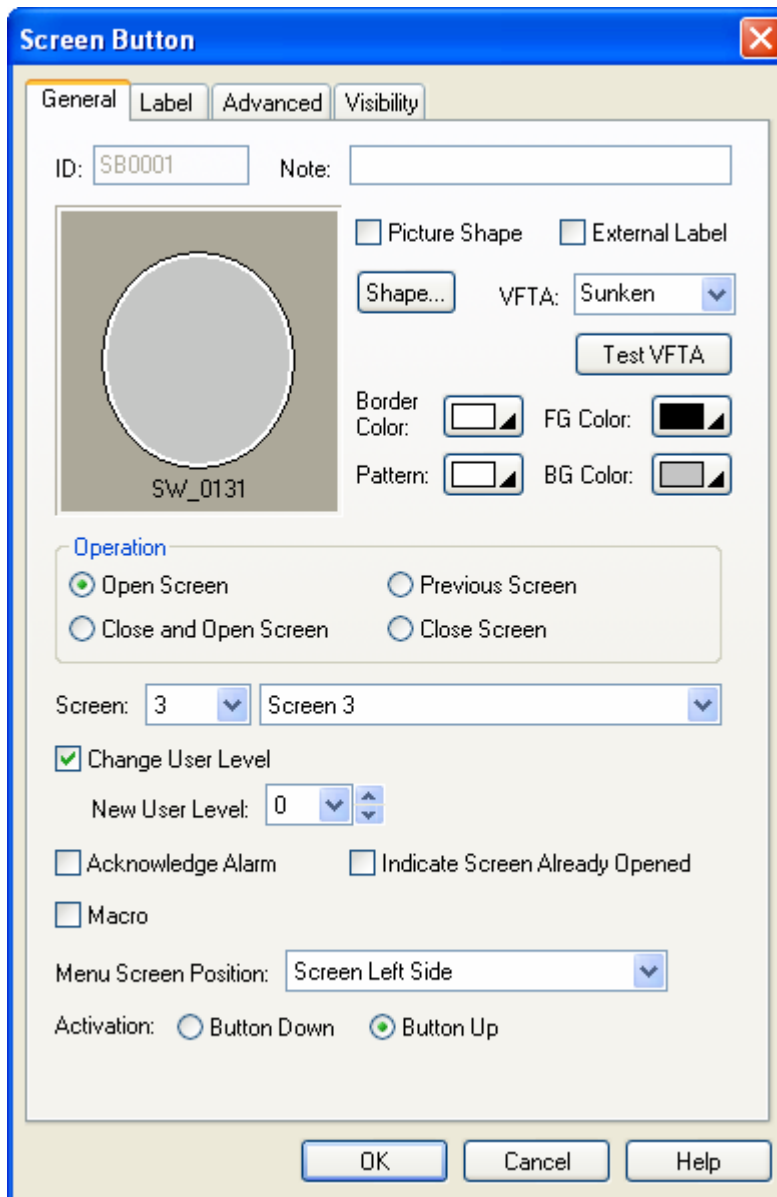

The above is an example of the General page of the Screen Button dialog box.

The following table describes each property in the General page.

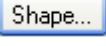
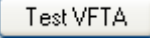
Property		Description
ID		The object's identifier. It is generated when the object is created. The identifier is unique within the screen where the object is located. The format of the IDs for screen buttons is SBnnnn.
Note		You can type a note for the object.
Shape settings		For details about the following properties, see Section 4.3.4 Setting up the Shape of an Object . Picture Shape,  , VFTA,  , Border Color, Pattern, FG Color, BG Color
External Label		Check this option if you want the object to have an external label. Set up the external label in the External Label page.
Operation		Specifies the operation that you want the screen button to perform. There are four choices: Open Screen, Previous Screen, Close and Open Screen, and Close Screen. For details, see Section 5.3.1 Basic Operations .
Screen		Specifies the screen to be opened.
Change User Level	<Check Box>	Check this option if you want the button to change the current user level.
	New User Level	The new user level to replace the current user level.
Acknowledge Alarm		Check this option if you want the button to acknowledge the associated alarm of the screen where the button is located. You can configure an alarm to display an (alarm) screen. The alarm is then the screen's associated alarm.
Indicate Screen Already Opened		Check this option if you want the button to indicate the specified screen is already open.
Macro		Check this option if you want the button to have a macro. Specify and edit the macro in the Macro page.
Activation	Button Down	Specifies that the touch operation is activated when the button is pushed.
	Button Up	Specifies that the touch operation is activated when the button is released.
Key	The hard key that is used to operate the object. This item is available only when the target panel has hard keys.	

Continued

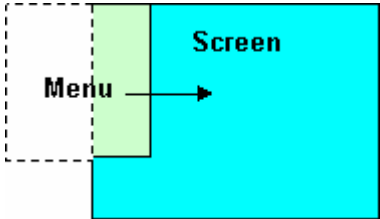
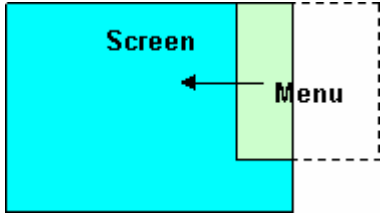
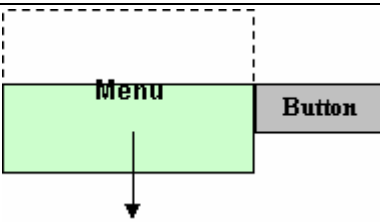
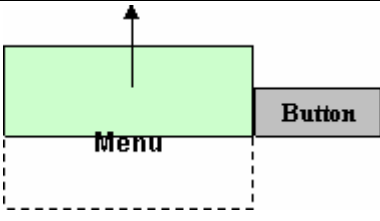
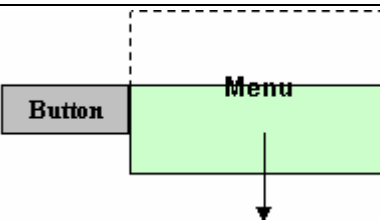
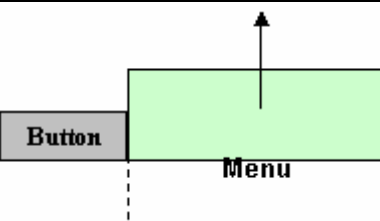
Property	Description	
Menu Screen Position	Select one of the following 6 positions for the specified menu screen to be displayed. This field will be displayed only when the specified screen is a menu screen.	
	Position	Description
	Screen Left Side	<p>The menu screen slides into view horizontally from the left side of the screen.</p> 
	Screen Right Side	<p>The menu screen slides into view horizontally from the right side of the screen.</p> 
	Button Left Side & Downward	<p>The menu screen appears on the left side of the button and slides downward into view.</p> 
	Button Left Side & Upward	<p>The menu screen appears on the left side of the button and slides upward into view.</p> 
	Button Right Side & Downward	<p>The menu screen appears on the right side of the button and slides downward into view.</p> 
	Button Right Side & Upward	<p>The menu screen appears on the right side of the button and slides upward into view.</p> 

5.4. Performing Built-in Function Using Function Buttons

You can touch a function button to perform the specified built-in function provided by the target panel.

5.4.1. Basic Operations

Category	Operation	Description												
Setting up Panel	Increase Brightness/Contrast	Increases either the brightness or the contrast of the display depending on the target panel. Not all target panels support this operation. Check the hardware manual for details.												
	Decrease Brightness/Contrast	Decreases either the brightness or the contrast of the display depending on the target panel. Not all target panels support this operation. Check the hardware manual for details.												
	Save Brightness/Contrast	Saves the setting of either the brightness or the contrast of the display depending on the target panel. Not all target panels support this operation. Check the hardware manual for details.												
	Enter Panel Setup Mode	Exits the application and enters the panel setup mode.												
	End Transparent Communication	Ends the transparent communication.												
	Show Real Time Clock	Displays the settings of the Real Time Clock so you can change the settings.												
	Turn Backlight Off	Turns off the backlight of the display. To turn on the backlight, touch the screen. Not all target panels support this operation. Check the hardware manual for details.												
Setting up Application	Log In	Displays the password keypad so you can enter a password to change the current user level.												
	Log Out	Changes the current user level to 0.												
	Show Password Table	Displays the password table so you can change the passwords. The password table only lists the passwords whose user level is equal to or less than the current user level.												
	Acknowledge Alarm	Acknowledges the associated alarm of the screen that the button is located.												
	Change Language	Change the current language to the specified language.												
	Show File Selection Box	Displays the File Selection box for the specified purpose. The following table lists the five purposes: <table border="1" data-bbox="571 1413 1469 1760"> <thead> <tr> <th>Purpose</th> <th>Description</th> </tr> </thead> <tbody> <tr> <td>Open to Read</td> <td>Open the specified file for reading. The file must exist.*</td> </tr> <tr> <td>Open/create to Write</td> <td>Open the specified file for reading. A new file is created when the specified file does not exist. If the specified file exists, it will be over written.*</td> </tr> <tr> <td>Open/create to Append</td> <td>Open the specified file for appending data. A new file is created when the specified file does not exist.*</td> </tr> <tr> <td>Delete</td> <td>Delete the specified file.</td> </tr> <tr> <td>Rename</td> <td>Rename the specified file.</td> </tr> </tbody> </table>	Purpose	Description	Open to Read	Open the specified file for reading. The file must exist.*	Open/create to Write	Open the specified file for reading. A new file is created when the specified file does not exist. If the specified file exists, it will be over written.*	Open/create to Append	Open the specified file for appending data. A new file is created when the specified file does not exist.*	Delete	Delete the specified file.	Rename	Rename the specified file.
	Purpose	Description												
Open to Read	Open the specified file for reading. The file must exist.*													
Open/create to Write	Open the specified file for reading. A new file is created when the specified file does not exist. If the specified file exists, it will be over written.*													
Open/create to Append	Open the specified file for appending data. A new file is created when the specified file does not exist.*													
Delete	Delete the specified file.													
Rename	Rename the specified file.													
	<p>You can specify the File Extension Name that will limit the File Selection Box to list only the files of the specified type. The specified extension name can only have ASCII characters and at most 3 characters.</p> <p>Note: You need to specify the File I/O Control Block Address, an internal variable that receives the result of the file open operation. You can specify a macro that will run when the specified file is opened successfully. It is important to close an opened file with the macro command CLOSE_FILE when you finish the operation, or the file data will be lost.</p>													

Continued

Category	Operation	Description
Saving Data to File	Save Recipe Data (.txt file)	Saves the data of the specified recipe block in a text file. The file can be read by any text editor, Microsoft Excel, and the target panel.
	Save Recipe Data (.prd file)	Saves the data of the specified recipe block in a file using the PRD format. The file can be read by the RecipeEditor and the target panel.
	Save Logged Data (.txt file)	Saves the data collected by the specified data logger in a text file. The file can be read by any text editor, Microsoft Excel, and the target panel.
	Save Logged Data (.ldf file)	Saves the data collected by the specified data logger in an LDF file. The file can be read by the target panel only.
	Save Alarm History (.txt file)	Saves the alarm history in a text file. The file can be read by any text editor, Microsoft Excel, and the target panel.
	Save Alarm Counts (.txt file)	Saves the alarm counts in a text file. The file can be read by any text editor, Microsoft Excel, and the target panel.
	Save Operation History (.txt file)	Saves the operation history in a text file. The file can be read by any text editor, Microsoft Excel, and the target panel.
	Save Line Chart Data (.txt file)	Saves the data collected by the specified line chart in a text file. The file can be read by any text editor, Microsoft Excel, and the target panel.
	Save Scatter Chart Data (.txt file)	Saves the data collected by the specified scatter chart in a text file. The file can be read by any text editor, Microsoft Excel, and the target panel.
	Save Application Configuration Data (.plf file)	Saves the application configuration data that was downloaded to the target panel previously in a PLF file. The file can be used by the software.
	Save System and Application to File (.prp file)	Saves the system programs and the application runtime data in a PRP file. The file can be used by the software and compatible target panels.
Loading Data from File	Load Recipe Data (.txt file)	Loads the data of the specified recipe block from a text file.
	Load Recipe Data (.prd file)	Loads the data of the specified recipe block from a PRD file.
	Load Logged Data (.ldf file)	Loads the data of the specified data logger from a LDF file.
	Load Line Chart Data (.txt file)	Loads the data of the specified line chart from a text file.
	Load Scatter Chart Data (.txt file)	Loads the data of the specified scatter chart from a text file.
Transferring Data	Write Recipe to Controller	Writes the current recipe, which is determined by the current recipe block and the current recipe number, to the specified controller. The controller and the destination address are specified in the settings of the recipe block.
	Read Recipe from Controller	Updates the current recipe, which is determined by the current recipe block and the current recipe number, by reading a recipe from the specified controller. The controller and the source address are specified in the settings of the recipe block.
	Save Recipe Data to Flash ROM	Saves the data of the specified recipe block to the target panel's flash ROM. The option "Need space in flash ROM to save backup" must be selected in the settings of the recipe block to make this operation available.
	Load Recipe Data from Flash ROM	Loads the data of the specified recipe block from the target panel's flash ROM. The option "Need space in flash ROM to save backup" must be selected in the settings of the recipe block to make this operation available.

Continued

Category	Operation	Description
Printing Screen	Print Screen	Prints the screen where the button is located. The printed area is specified in the settings of the screen properties.
	Print Screen to File (256-color .bmp)	Prints the screen where the button is located to a file with the BMP format of 256 colors. The printed area is specified in the settings of the screen properties.
	Print Screen to File (64K-color .bmp)	Prints the screen where the button is located to a file with the BMP format of 64K colors. The printed area is specified in the settings of the screen properties.
	Print Screen to File (True-color .bmp)	Prints the screen where the button is located to a file with the BMP format. The color resolution is the same as the target panel's display. The printed area is specified in the settings of the screen properties.
	Print Screen to File (.jpg)	Prints the screen where the button is located to a file with the JPG format. The printed area is specified in the settings of the screen properties.
Clearing Data	Clear Logged Data	Clears the data of the specified data logger.
	Clear Logged Data (All)	Clears the data of all the data loggers.
	Clear Alarm History	Clears the alarm history.
	Clear Alarm Counts	Resets the alarm counts to 0.
	Clear Operation History	Clears the operation history.
Running Application	Restart Application	Restarts the application.
	Update System and Application From File (.prp)	Updates the system programs and the application runtime data from a PRP file. The original system programs and the application runtime data are replaced by the new ones.
	Boot from File (.prp)	Loads-and-runs the system programs and the application runtime data from a PRP file. The original system programs and runtime data remain intact. The loaded system programs and the runtime data will be lost after power off.
Multimedia	Play Sound	Plays the specified sound file.
	Stop Playing Sound	Stops playing the current sound file
	Take Picture	Takes a picture with the specified USB camera.
Adjusting Viewing Range	Zoom In	Makes the viewing range of the associated object half the size so the object shows less content but with more detail.
	Zoom Out	Makes the viewing range of the associated object twice the size so the object shows more content but with less detail.
	Restore to Normal View	Restores the viewing range to the original setting.
Scrolling Content	Scroll Left	Scrolls the content displayed by the associated object to the left.
	Scroll Right	Scrolls the content displayed by the associated object to the right.
	Scroll Up	Scrolls the content displayed by the associated object to the top.
	Scroll Down	Scrolls the content displayed by the associated object to the bottom.
	Scroll Page Left	Scrolls the content displayed by the associated object to the left by a page.
	Scroll Page Right	Scrolls the content displayed by the associated object to the right by a page.
	Scroll Page Up	Scrolls the content displayed by the associated object to the top by a page.
	Scroll Page Down	Scrolls the content displayed by the associated object to the bottom by a page.
	Scroll to Left End	Scrolls the content displayed by the associated object to the left end.
	Scroll to Right End	Scrolls the content displayed by the associated object to the right end.
	Scroll to Bottom End	Scrolls the content displayed by the associated object to the bottom end.
	Scroll to Top End	Scrolls the content displayed by the associated object to the top end.

Continued

Category	Operation	Description
Changing Data	Select Next Data Entry Object	Selects the next data entry object on the screen where the button is on.
	Select Previous Data Entry Object	Selects the previous data entry object on the screen where the button is on.
	Increase Value by One	Activates the selected data entry object to set its specified variable to the value obtained by increasing the value of its monitored variable by one. The operation is available for multi-state buttons whose property "Activation" is set to "Indirect". The operation is available for numeric entries whose property "Data Entry" is set to "On-screen Keypad and/or Function Keys".
	Decrease Value by One	Activates the selected data entry object to set its specified variable to the value obtained by decreasing the value of its monitored variable by one. The operation is available for multi-state buttons whose property "Activation" is set to "Indirect". The operation is available for numeric entries whose property "Data Entry" is set to "On-screen Keypad and/or Function Keys".

5.4.2. Operation Options

The following operation options can be added to a function button to make it more informative, secure, and useful. You need to select and set these options in the Function Button property sheet.

Options	Description
Macro	You can specify a macro that will be run when a file is successfully opened. Select this option in the General page. Specify and edit the macro in the Macro page.
Touch Operation Control	The touch operation can be enabled and disabled either by a specified bit or by the current user level. Select and set this option in the Advanced page.
Minimum Hold Time	The touch operation of the button will not be activated until the button is pressed and held down for the specified time period (Minimum Hold Time). Set this option in the Advanced page.
Operator Confirmation	The Confirmation box will be displayed when the button is touched. If the operator selects "Yes" in the Confirmation box, the button will proceed to perform its operation. If the operator selects "No" or the operator does not respond within the specified time period (Maximum Waiting Time), the button will stop performing its operation. Select and set this option in the Advanced page.
Notification	The button can be configured to notify a bit when the specified operation is performed successfully. Select and set this option in the Advanced page.
Operation Logging	Each touch operation of the button can be recorded in the operation log. Select and set this option in the Advanced page.
Invisible	The button can be invisible and still touch operable. Select this option in the Visibility page.
Visibility Control	The button can be shown or hidden either by a specified bit or by the current user level. Select and set this option in the Visibility page.

5.4.3. Settings

You can complete all the settings of a function button in the Function Button property sheet. This sheet contains the following five pages. Some of the pages appear only when they are needed.

- **General**

Described in [Section 5.4.4.](#)

- **Label**

Described in [Section 4.3.5.](#)

- **Advanced**

Described in [Section 4.4.5.](#)

- **Visibility**

Described in [Section 4.4.6.](#)

- **Macro**

Described in [Section 14.2.6.](#)

5.4.4. General Settings

This section describes how to define the general settings for a function button.

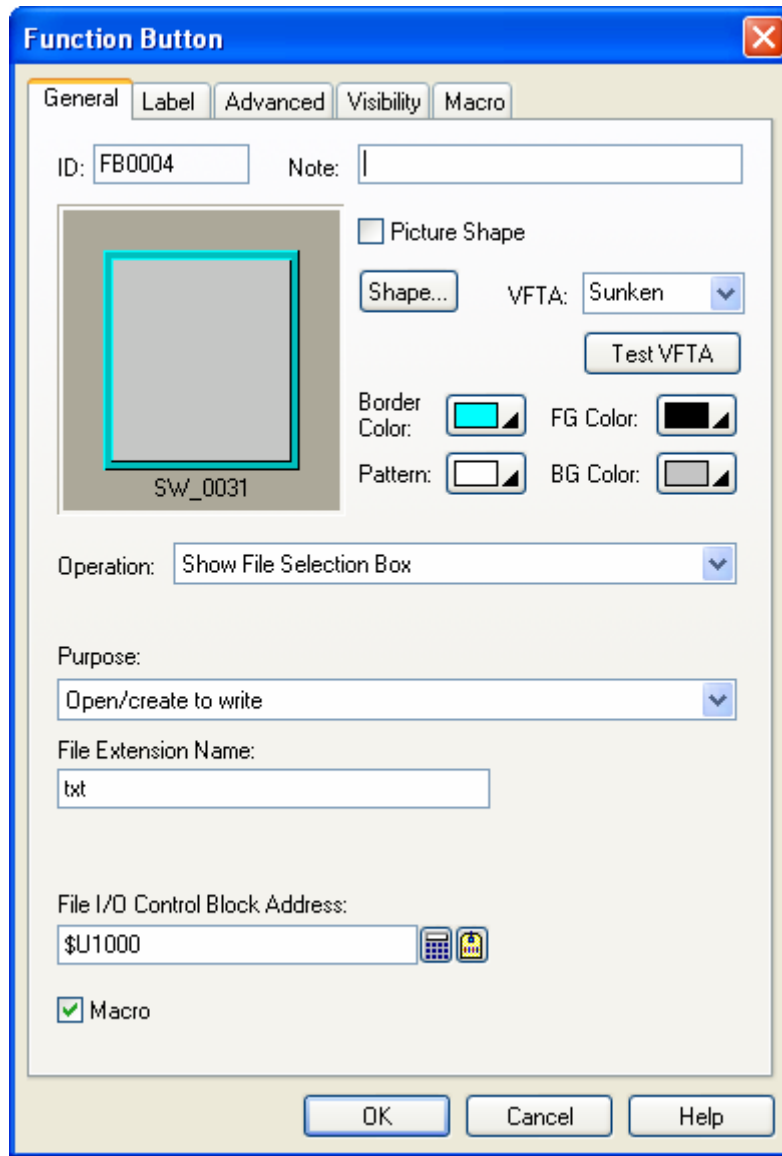

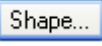
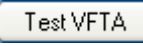

The above is an example of the General page of the Function Button dialog box.

The following table describes each property in the General page.

Property	Description
ID	The object's identifier. It is generated when the object is created. The identifier is unique within the screen where the object is located. The format of the ID's for function buttons is FBnnnn.
Note	You can type a note for the object.
Shape settings	For details about the following properties, see Section 4.3.4 Setting up the Shape of an Object . Picture Shape,  , VFTA,  , Border Color, Pattern, FG Color, BG Color

Continued

Property		Description								
External Label		Check this option if you want the object to have an external label. Set up the external label in the External Label page.								
Operation		Specifies the operation that you want the function button to perform. About the available operations, see Section 5.4.1 Basic Operation .								
ID, Purpose, or Language	Associated Object ID	The ID of the object associated with the selected operation.								
	Data Logger	The ID of the data logger associated with the selected operation.								
	Line Chart	The ID of the line chart associated with the selected operation.								
	Recipe Block	The ID of the recipe block associated with the selected operation.								
	Scatter Chart	The ID of the scatter chart associated with the selected operation.								
	Purpose	The purpose for the Show File Selection Box operation.								
	Language	The language for the Change Language operation.								
	Sound	The ID of the sound for the Play Sound operation.								
Filename, Extension name, Method	Default Filename	The default filename for the selected operation. The name can only have ASCII characters and at most 80 characters.								
	File Extension Name	The file extension name for the selected operation. The name can only have ASCII characters and at most 3 characters.								
	Method	The method for the Play Sound operation.								
Filename Selectable		Check this item so the File Selection box will display for the operator to select a file. The selected file will be used for the selected operation.								
File I/O Control Block Address	<Edit Box>	Specifies the internal variable to receive the result of the file open operation. The memory block requires 44 words.								
		<table border="1"> <thead> <tr> <th>Word</th> <th>Description</th> </tr> </thead> <tbody> <tr> <td>0,1</td> <td>A 32-bit word to store the handle of an opened file</td> </tr> <tr> <td>2,3</td> <td>A 32-bit word to store the size (in byte) of the file</td> </tr> <tr> <td>4-43</td> <td>A byte array to store the filename and the extension name of the opened file; the maximum length of the filename and the extension name is 80 characters</td> </tr> </tbody> </table>	Word	Description	0,1	A 32-bit word to store the handle of an opened file	2,3	A 32-bit word to store the size (in byte) of the file	4-43	A byte array to store the filename and the extension name of the opened file; the maximum length of the filename and the extension name is 80 characters
		Word	Description							
		0,1	A 32-bit word to store the handle of an opened file							
	2,3	A 32-bit word to store the size (in byte) of the file								
4-43	A byte array to store the filename and the extension name of the opened file; the maximum length of the filename and the extension name is 80 characters									
	Click this icon to bring up the Address Input Keypad and specify an internal address for this property.									
	Click this icon to bring up the Select Tag dialog box and select an internal tag for this property.									
Macro		Check this option if you want the button to have a macro. Specify and edit the macro in the Macro page.								
Key		The hard key that is used to operate the object. This item is available only when the target panel has hard keys.								

5.5. Selecting Word Value Using Slide Switches

You can touch the knob of a slide switch and move the knob to select a desired value. The selected value is written to the specified variable when you release the knob.

5.5.1. Basic Operations

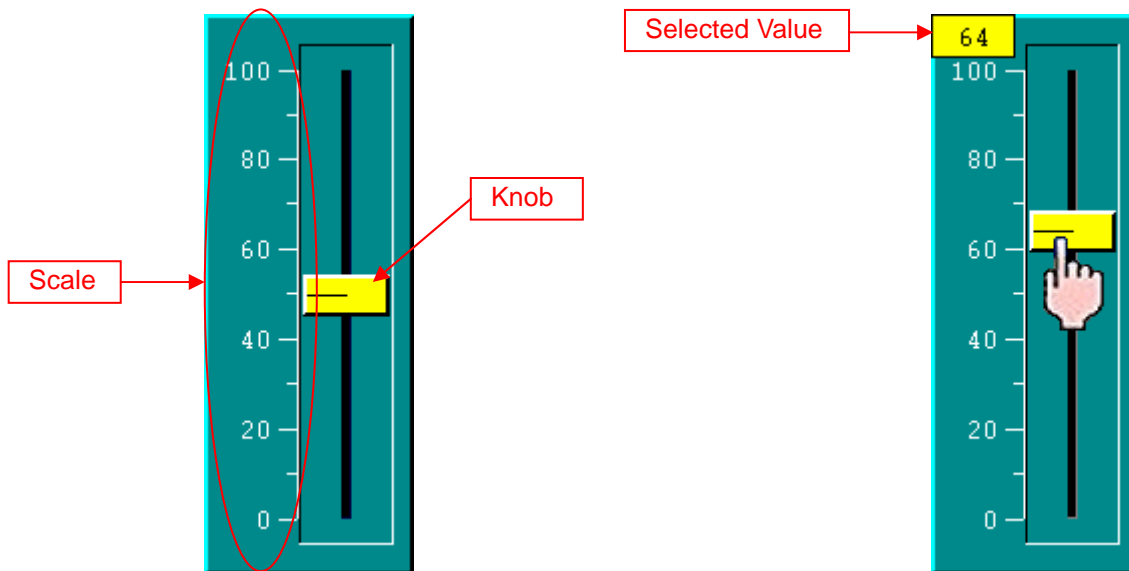

The above are two examples of slide switches. The right one shows a slide switch whose knob is being touched.

You specify the variable to be controlled, the minimum of the variable, and the maximum of the variable for a slide switch. The variable is monitored, and its value combined with the specified minimum and maximum determines the knob position of the slide switch. You can touch and move the knob to select a desired value. The selected value is shown when the knob is being held. When you release the knob, the selected value is written to the specified variable.

You can choose one of the following four directions for a slide switch:

Direction	Description
Upward	The knob can move vertically. The knob is at the top end when the variable value is equal to or greater than the specified maximum. The knob is at the bottom end when the variable value is equal to or less than the specified minimum. When the variable value is between the maximum and minimum, the knob is at a proportional position between the top end and the bottom end.
Downward	The knob can move vertically. The knob is at the bottom end when the variable value is equal to or greater than the specified maximum. The knob is at the top end when the variable value is equal to or less than the specified minimum. When the variable value is between the maximum and minimum, the knob is at a proportional position between the bottom end and the top end.
Leftward	The knob can move horizontally. The knob is at the left end when the variable value is equal to or greater than the specified maximum. The knob is at the right end when the variable value is equal to or less than the specified minimum. When the variable value is between the maximum and minimum, the knob is at a proportional position between the left end and the right end.
Rightward	The knob can move horizontally. The knob is at the right end when the variable value is equal to or greater than the specified maximum. The knob is at the left end when the variable value is equal to or less than the specified minimum. When the variable value is between the maximum and minimum, the knob is at a proportional position between the right end and the left end.

5.5.2. Operation Options

The following operation options can be added to a slide switch to make it more informative, secure, and useful. You need to select and set these options in the Slide Switch dialog box.

Options	Description
Scale	The switch can have a scale. Select and set this option in the Scale page.
Touch Operation Control	The touch operation can be enabled and disabled either by a specified bit or by the current user level. Select and set this option in the Advanced page.
Notification	The switch can be configured to notify a bit when a change to the specified variable is performed. Select and set this option in the Advanced page.
Operation Logging	Each change to the specified variable can be recorded in the operation log. Select and set this option in the Advanced page.
Visibility Control	The switch can be shown or hidden either by a specified bit or by the current user level. Select and set this option in the Visibility page.

5.5.3. Settings

You can complete all the settings of a slide switch in the Slide Switch dialog box. This dialog box contains the following five pages. Some of the pages appear only when they are needed.

- **General**

Described in [Section 5.5.4.](#)

- **Scale**

Described in [Section 4.4.4.](#)

- **Advanced**

Described in [Section 4.4.5.](#)

- **Visibility**

Described in [Section 4.4.6.](#)

- **External Label**

Described in [Section 4.3.8.](#)

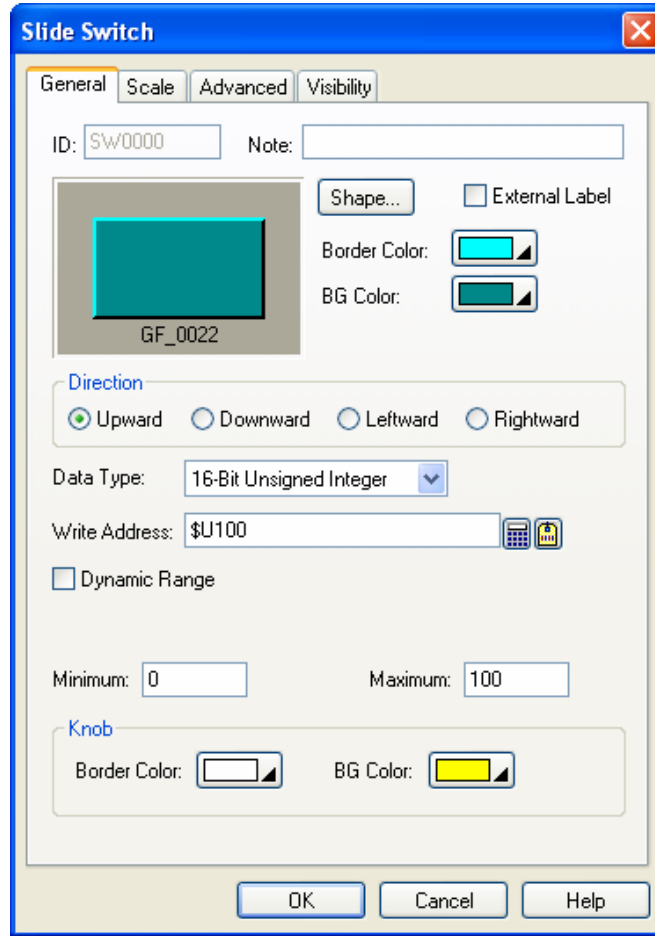

5.5.4. General Settings

This section describes how to define the general settings for a slide switch.





The above is an example of the General page of the Slide Switch dialog box.

The following table describes each property in the General page.

Property	Description	
ID	The object's identifier. It is generated when the object is created. The identifier is unique within the screen where the object is located. The format of the IDs for slide switches is SWnnnn.	
Note	You can type a note for the object.	
Shape settings	For details about the following properties, see Section 4.3.4 Setting up the Shape of an Object .  , Border Color, BG Color	
External Label	Check this option if you want the object to have an external label. Set up the external label in the External Label page.	
Direction	Specifies the direction of the slide switch. For details, see 5.5.1 Basic Operation .	
Data Type	The data type of the variable to be controlled by the object.	
Write Address	Write Address	Specifies the variable to be controlled by the object.
		Click this icon to bring up the Address Input Keypad and specify an address for this field.
		Click this icon to bring up the Select Tag dialog box and select a tag for this field.

Continued

Property		Description																															
Dynamic Range	Dynamic Range	Check this option so the minimum and maximum of the variable will be specified at runtime. When this option is selected, the minimum and maximum of the marks for the scale of the slide switch can be specified at runtime as well. The data that specifies the above two ranges should be set and arranged correctly in a memory block called the dynamic range parameter block. You need to specify the dynamic range parameter block for the slide switch in the Dynamic Range Parameter Block field.																															
	Dynamic Range Parameter Block	<p>Specifies the variable that stores the dynamic range parameter block for the slide switch when Dynamic Range is selected.</p> <p>Click  to enter an address for this field. Click  to select a tag for this field. The following table shows the data arrangement of the parameter block when the data type is 16-bit and the scale of the slide switch is not dynamic.</p> <table border="1"> <thead> <tr> <th>Word</th> <th>Parameter</th> </tr> </thead> <tbody> <tr> <td>0</td> <td>The minimum of the variable</td> </tr> <tr> <td>1</td> <td>The maximum of the variable</td> </tr> </tbody> </table> <p>The following table shows the data arrangement of the parameter block when the data type is 16-bit and the scale of the slide switch is dynamic.</p> <table border="1"> <thead> <tr> <th>Word</th> <th>Parameter</th> </tr> </thead> <tbody> <tr> <td>0</td> <td>The minimum of the variable</td> </tr> <tr> <td>1</td> <td>The maximum of the variable</td> </tr> <tr> <td>2, 3</td> <td>The minimum of the mark for the scale; 32-bit integer number</td> </tr> <tr> <td>4, 5</td> <td>The maximum of the mark for the scale; 32-bit integer number</td> </tr> </tbody> </table> <p>The following table shows the data arrangement of the parameter block when the data type is 32-bit and the scale of the slide switch is not dynamic.</p> <table border="1"> <thead> <tr> <th>Word</th> <th>Parameter</th> </tr> </thead> <tbody> <tr> <td>0, 1</td> <td>The minimum of the variable</td> </tr> <tr> <td>2, 3</td> <td>The maximum of the variable</td> </tr> </tbody> </table> <p>The following table shows the data arrangement of the parameter block when the data type is 32-bit and the scale of the slide switch is dynamic.</p> <table border="1"> <thead> <tr> <th>Word</th> <th>Parameter</th> </tr> </thead> <tbody> <tr> <td>0, 1</td> <td>The minimum of the variable</td> </tr> <tr> <td>2, 3</td> <td>The maximum of the variable</td> </tr> <tr> <td>4, 5</td> <td>The minimum of the mark for the scale; 32-bit integer number</td> </tr> <tr> <td>6, 7</td> <td>The maximum of the mark for the scale; 32-bit integer number</td> </tr> </tbody> </table>	Word	Parameter	0	The minimum of the variable	1	The maximum of the variable	Word	Parameter	0	The minimum of the variable	1	The maximum of the variable	2, 3	The minimum of the mark for the scale; 32-bit integer number	4, 5	The maximum of the mark for the scale; 32-bit integer number	Word	Parameter	0, 1	The minimum of the variable	2, 3	The maximum of the variable	Word	Parameter	0, 1	The minimum of the variable	2, 3	The maximum of the variable	4, 5	The minimum of the mark for the scale; 32-bit integer number	6, 7
Word	Parameter																																
0	The minimum of the variable																																
1	The maximum of the variable																																
Word	Parameter																																
0	The minimum of the variable																																
1	The maximum of the variable																																
2, 3	The minimum of the mark for the scale; 32-bit integer number																																
4, 5	The maximum of the mark for the scale; 32-bit integer number																																
Word	Parameter																																
0, 1	The minimum of the variable																																
2, 3	The maximum of the variable																																
Word	Parameter																																
0, 1	The minimum of the variable																																
2, 3	The maximum of the variable																																
4, 5	The minimum of the mark for the scale; 32-bit integer number																																
6, 7	The maximum of the mark for the scale; 32-bit integer number																																
Minimum		The minimum of the variable to be controlled.																															
Maximum		The maximum of the variable to be controlled.																															
Knob	Border Color	The border color of the knob. To specify the color, click the corresponding Color icon and select a color from the Color palette.																															
	BG Color	The color inside the border. To specify the color, click the corresponding Color icon and select a color from the Color palette.																															

5.6. Setting Word Value Using Word Buttons

You can touch a word button to set a value to the specified variable.

5.6.1. Basic Operations

A word button can be configured to perform one of the following operations:

Operation	Description
Set Constant	Writes the specified constant to the specified variable.
Enter Value	Allows you to enter a value to change the specified variable. The Numeric Keypad displays when the button is pressed and released. After a value is entered with the keypad, the button checks if the value is within the range of the specified minimum and maximum. If the value is valid, the button writes the entered value to the specified variable. If the value is invalid, the operator has to enter another value or quit the operation.
Enter Password	Allows you to enter a value to change the specified variable. The keypad shows the input with a string of asterisks so others cannot know the input value. The Numeric Keypad displays when the button is pressed and released. The keypad shows the operator input with a string of asterisks so others do not know the input value. After a value is entered with the keypad, the button checks if the value is within the range of the specified minimum and maximum. If the value is valid, the button writes the entered value to the specified variable. If the value is invalid, the operator has to enter another value or quit the operation.
Add	Increases the specified variable by the specified constant. If the result of the increase is greater than the specified maximum, the variable is set to the maximum.
Subtract	Decreases the specified variable by the specified constant. If the result of the decrease is less than the specified minimum, the variable is set to the minimum.

5.6.2. Operation Options

The following operation options can be added to a word button to make it more informative, secure, and useful. You need to select and set these options in the Word Button dialog box.

Options	Description
Touch Operation Control	The touch operation can be enabled or disabled either by a specified bit or by the current user level. Select and set this option in the Advanced page.
Minimum Hold Time	The touch operation of the button will not be activated until the button is pressed and held down for the specified time period (Minimum Hold Time). Set this option in the Advanced page.
Operator Confirmation	The Confirmation box will be displayed when the button is touched. If the operator selects "Yes" in the Confirmation box, the button will proceed to perform its operation. If the operator selects "No" or the operator does not respond within the specified time period (Maximum Waiting Time), the button will stop performing its operation. Select and set this option in the Advanced page. Note: that this option is not available for the Enter Password operation.
Notification	The button can be configured to notify a bit upon the completion of the specified operation. Select and set this option in the Advanced page.
Operation Logging	Each touch operation of the button can be recorded in the operation log. Select and set this option in the Advanced page.
Invisible	The button can be invisible and still touch operable. Select this option in the Visibility page.
Visibility Control	The button can be shown or hidden either by a specified bit or by the current user level. Select and set this option in the Visibility page.

5.6.3. Settings

You can complete all the settings of a word button in the Word Button property sheet. This sheet contains the following five pages. Some of the pages appear only when they are needed.

- **General**

Described in [Section 5.6.4.](#)

- **Label**

Described in [Section 4.3.5.](#)

- **Advanced**

Described in [Section 4.4.5.](#)

- **Visibility**

Described in [Section 4.4.6.](#)

- **External Label**

Described in [Section 4.3.8.](#)

5.6.4. General Settings

This section describes how to define the general settings for a word button.



The screenshot shows the 'Word Button' dialog box with the 'General' tab selected. The dialog has a title bar with a close button (X) and four tabs: 'General', 'Label', 'Advanced', and 'Visibility'. The 'General' tab contains the following fields and controls:

- ID:** WB0000
- Note:** (empty text box)
- Picture Shape:** (unchecked)
- External Label:** (unchecked)
- Shape...:** (button)
- VFTA:** Sunken (dropdown menu)
- Test VFTA:** (button)
- Border Color:** (color picker)
- FG Color:** (color picker)
- Pattern:** (pattern picker)
- BG Color:** (color picker)
- Function:**
 - Set Constant
 - Enter Value
 - Enter Password
 - Add
 - Subtract
- Data Type:** 32-Bit Unsigned Int (dropdown menu)
- Write Address:** \$U800 (text box with calculator and help icons)
- Minimum:** 0 (text box)
- Maximum:** 4294967295 (text box)
- Total Digits:** 10 (spin box)
- Fractional Digits:** 0 (spin box)
- Activation:**
 - Button Down
 - Button Up

At the bottom of the dialog are three buttons: 'OK', 'Cancel', and 'Help'.

The above is an example of the General page of the Word Button property sheet.

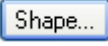
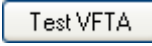
The following table describes each property in the General page.







Property		Description																														
ID		The object's identifier. It is generated when the object is created. The identifier is unique within the screen where the object is located. The format of the IDs for word buttons is WBnnnn.																														
Note		You can type a note for the word button.																														
Shape settings		For details about the following properties, see Section 4.3.4 Setting up the Shape of an Object . Picture Shape,  , VFTA,  , Border Color, Pattern, FG Color, BG Color.																														
External Label		Check this option if you want the word button to have an external label. Set up the external label in the External Label page.																														
Operation		Specifies the operation that the word button performs. For details, see Section 5.6.1 Basic Operations .																														
Data Type		The data type of the variable to be controlled.																														
Write Address	Write Address	Specifies the variable to be controlled.																														
		Click this icon to bring up the Address Input Keypad and specify an address for this property.																														
		Click this icon to bring up the Select Tag dialog box and select a tag for this property.																														
Constant		The constant for the specified operation.																														
Minimum		The minimum for the specified operation.																														
Maximum		The maximum for the specified operation.																														
Total Digits		The number of digits to be displayed for the Minimum and the Maximum on the numeric keypad.																														
Fractional Digits		<p>When the Data Type is 32-bit Floating Point, this property specifies the number of fractional digits to be displayed for the Minimum and Maximum on the numeric keypad.</p> <p>When the Data Type is not 32-bit Floating Point, this property specifies not only the number of fractional digits to be displayed, but also the number of least significant digits to be displayed as the fractional part. With this feature, an integer can be shown and entered as a fixed point number. When the Fractional Digits is nonzero, say N, the entered value will be converted to an integer according to the following formula before being output.</p> $\text{OutputValue} = \text{EnteredValue} * (\text{N}^{\text{th}} \text{ power of } 10)$ <p>Example:</p> <table border="1"> <thead> <tr> <th>Display Type</th> <th>Total Digits</th> <th>Fractional Digits</th> <th>Entered Value</th> <th>Output Value</th> </tr> </thead> <tbody> <tr> <td>32-bit Floating Point</td> <td>4</td> <td>2</td> <td>12.34</td> <td>12.34</td> </tr> <tr> <td>32-bit Floating Point</td> <td>4</td> <td>2</td> <td>123.4</td> <td>Error!</td> </tr> <tr> <td>16-bit Signed Decimal</td> <td>5</td> <td>2</td> <td>123.45</td> <td>12345</td> </tr> <tr> <td>16-bit Signed Decimal</td> <td>5</td> <td>2</td> <td>-0.05</td> <td>-5</td> </tr> <tr> <td>16-bit Signed Decimal</td> <td>5</td> <td>2</td> <td>3</td> <td>300</td> </tr> </tbody> </table>	Display Type	Total Digits	Fractional Digits	Entered Value	Output Value	32-bit Floating Point	4	2	12.34	12.34	32-bit Floating Point	4	2	123.4	Error!	16-bit Signed Decimal	5	2	123.45	12345	16-bit Signed Decimal	5	2	-0.05	-5	16-bit Signed Decimal	5	2	3	300
Display Type	Total Digits	Fractional Digits	Entered Value	Output Value																												
32-bit Floating Point	4	2	12.34	12.34																												
32-bit Floating Point	4	2	123.4	Error!																												
16-bit Signed Decimal	5	2	123.45	12345																												
16-bit Signed Decimal	5	2	-0.05	-5																												
16-bit Signed Decimal	5	2	3	300																												
Activation	Button Down	Select this item so the touch operation will be activated when the button is touched.																														
	Button Up	Select this item so the touch operation will be activated when the button is released.																														
Key		The hard key that is used to operate the word button. This item is available when the target panel has hard keys.																														

5.7. Selecting Work Value Using Multi-state Switches



You can use a multi-state switch to change the state of the specified variable.

5.7.1. Basic Operations

A multi-state switch can be configured to perform as one of the following types of controls:

Control Type	Description
Button	The multi-state switch is a push button. It changes the state of the specified variable to the next state when it is touched. Note: that the next state is not necessarily the current state plus one.
List	<p>The multi-state switch is a list box. It lists the text of all the states of the switch one state per line starting from state 0 as shown in the example on the right.</p> <p>The text of the current state is highlighted. If the desired state is not in view, you can use the scroll bar attached to the right side of the list box to scroll the text. When you select a desired state by touching its text, the list box writes the value of the selected state to the specified variable.</p> 
Drop-down List	<p>The multi-state switch is a drop-down list. It displays the text of the current state and a button with the down arrow symbol as shown in the following example.</p>  <p>When the button is touched, the switch list displays a list box beneath itself as shown in the following example.</p>  <p>The list box lists the text of all states of the switch one state per line starting from state 0. The text of the current state is highlighted. If the desired state is not in view, you can use the scroll bar attached to the right side of the list to scroll the text. When you select a desired state by touching its text, the switch writes the value of the selected state to the specified variable and closes the list box.</p>    <p>If you want to cancel the operation when the list box is showing, touch anywhere other than the text in the list box.</p>

Continued

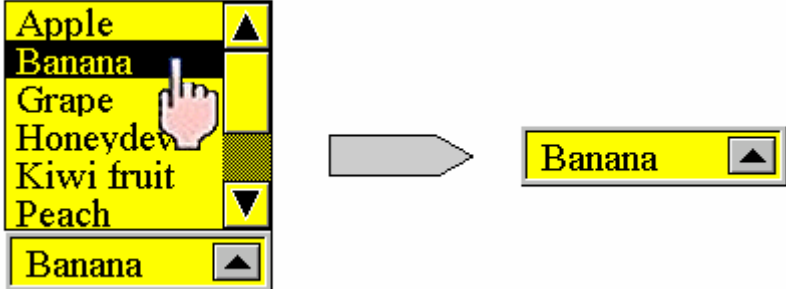
Control Type	Description
Throw-up List	<p>The multi-state switch is a throw-up list. It displays the text of the current state and a button with the up arrow symbol as shown in the following example.</p>  <p>When the button is touched, the switch list displays a list box above itself as shown in the following example.</p>  <p>The list box lists the text of all states of the switch one state per line starting from state 0. The text of the current state is highlighted. If the desired state is not in view, you can use the scroll bar attached to the right side of the list to scroll the text. When you select a desired state by touching its text, the switch writes the value of the selected state to the specified variable and closes the list box.</p>  <p>If you want to cancel the operation when the list box is showing, touch anywhere other than the text in the list box.</p>

5.7.2. Operation Options

The following operation options can be added to a multi-state switch to make it more informative, secure, and useful. You need to select and set these options in the Multi-state Switch dialog box.

Options	Description
Touch Operation Control	The touch operation can be enabled and disabled either by a specified bit or by the current user level. Select and set this option in the Advanced page.
Minimum Hold Time	The touch operation of the switch will not be activated until the switch is pressed and held down for the specified time period (Minimum Hold Time). Set this option in the Advanced page.
Notification	The switch can be configured to notify a bit of the completion of the specified operation. Select and set this option in the Advanced page.
Operation Logging	Each data change performed by the switch can be recorded in the operation log. Select and set this option in the Advanced page.
Invisible	The switch can be invisible and still touch operable. Select this option in the Visibility page.
Visibility Control	The switch can be shown or hidden either by a specified bit or by the current user level. Select and set this option in the Visibility page.

5.7.3. Settings

You can complete all the settings of a multi-state switch in the Multi-state Switch dialog box. This dialog box contains the following six pages. Some of the pages appear only when they are needed.

- **General**

Described in [Section 5.7.4.](#)

- **Text**

Described in [Section 4.3.6.](#)

- **Picture**

Described in [Section 4.3.7.](#)

- **Advanced**

Described in [Section 4.4.5.](#)

- **Visibility**

Described in [Section 4.4.6.](#)

- **External Label**

Described in [Section 4.3.8.](#)

5.7.4. General Settings



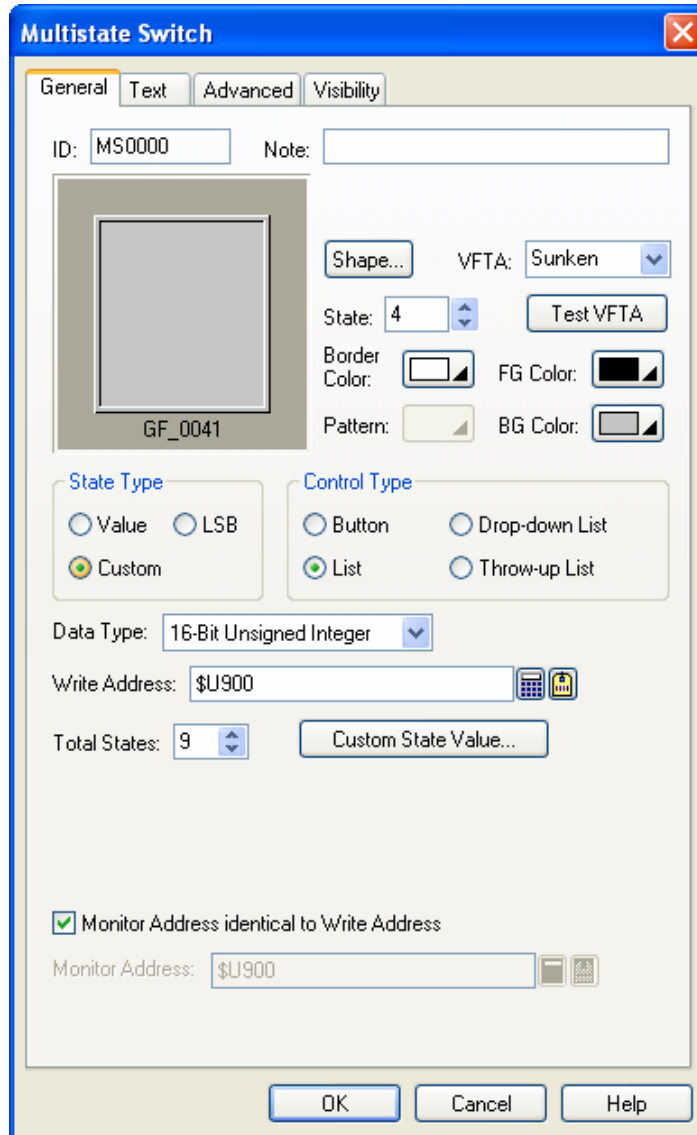

This section describes how to define the general settings for a multi-state switch. The following is an example of the General page of the Multi-state Switch property sheet.



The following table describes each property in the General page.

Property	Description
ID	The object's identifier. It is generated when the object is created. The identifier is unique within the screen where the object is located. The format of the IDs for multi-state switch is MSnnnn.
Note	You can type a note for the multi-state switch.
Shape settings	For details about the following properties, see Section 4.3.4 Setting up the Shape of an Object . Picture Shape, <input type="button" value="Shape..."/> , VFTA, <input type="button" value="Test VFTA"/> , Border Color, Pattern, FG Color, BG Color
External Label	Check this option if you want the multi-state switch to have an external label. Set up the external label in the External Label page.

Continued

Property		Description
State		The current state of the multi-state switch that you can view and set the object appearance for.
State Type		The state type of the monitored variable. There are two options: Value and LSB. For details, see Section 4.4.1.1 State Types .
Control Type		Specifies the control type that the multi-state switch will perform as. There are three types you can choose: Button, List, and Drop-down List, Throw-up List. For details, see Section 5.7.1 Basic Operations .
Data Type		The data type of the variables specified in this page.
Write Address	Write Address	Specifies the variable to be controlled.
		Click this icon to bring up the Address Input Keypad and specify an address for this property.
		Click this icon to bring up the Select Tag dialog box and select a tag for this property.
Total States		Specifies the number of valid states that the monitored variable has. Note: The last state is state N-1 when the Total States is N.
Next State		Specifies the method of calculating the next state for the Button control type.
	+1 (Wrap)	The next state is the current state plus one when the current state is not the last state. When the current state is the last state, the next state is state 0.
	-1 (Wrap)	The next state is the current state minus one when the current state is not state 0. When the current state is state 0, the next state is the last state.
	+1/-1 (Retreat)	With this method, the switch is either in the increasing mode or in the decreasing mode for the next state calculation. The switch is in the increasing mode initially. Assume that the total states of the switch is N. When the switch is in the increasing mode, the next state is the current state plus one, if the current state is not the last state, i.e. state N-1. If the current state is the last state, the switch changes into the decreasing mode, and the next state is the current state minus one, i.e. state N-2. When the switch is in the decreasing mode, the next state is the current state minus one if the current state is not state 0. If the current state is state 0, the switch changes into the increasing mode and the next state is the current state plus one, i.e. state 1.
Activation		Specifies how the multi-state switch is activated for the Button control type.
	Direct	The multi-state switch is activated when the button is touched.
	Indirect	The multi-state switch is activated when it is selected, and a function button on the same screen with the operation of “Increase Value By One” or “Decrease Value y One” is touched.
Monitor Address identical to Write Address		Specifies that the Monitor Address is identical to the Write Address. With this item checked, you don’t need to specify the same variable for the Monitor Address field.
Monitor Address	Monitor Address	Specifies the variable to be monitored.
		Click this icon to bring up the Address Input Keypad and specify an address for the Monitor Address field.
		Click this icon to bring up the Select Tag dialog box and select a tag for the Monitor Address field.
Key		The hard key that is used to operate the multi-state switch. This item is available when the target panel has hard keys.

5.8. Setting Word State Using Radio Button Groups

You can press a button of a radio button group to change the state of the controlled variable.

5.8.1. Basic Operations

A radio button group has as many radio buttons as the number of states it has. Each radio button corresponds to a state. When a radio button is pressed, the value of that button's associated state is written to the controlled variable. The state of a radio button group is determined by the state of the controlled variable. A radio button is highlighted when its associated state is the current state.

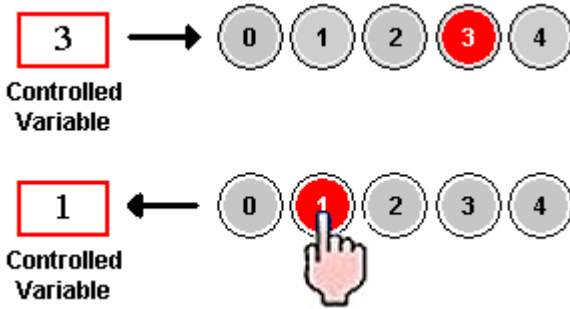

5.8.2. Operation Options

The following operation options can be added to a radio button group to make it more informative, secure, and useful. You need to select and set these options in the Radio Button Group dialog box.

Options	Description
Touch Operation Control	The touch operation of the radio button group can be enabled and disabled either by a specified bit or by the current user level. Select and set this option in the Advanced page.
Minimum Hold Time	The touch operation will not be activated until a button of the radio button group is pressed and held down for the specified time period (Minimum Hold Time). Set this option in the Advanced page.
Operation Logging	Each data change performed by the radio button group can be recorded in the operation log. Select and set this option in the Advanced page.
Visibility Control	The radio button group can be shown or hidden either by a specified bit or by the current user level. Select and set this option in the Visibility page.

5.8.3. Settings

You can complete all the settings of a radio button group in the Radio Button Group dialog box. This dialog box contains the following six pages. Some of the pages appear only when they are needed.

- **General**

Described in [Section 5.8.4.](#)

- **Text**

Described in [Section 4.3.6.](#)

- **Picture**

Described in [Section 4.3.7.](#)

- **Advanced**

Described in [Section 4.4.5.](#)

- **Visibility**

Described in [Section 4.4.6.](#)

- **External Label**



Described in [Section 4.3.8.](#)

5.8.4. General Settings

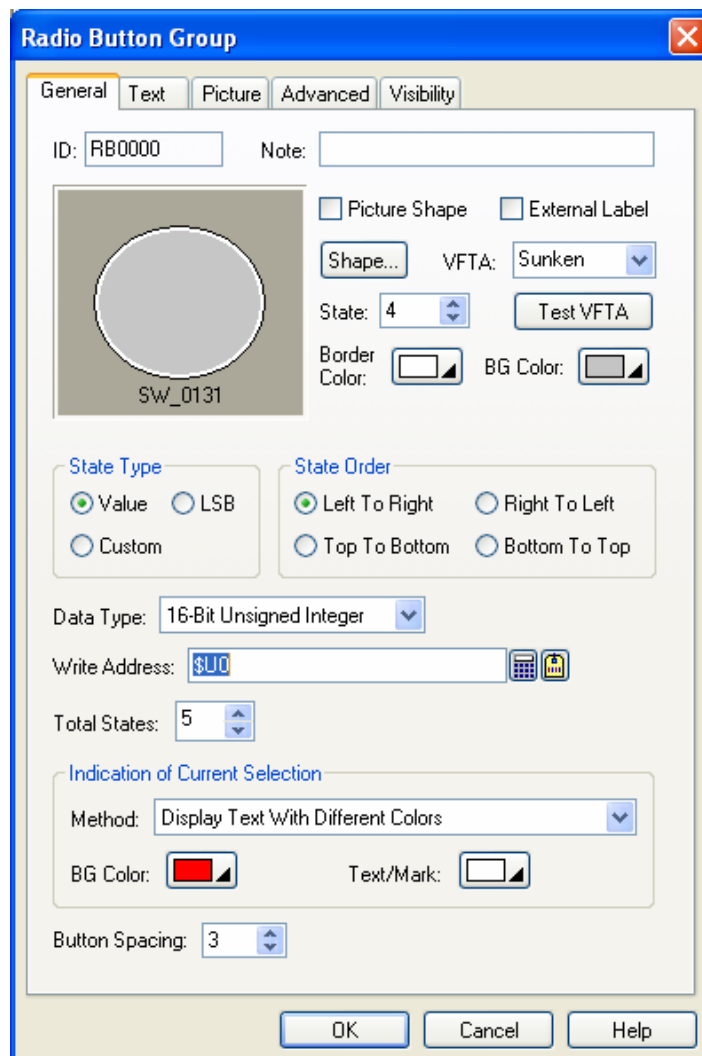
This section describes how to define the general settings for a radio button group. The following is an example of the General page of the Radio Button Group property sheet.

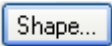
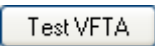

The following table describes each property in the General page.

Property		Description										
ID		The object's identifier. It is generated when the object is created. The identifier is unique within the screen where the object is located. The format of the IDs for radio button groups is RBnnnn.										
Note		You can type a note for the radio button group.										
Shape settings		For details about the following properties, Section 4.3.4 Setting up the Shape of an Object . Picture Shape,  , VFTA,  , Border Color, BG Color										
External Label		Check this option if you want the radio button group to have an external label. Set up the external label in the External Label page.										
State		Specifies the current state of the radio button group. You can set the appearance of the button associated with the current state. Note: Although you can set the appearance for the button of the current state, you cannot view all the changes immediately. This is because the button is highlighted with the BG color and the text color set for the Current State. You can change the current state so the button is shown with new settings instead of being highlighted.										
State Type		The state type of the controlled variable. There are three options: Value, LSB, and Custom. For details, see Section 4.4.1.1 State Types .										
State Order		Specifies how to arrange the radio buttons. There are four kinds of order: <table border="1" data-bbox="381 909 1481 1249"> <thead> <tr> <th>State Order</th> <th>Description</th> </tr> </thead> <tbody> <tr> <td>Left to Right</td> <td>The buttons are arranged in order, in a row with the button of state 0 at the left most position.</td> </tr> <tr> <td>Right to Left</td> <td>The buttons are arranged in order, in a row with the button of state 0 at the right most position.</td> </tr> <tr> <td>Top to Bottom</td> <td>The buttons are arranged in order, in a column with the button of state 0 at the top position.</td> </tr> <tr> <td>Bottom to Top</td> <td>The buttons are arranged in order, in a column with the button of state 0 at the bottom position.</td> </tr> </tbody> </table>	State Order	Description	Left to Right	The buttons are arranged in order, in a row with the button of state 0 at the left most position.	Right to Left	The buttons are arranged in order, in a row with the button of state 0 at the right most position.	Top to Bottom	The buttons are arranged in order, in a column with the button of state 0 at the top position.	Bottom to Top	The buttons are arranged in order, in a column with the button of state 0 at the bottom position.
State Order	Description											
Left to Right	The buttons are arranged in order, in a row with the button of state 0 at the left most position.											
Right to Left	The buttons are arranged in order, in a row with the button of state 0 at the right most position.											
Top to Bottom	The buttons are arranged in order, in a column with the button of state 0 at the top position.											
Bottom to Top	The buttons are arranged in order, in a column with the button of state 0 at the bottom position.											
Data Type		The data type of the variables specified in this page.										
Write Address	Write Address	Specifies the variable to be controlled.										
		Click this icon to bring up the Address Input Keypad and specify an address for this property.										
		Click this icon to bring up the Select Tag dialog box and select a tag for this property.										
Total States		Specifies the number of valid states that the controlled variable has.										
Indication of Current Selection	Method	Choose the method from display text with different colors, use round mark or use square mark to indicate the current selection.										
	BG Color	The color to replace the shape's BG color when selected.										
	Text / Mark	The color to replace the text or mark color when selected.										
Button Spacing		The distance in pixels between two adjacent radio buttons.										
Custom State Value		Click this button to define the state value for each state when the State Type is Custom. For details, see Section 4.4.1.2 Setting the Custom States of an Object .										

5.9. Customizing the Keypad Using Keypad Buttons

A keypad button inputs a character to the keypad buffer or issues a command to the keypad buffer when it is pressed. You can use keypad buttons to create your own keypads.

5.9.1. Operation Options

The following operation options can be added to a keypad button to make it more useful. You need to select and set these options in the Keypad Button dialog box.

Options	Description
Macro	The keypad button can have a macro to execute when being pressed. Specify and edit the macro in the Macro page.
Visibility Control	The keypad button can be shown or hidden either by a specified bit or by the current user level. Select and set this option in the Visibility page.

5.9.2. Settings

You can complete all the settings of a keypad button in the Keypad Button dialog box. This dialog box contains the following four pages. Some of the pages appear only when they are needed.

- **General**

Described in [Section 5.9.3.](#)

- **Label**

Described in [Section 4.3.5.](#)

- **Visibility**

Described in [Section 4.4.6.](#)

- **Macro**

Described in [Section 14.2.6.](#)

5.9.3. General Settings

This section describes how to define the general settings for a keypad button. The following is an example of the General page of the Keypad Button property sheet.

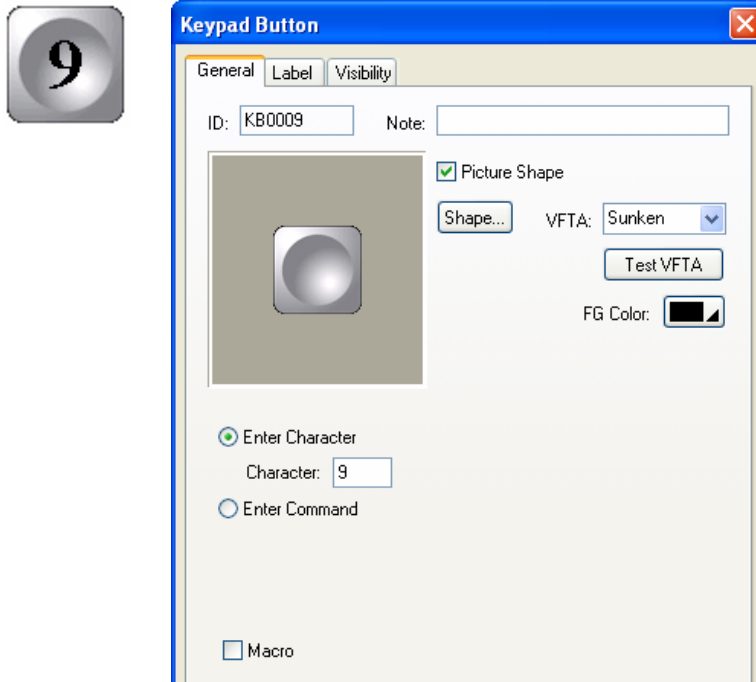

The following table describes each property in the General page.

Property	Description										
ID	The object's identifier. It is generated when the object is created. The identifier is unique within the screen where the object is located. The format of the IDs for keypad buttons is KBnnnn.										
Note	You can type a note for the keypad button group.										
Shape settings	For details about the following properties, see Section 4.3.4 Setting up the Shape of an Object . Picture Shape, <input type="button" value="Shape..."/> , VFTA, <input type="button" value="Test VFTA"/> , Border Color, Pattern Color, FG Color, BG Color										
Enter Character	Select this item if the button is used to input the specified character to the keypad buffer.										
Character	Available when Enter Character is selected. Specifies the character to be entered in the keypad buffer.										
Enter Command	Select this item if the button is used to issue the specified command to the keypad buffer.										
Command	Available when Enter Command is selected. Specifies the command to be issued to the keypad buffer. There are four commands available: <table border="1"> <thead> <tr> <th>Command</th> <th>Description</th> </tr> </thead> <tbody> <tr> <td>Enter</td> <td>Completes data entry and sends the input string to the associated object or the system.</td> </tr> <tr> <td>Escape</td> <td>Cancels the data entry operation.</td> </tr> <tr> <td>Clear</td> <td>Clears the keypad buffer.</td> </tr> <tr> <td>Backspace</td> <td>Removes the last character in the keypad buffer.</td> </tr> </tbody> </table>	Command	Description	Enter	Completes data entry and sends the input string to the associated object or the system.	Escape	Cancels the data entry operation.	Clear	Clears the keypad buffer.	Backspace	Removes the last character in the keypad buffer.
Command	Description										
Enter	Completes data entry and sends the input string to the associated object or the system.										
Escape	Cancels the data entry operation.										
Clear	Clears the keypad buffer.										
Backspace	Removes the last character in the keypad buffer.										
Key	The hard key that is used to operate the keypad button. This item is available only when the target panel has hard keys.										
Macro	Check this option if you want the button to have a macro. Specify and edit the macro in the Macro page.										

5.9.4. Creating your own keypads

You can create your own keypads using keypad buttons as custom keypads for your application. The following is an example of a custom numeric keypad.

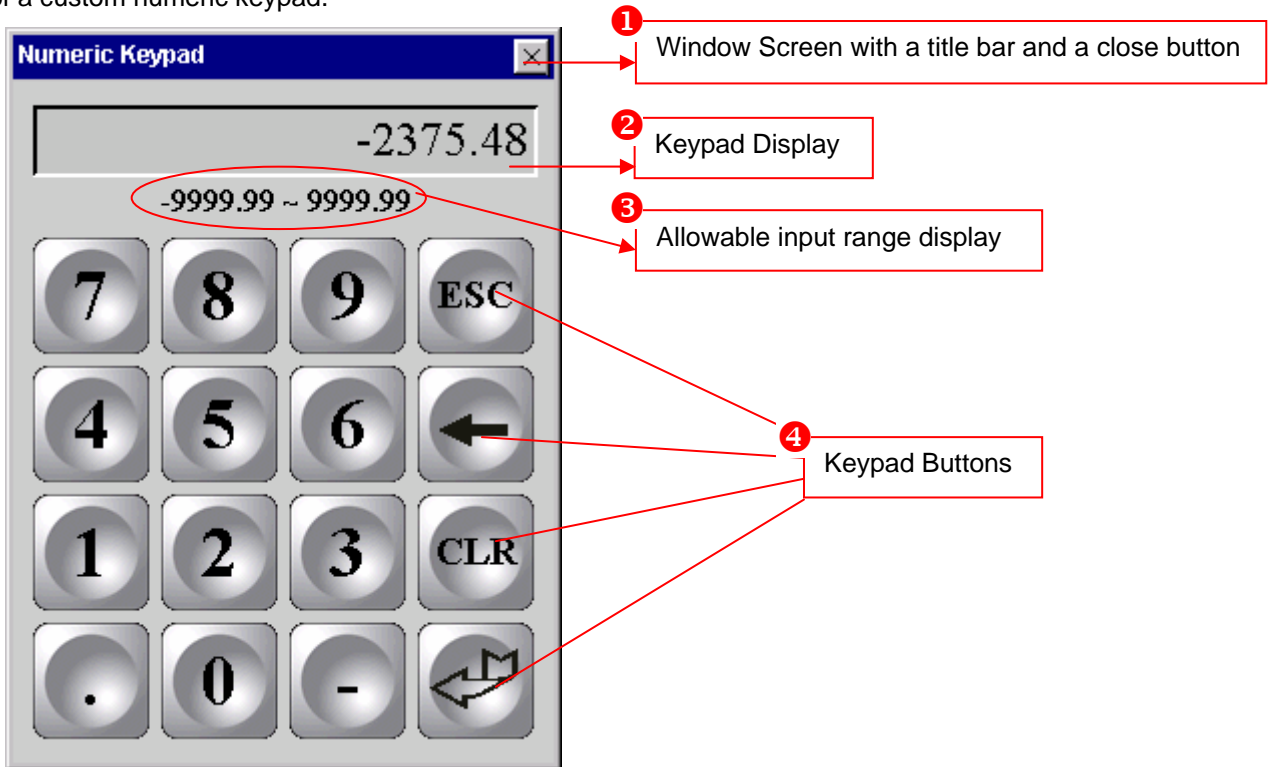

To create your own keypads, please do the following:

1. Create a window screen, please see [Section 3.9.2 Creating and Opening Screens](#) for details.
2. Create a Character Display with the following settings to display characters when the keypad button is pressed.

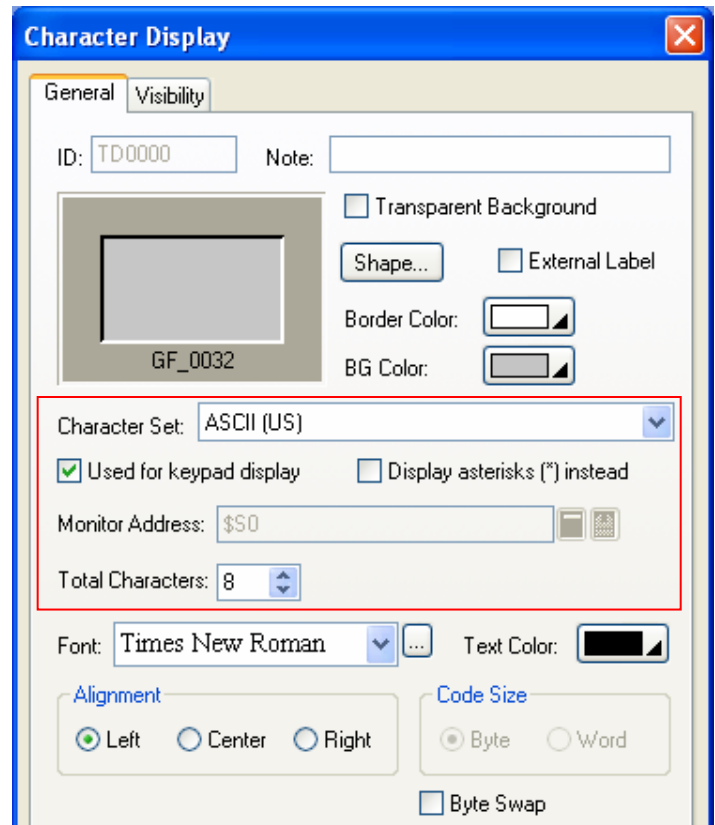
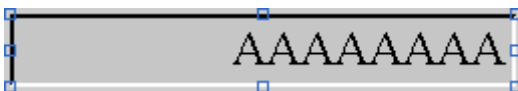

3. Create a Character Display with the following settings to display an allowable input range.



Note:

Monitor Address: \$S230
 Total Characters: 24 (or less)
 Font: Any font
 Alignment: Any (Center recommended)
 Character Set: ASCII code (7 bits)
 Code Size: Byte

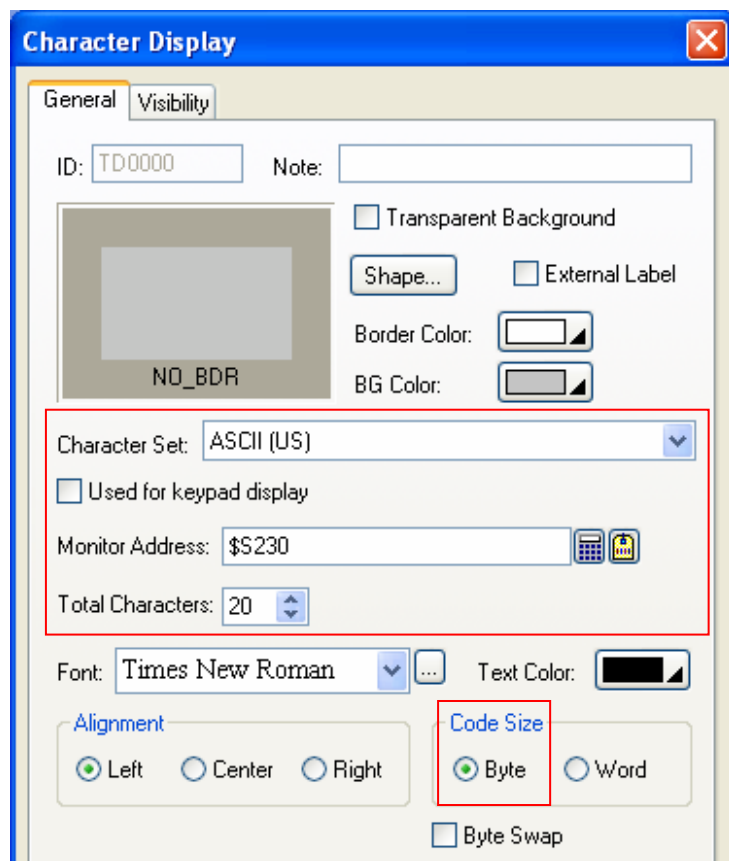







4. Create keypad buttons to customize the keypad.
5. Set up the Custom page of the General Setup dialog box to use the custom keypad instead of the built-in keypad. Please see [Section 3.1.2 Custom Settings](#) for details.

5.10. Scrolling Object Content Using Scroll Button Groups







You can use the buttons of a scroll button group to scroll the content displayed by the associated object.

5.10.1. Basic Operations

A scroll button group with the horizontal button alignment can have the following buttons:

Button	Example	Description
Scroll to Right End		Scrolls the content displayed by the associated object to the right end.
Scroll Page Right		Scrolls the content displayed by the associated object to the right by one page.
Scroll Right		Scrolls the content displayed by the associated object to the right.
Scroll Left		Scrolls the content displayed by the associated object to the left.
Scroll Page Left		Scrolls the content displayed by the associated object to the left by one page.
Scroll to Left End		Scrolls the content displayed by the associated object to the left end.
Pause		This is a toggle switch. It stops the auto-scrolling of the content displayed by the associated object when it is touched. When you touch it again, it resumes the auto-scrolling operation.

A scroll button group with the vertical button alignment can have the following buttons:

Button	Example	Description
Scroll to Top End		Scrolls the content displayed by the associated object to the top end.
Scroll Page Up		Scrolls the content displayed by the associated object to the top by one page.
Scroll Up		Scrolls the content displayed by the associated object to the top.
Scroll Down		Scrolls the content displayed by the associated object to the bottom.
Scroll Page Down		Scrolls the content displayed by the associated object to the bottom by one page.
Scroll to Bottom End		Scrolls the content displayed by the associated object to the bottom end.
Pause		This is a toggle switch. It stops the auto-scrolling of the content displayed by the associated object when it is touched. When you touch it again, it resumes the auto-scrolling operation.

5.10.2. Operation Options

The following operation option can be added to a scroll button group. You need to select and set this option in the Scroll Button Group dialog box.

Options	Description
Visibility Control	The scroll button group can be shown or hidden either by a specified bit or by the current user level. Select and set this option in the Visibility page.

5.10.3. Settings

You can complete all the settings of a scroll button group in the Scroll Button Group dialog box. This dialog box contains the following two pages.

- **General**

Described in [Section 5.10.4.](#)

- **Visibility**

Described in [Section 4.4.6.](#)

5.10.4. General Settings

This section describes how to define the general settings for a scroll button group. The following is an example of the General page of the Scroll Button Group property sheet.

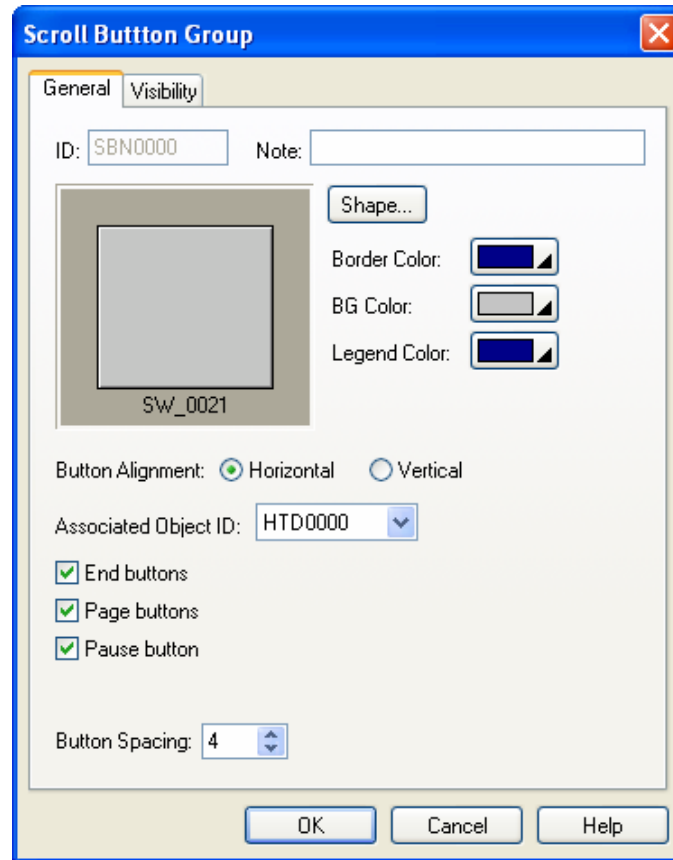

The following table describes each property in the General page.

Property		Description
ID		The object's identifier. It is generated when the object is created. The identifier is unique within the screen where the object is located. The format of the IDs for the scroll button groups is SBNnnnn.
Note		You can type a note for the scroll button group.
Shape settings		For details about the following properties, Section 4.3.4 Setting up the Shape of an Object , Shape... , Border Color, BG Color
Legend Color		The color of the legend for every button of the scroll button group.
Button Alignment	Horizontal	The buttons of the scroll button group are aligned in a row.
	Vertical	The buttons of the scroll button group are aligned in a column.
Associated Object ID		The ID of the object that the scroll button group will be used to scroll its content. You can select the associated object from this drop-down list which displays the IDs of objects on the same screen that support the scroll operation.
Start/End buttons		Check this item if you want the scroll button group to include the buttons that scroll the content to the start or to the end.
Scroll Page buttons		Check this item if you want the scroll button group to include the buttons that scroll the content each time by one page.
Pause button		Check this item if you want the scroll button group to include the Pause button.
Button Spacing		The distance in pixels between two adjacent buttons.

5.11. Scrolling Object Content Using Scroll Bars

You can use a scroll bar to scroll the content displayed by the associated object. The associated objects include Historic Data Display, Historic Message Display, Historic Trend Display, Operation Log Display, Alarm Display, Recipe Table, and Sub-link Table.

5.11.1. Basic Operations

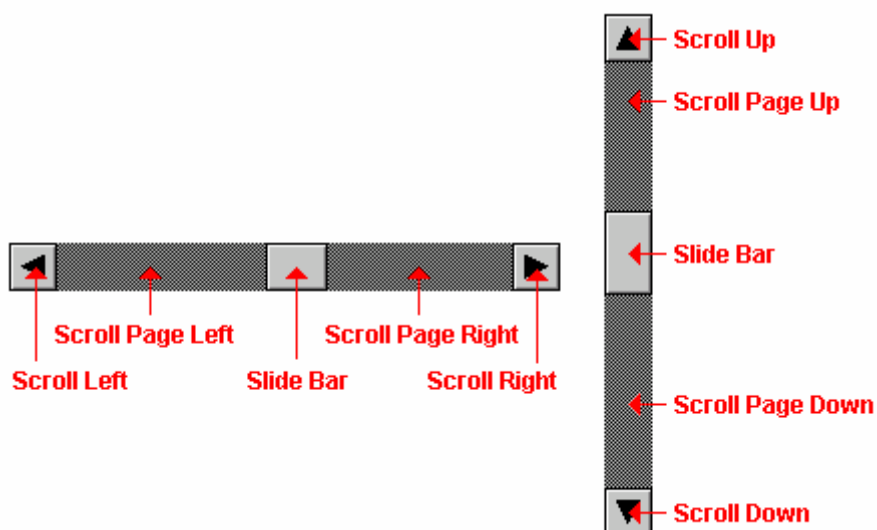

A horizontal scroll bar has the following buttons:

Button	Description
Scroll Right	Scrolls the content displayed by the associated object to the right.
Scroll Page Right	Scrolls the content displayed by the associated object to the right by one page.
Slide Bar	You can push and move the slide bar to scroll the content displayed by the associated object. The content is scrolled in the same direction as you move the slide bar. The amount of scrolling is proportional to the displacement of the slide bar. The position of the slide bar in the scroll bar indicates the position of the viewable part of the content. The width of the slide bar indicates how much of the content is viewable.
Scroll Page Left	Scrolls the content displayed by the associated object to the left by one page.
Scroll Left	Scrolls the content displayed by the associated object to the left.

A vertical scroll bar has the following buttons:

Button	Description
Scroll Up	Scrolls the content displayed by the associated object to the top.
Scroll Page Up	Scrolls the content displayed by the associated object to the top by one page.
Slide Bar	You can push and move the slide bar to scroll the content displayed by the associated object. The content is scrolled in the same direction as you move the slide bar. The amount of scrolling is proportional to the displacement of the slide bar. The position of the slide bar in the scroll bar indicates the position of the viewable part of the content. The height of the slide bar indicates how much of the content is viewable.
Scroll Page Down	Scrolls the content displayed by the associated object to the bottom by one page.
Scroll Down	Scrolls the content displayed by the associated object to the bottom.

5.11.2. Operation Options

The following operation option can be added to a scroll bar. You need to select and set this option in the Scroll Bar property sheet.

Options	Description
Visibility Control	The scroll bar can be shown or hidden either by a specified bit or by the current user level. Select and set this option in the Visibility page.

5.11.3. Settings

You can complete all the settings of a scroll bar in the Scroll Bar property sheet. This sheet contains the following two pages.

- **General**

Described in [Section 5.11.4.](#)

- **Visibility**

Described in [Section 4.4.6.](#)

5.11.4. General Settings

This section describes how to define the general settings for a scroll bar. The following is an example of the General page of the Scroll Bar property sheet.

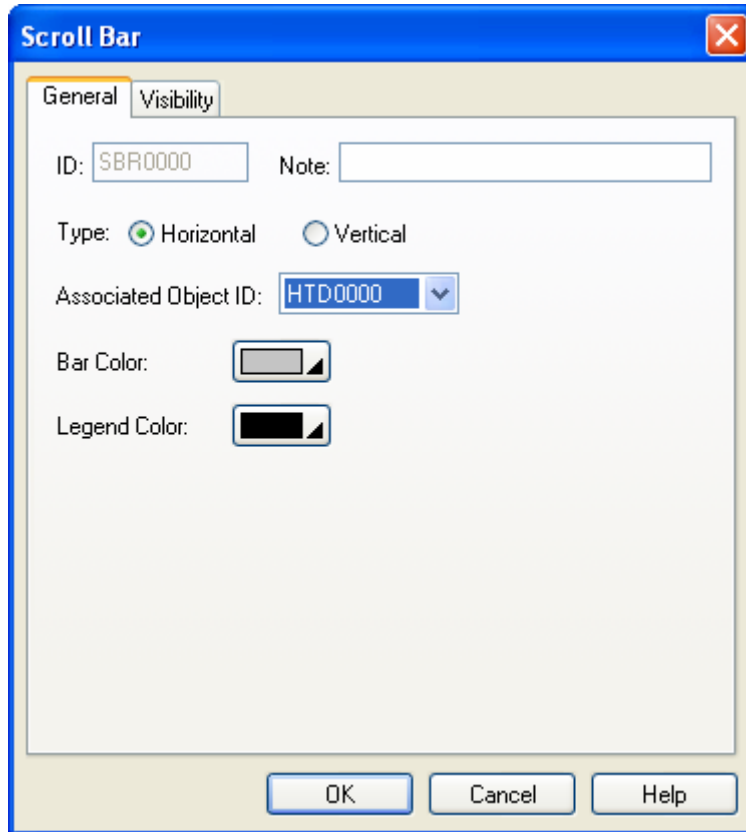

The following table describes each property in the General page.

Property	Description
ID	The object's identifier. It is generated when the object is created. The identifier is unique within the screen where the object is located. The format of the IDs for the scroll bars is SBRnnnn.
Note	You can type a note for the scroll button group.
Type	The type of scroll bar. There are two types; horizontal and vertical.
Associated Object ID	The ID of the object that will use the scroll bar to scroll its content. You can select the associated object from this drop-down list which shows the IDs of objects on the same screen that support the scroll operation.
Bar Color	The color of the scroll bar.
Legend Color	The color of the legend for the buttons of the scroll bar.

5.12. Stepping Through Word State Using Step Buttons

You can press a step button to write the value of the button's next state to the specified variable.

5.12.1. Basic Operations

Unlike most of the other objects, a step button displays all the states at once, with the current state highlighted, instead of displaying just the current state. A step button can let the operators know all the available states, and what the next state will be when they touch it.

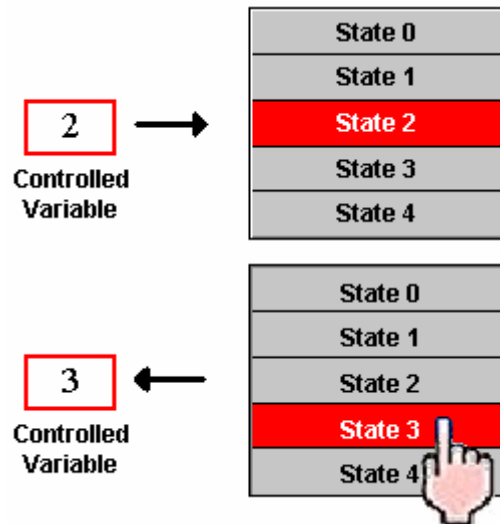

The state of a step button is determined by the value of the specified variable and the specified state type. When a step button is pressed, it calculates the value of the next state, and writes that value to the specified variable. The next state is the current state plus one, when the current state is not the last state. When the current state is the last state, the next state is state 0.

5.12.2. Operation Options

The following operation options can be added to a step button to make it more informative, secure, and useful. You need to select and set these options in the Step Button property sheet.

Options	Description
Touch Operation Control	The touch operation of the step button can be enabled and disabled either by a specified bit or by the current user level. Select and set this option in the Advanced page.
Minimum Hold Time	The touch operation will not be activated until the step button is pressed and held down for the specified time period (Minimum Hold Time). Set this option in the Advanced page.
Operation Logging	Each data change performed by the step button can be recorded in the operation log. Select and set this option in the Advanced page.
Visibility Control	The step button can be shown or hidden either by a specified bit or by the current user level. Select and set this option in the Visibility page.

5.12.3. Settings

You can complete all the settings of a step button in the Step Button property sheet. This sheet contains the following six pages. Some of the pages appear only when they are needed.

- **General**

Described in [Section 5.12.4.](#)

- **Text**

Described in [Section 4.3.6.](#)

- **Picture**

Described in [Section 4.3.7.](#)

- **Advanced**

Described in [Section 4.4.5.](#)

- **Visibility**

Described in [Section 4.4.6.](#)

- **External Label**

Described in [Section 4.3.8.](#)

5.12.4. General Settings

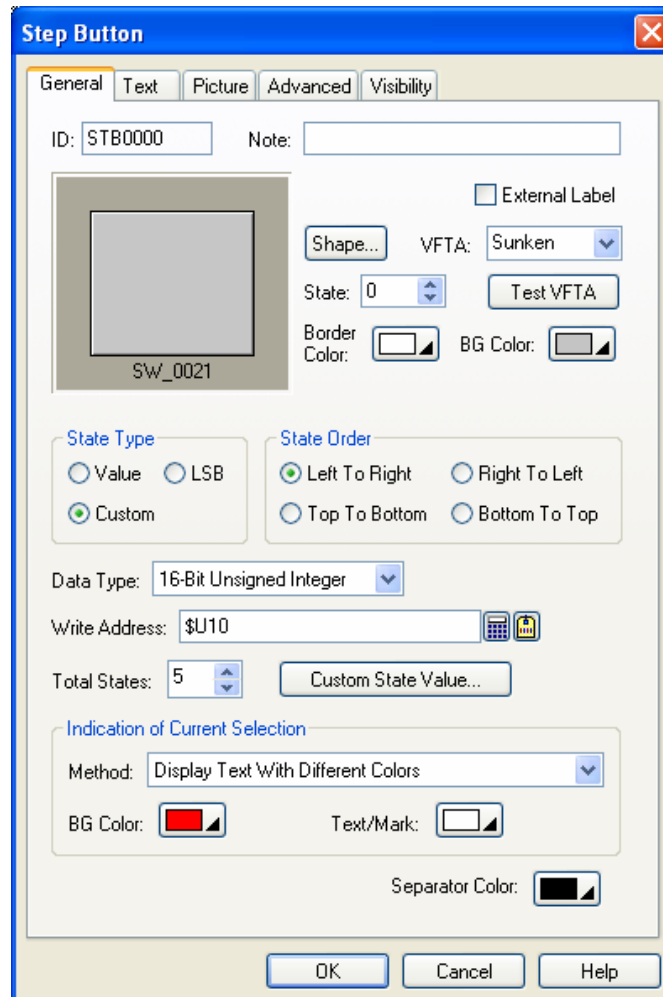

This section describes how to define the general settings for a step button. The following is an example of the General page of the Step Button property sheet.

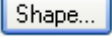
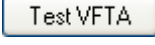
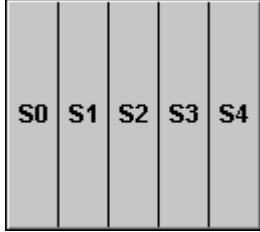
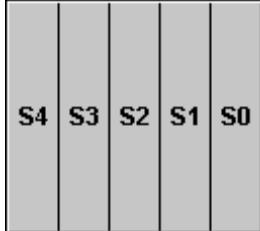
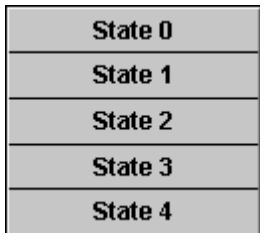
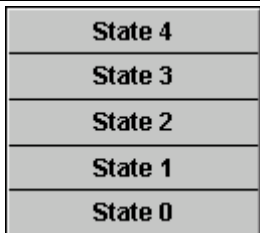
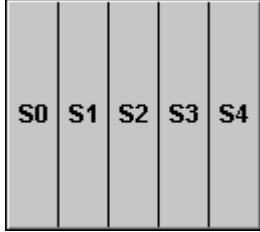
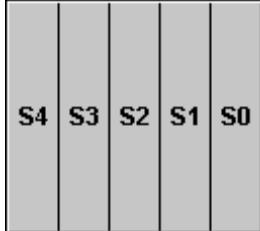
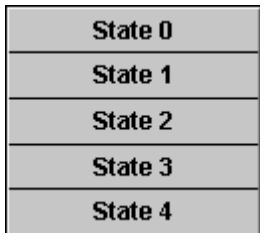
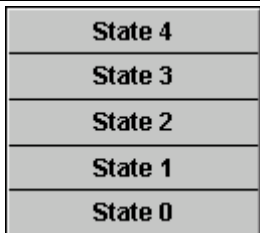
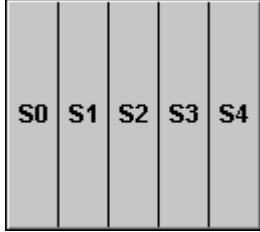
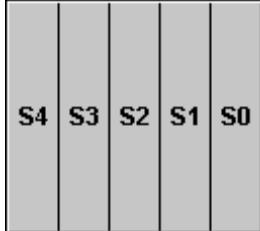
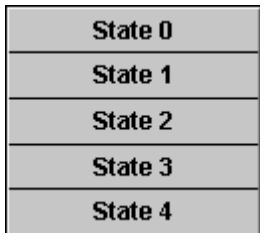
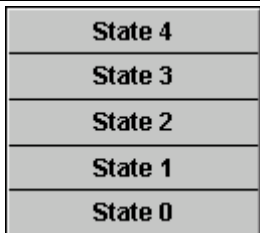

The following table describes each property in the General page.

Property	Description										
ID	The object's identifier. It is generated when the object is created. The identifier is unique within the screen where the object is located. The format of the IDs for the step buttons is STBnnnn.										
Note	You can type a note for this object.										
Shape settings	For details about the following properties, Section 4.3.4 Setting up the Shape of an Object .  , VFTA,  , Border Color, BG Color										
External Label	Check this option if you want the object to have an external label. Set up the external label in the External Label page.										
State	Select a state as the current state so you can set the BG Color for that state. You can also see how the step button looks when the selected state is highlighted. Note: The current state is always highlighted by the settings defined in the Highlight Current State group. Therefore, you cannot see the change of the BG color you made for the current state immediately. To see the change, select another state as the current state.										
State Type	The state type of the step button. The supported types are: Value, LSB, and Custom. For details, see Section 4.4.1.1 State Types										
State Order	Specifies how to arrange the states on the step button. There are four different orders: <table border="1" data-bbox="363 824 1050 1848"> <thead> <tr> <th>State Order</th> <th>Example</th> </tr> </thead> <tbody> <tr> <td>Left to Right</td> <td>  </td> </tr> <tr> <td>Right to Left</td> <td>  </td> </tr> <tr> <td>Top to Bottom</td> <td>  </td> </tr> <tr> <td>Bottom to Top</td> <td>  </td> </tr> </tbody> </table>	State Order	Example	Left to Right		Right to Left		Top to Bottom		Bottom to Top	
State Order	Example										
Left to Right											
Right to Left											
Top to Bottom											
Bottom to Top											
Data Type	The data type for the variable in the Write Address field. The supported types are: 16-bit Unsigned Integer, 16-bit BCD, 32-bit Unsigned Integer, and 32-bit BCD.										

Continued

Property		Description
Write Address	Write Address	Specifies the variable to be controlled by the step button. This variable will also be monitored to decide the state of the step button.
		Click this icon to bring up the Address Input Keypad and specify an address for this property.
		Click this icon to bring up the Select Tag dialog box and select a tag for this property.
Total States		Specifies the number of states that the step button can display and process.
Custom State Value...		Click this button to define the state value for each state of the step button when the State Type is Custom. For details, see Section 4.4.1.2 Setting the Custom States of an Object .
Indication of current selection	Method	Choose the method from display text with different colors, use round mark or use square mark to indicate the current selection.
	BG Color	The color to replace the shape's BG color when selected.
	Text/Mark	The color to replace the text or mark color when selected.
Separator Color		The color of the lines that are drawn between two states.

5.13. Displaying Window Screen as Information Page Using Page Selectors

In a page selector, you can press a tab to view the associated page (window screen).

5.13.1. Basic Operations

You can configure a page selector to contain up to 8 window screens. Each of the specified window screens is a page, and each page has an associated tab. You can specify the text and picture for each tab. At runtime, a page selector shows one of the specified pages in its viewing area. You can select a desired page to view by pressing the associated tab.

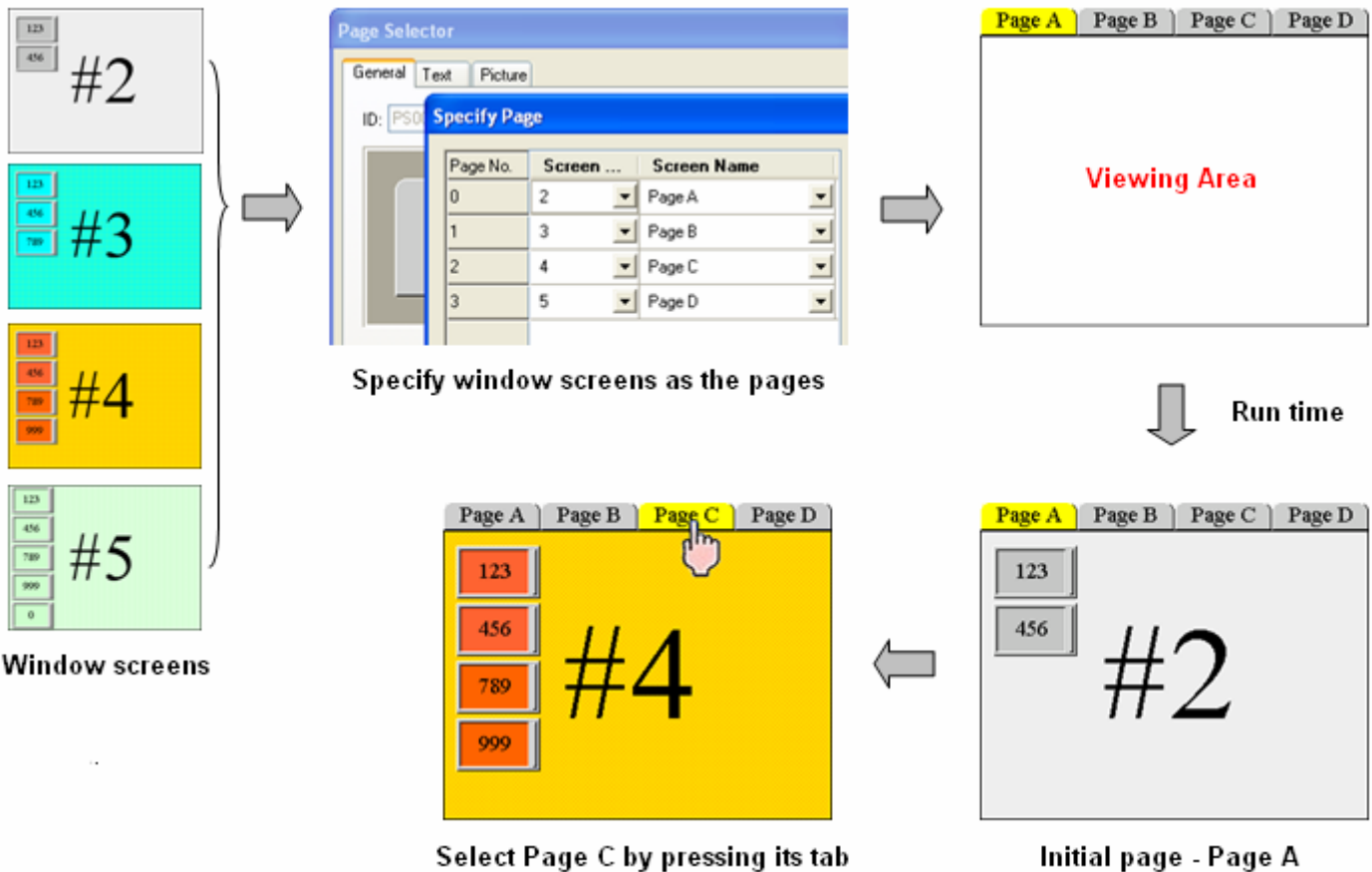

5.13.2. Settings

You can complete all the settings of a page selector in the Page Selector property sheet. This sheet contains the following three pages.

- **General**
Described in [Section 5.13.3](#).
- **Text**
Described in [Section 4.3.6](#).
- **Picture**
Described in [Section 4.3.7](#).

5.13.3. General Settings

This section describes how to define the general settings for a page selector. The following is an example of the General page of the Page Selector property sheet.

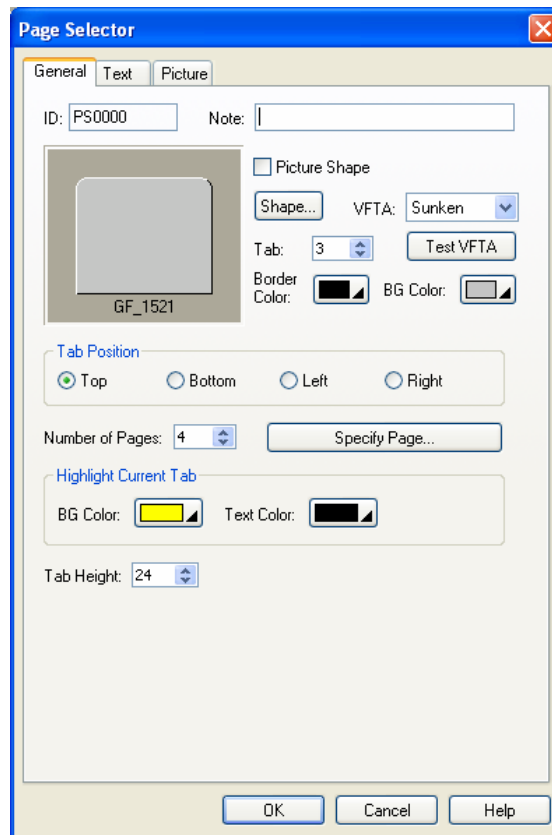

The following table describes each property in the General page.

Property	Description	
ID	The object's identifier. It is generated when the object is created. The identifier is unique within the screen where the object is located. The format of the IDs for the page selectors is PSnnnn.	
Note	You can type a note for this object.	
Shape settings	For details about the following properties, Section 4.3.4 Setting up the Shape of an Object . Picture Shape, Shape... , VFTA, Test VFTA , Border Color, BG Color	
Tab	Select a tab as the current tab so you can set the BG Color for that tab. You can also see how the tabs look when the selected tab is highlighted. Note: The current tab is always highlighted by the settings defined in the Highlight Current Tab group. Therefore, you cannot see the change of the BG color you made for the current tab immediately. To see the change, select another tab as the current tab.	
Tab Position	You can select Top/Bottom/Left/Right for the location of the tab.	
Number of Pages	Specifies the number of window screens this page selector contains.	
Specify Page...	Click this button to open the Specify Page dialog box. You can specify the window screen for each page in this dialog box.	
Highlight Current Tab	The settings for highlighting the text of the current tab.	
	BG Color	The color to replace the BG color of the current tab when highlighted.
	Text Color	The color to replace the text color of the current tab when highlighted.
Tab Height	The height of each tab.	

CHAPTER 6



LAMPS

6.1. Displaying Bit State Using Bit Lamps	1
6.1.1. Basic Operations	1
6.1.2. Operation Options.....	1
6.1.3. Settings	1
6.1.4. General Settings.....	2
6.2. Displaying Word State Using Multi-state Lamps	4
6.2.1. Basic Operations	4
6.2.2. Operation Options.....	4
6.2.3. Settings	5
6.2.4. General Settings.....	6
6.3. Displaying Text Information Using Message Displays	7
6.3.1. Basic Operations	7
6.3.2. Operation Options.....	7
6.3.3. Settings	8
6.3.4. General Settings.....	8

6.1. Displaying Bit State Using Bit Lamps

6.1.1. Basic Operations

You can use a bit to control the appearance of a bit lamp.

A bit lamp has two states, i.e. state 0 (Off) and state 1 (On). You can set the appearance of a bit lamp for each of the two states. At runtime, a bit lamp is displayed with the appearance settings corresponding to the state of the monitored bit.

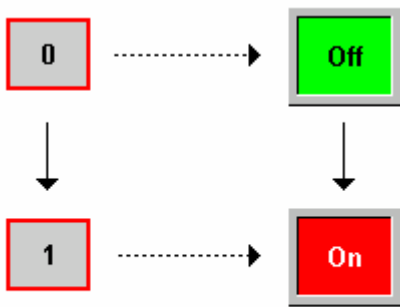

The monitored bit

The bit lamp

6.1.2. Operation Options

The following operation option can be added to a bit lamp. You need to select and set this option in the Bit Lamp property sheet.

Options	Description
Visibility Control	The object can be shown or hidden either by a specified bit or by the current user level. Select and set this option in the Visibility page.

6.1.3. Settings

You can complete all the settings of a bit lamp in the Bit Lamp property sheet. This sheet contains the following four pages. Some of the pages appear only when they are needed.

- **General**

Described in [Section 6.1.4.](#)

- **Label**

Described in [Section 4.3.5.](#)

- **Visibility**

Described in [Section 4.4.6.](#)

- **External Label**

Described in [Section 4.3.8.](#)

6.1.4. General Settings

This section describes how to define the general settings for a bit lamp.

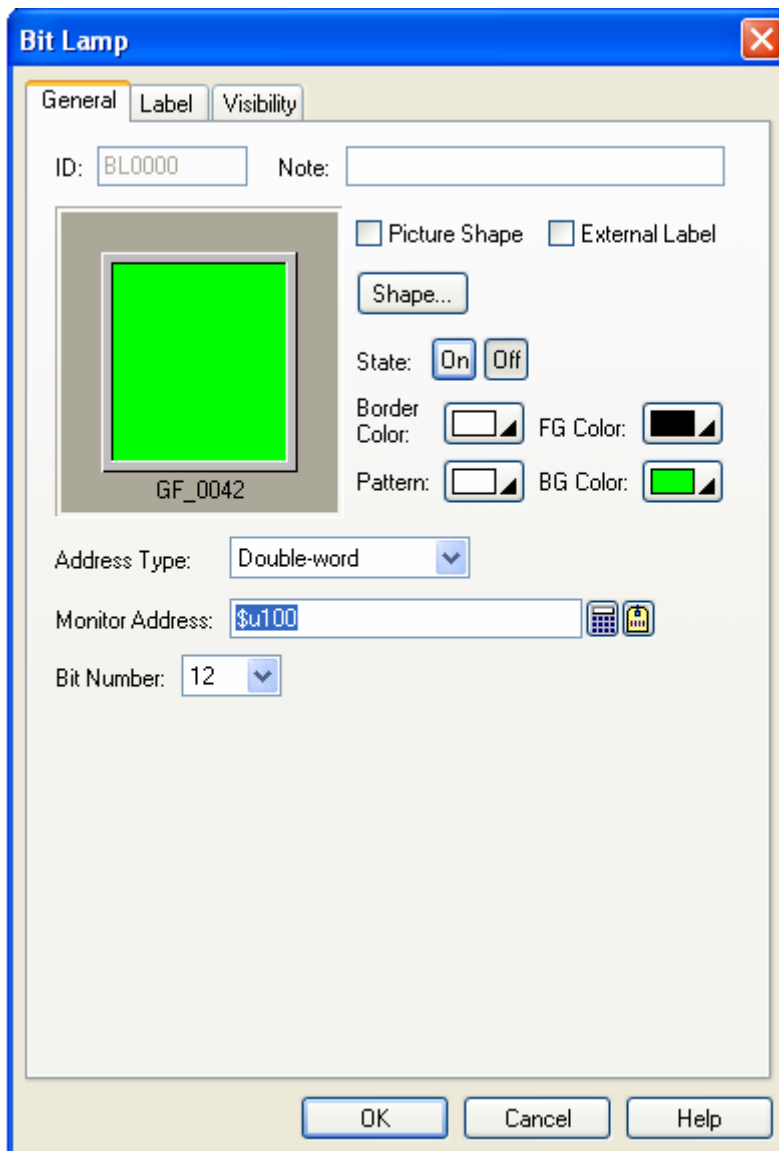





The above is an example of the General page of the Bit Lamp dialog box.

The following table describes each property in the General page.

Property	Description
ID	The object's identifier. It is generated when the object is created. The identifier is unique within the screen where the object is located. The format of the IDs for the bit lamps is BLnnnn.
Note	You can type a note for the object.
Shape settings	For details about the following properties, see Section 4.3.4 Setting up the Shape of an Object . Picture Shape, <input type="button" value="Shape..."/> , Border Color, Pattern, FG Color, BG Color
External Label	Check this option if you want the bit lamp to have an external label. Set up the external label in the External Label page.

Continued

Property		Description								
		Click this button to change the object state to 1 (On) so you can view and set the object appearance for state 1 (On).								
		Click this button to change the object state to 0 (Off) so you can view and set the object appearance for state 0 (Off).								
Monitor Address	Address Type	Specifies the type of variable in the Monitor Address field. The bit lamp supports the following three variable types:								
		<table border="1"> <thead> <tr> <th>Variable Type</th> <th>Description</th> </tr> </thead> <tbody> <tr> <td>Bit</td> <td>The variable is a bit variable.</td> </tr> <tr> <td>Word</td> <td>The variable is a word variable. You need to specify which bit in the word variable is to be monitored. Specify the bit number (0~15) in the Bit Number field.</td> </tr> <tr> <td>Double-word</td> <td>The variable is a double-word variable. You need to specify which bit in the double-word variable is to be monitored. Specify the bit number (0~31) in the Bit Number field.</td> </tr> </tbody> </table>	Variable Type	Description	Bit	The variable is a bit variable.	Word	The variable is a word variable. You need to specify which bit in the word variable is to be monitored. Specify the bit number (0~15) in the Bit Number field.	Double-word	The variable is a double-word variable. You need to specify which bit in the double-word variable is to be monitored. Specify the bit number (0~31) in the Bit Number field.
		Variable Type	Description							
		Bit	The variable is a bit variable.							
	Word	The variable is a word variable. You need to specify which bit in the word variable is to be monitored. Specify the bit number (0~15) in the Bit Number field.								
	Double-word	The variable is a double-word variable. You need to specify which bit in the double-word variable is to be monitored. Specify the bit number (0~31) in the Bit Number field.								
Monitor Address	Specifies the bit variable to be monitored when the Address Type is Bit. Specifies the word variable that contains the bit to be monitored when the Address Type is Word. Specifies the double-word variable that contains the bit to be monitored when the Address Type is Double-word.									
	Click this icon to bring up the Address Input Keypad and specify the desired address for the Monitor Address field.									
	Click this icon to bring up the Select Tag dialog box and select the desired tag for the Monitor Address field.									
Bit Number	Specifies which bit of the variable specified in the Monitor Address field is to be monitored.									

6.2. Displaying Word State Using Multi-state Lamps

6.2.1. Basic Operations

You can use a variable to control the appearance of a multi-state lamp.

A multi-state lamp can have up to 256 states. The maximum number of states that a multi-state lamp can have is determined by the state type and the data type of the monitored variable. The following table shows the maximum in each case.

		16-bit Variable	32-bit variable
State Type	Bit	2	2
	Value	256	256
	LSB	16	33

You need to specify the number of states for a multi-state lamp, and the number must not exceed the allowed maximum. You can set the appearance of a multi-state lamp for each of its states. At runtime, a multi-state lamp is displayed with the appearance settings corresponding to the state of the monitored variable. The state of the monitored variable is determined by the state type and value of the variable.

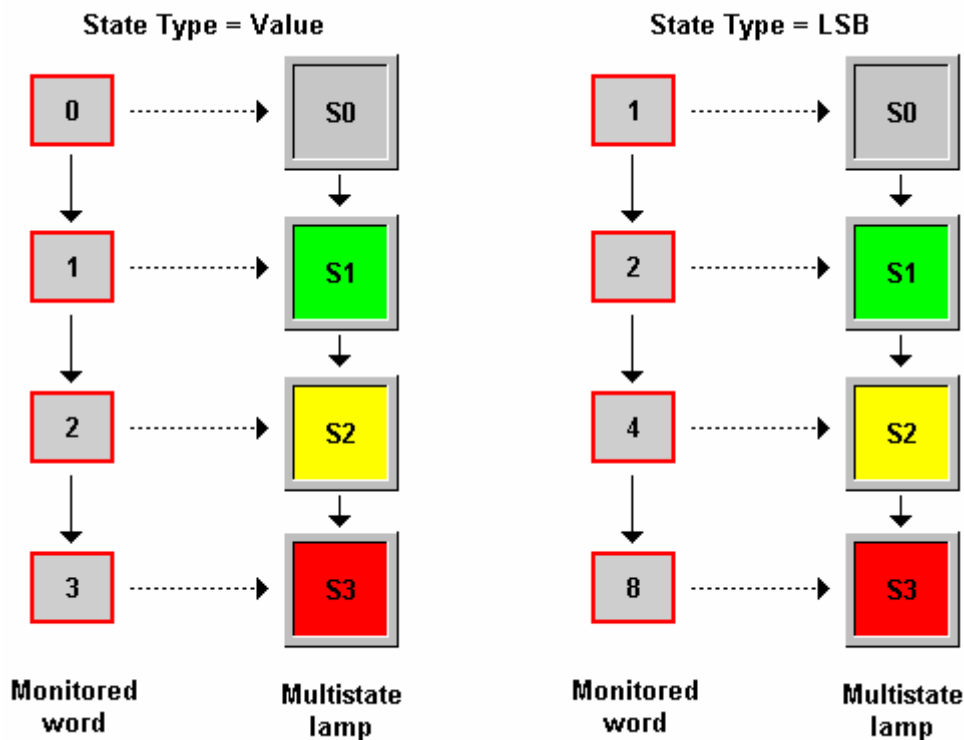

6.2.2. Operation Options

The following operation option can be added to a multi-state lamp. You need to select and set this option in the Multi-state Lamp property sheet.

Options	Description
Visibility Control	The object can be shown or hidden either by a specified bit or by the current user level. Select and set this option in the Visibility page.

6.2.3. Settings

You can complete all the settings of a multi-state lamp in the Multi-state Lamp property sheet. This dialog box contains the following five pages. Some of the pages appear only when they are needed.

- **General**

Described in [Section 6.2.4.](#)

- **Text**

Described in [Section 4.3.6.](#)

- **Picture**

Described in [Section 4.3.7.](#)

- **Visibility**

Described in [Section 4.4.6.](#)

- **External Label**



Described in [Section 4.3.8.](#)

6.2.4. General Settings

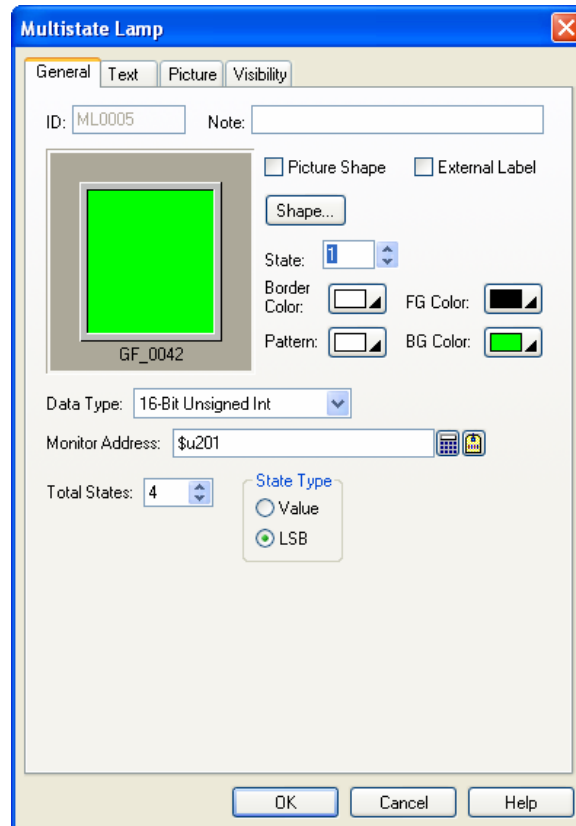
This section describes how to define the general settings for a multi-state lamp. The following is an example of the General page of the Multi-state Lamp property sheet.



The following table describes each property in the General page.

Property		Description
ID		The object's identifier. It is generated when the object is created. The identifier is unique within the screen where the object is located. The format of the IDs for the multi-state lamps is MLnnnn.
Note		You can type a note for the object.
Shape settings		For details about the following properties, see Section 4.3.4 Setting up the Shape of an Object , Picture Shape,  , Border Color, Pattern, FG Color, BG Color
External Label		Check this option if you want the multi-state lamp to have an external label. Set up the external label in the External Label page.
State		Select a state as the current state of the multi-state lamp so you can view and set the object appearance for that state.
Data Type		The data type of the monitored variable. The supported data types include: 16-bit Unsigned Integer, 16-bit BCD, 32-bit Unsigned Integer, and 32-bit BCD.
Monitor Address	Monitor Address	Specifies the variable to be monitored.
		Click this icon to bring up the Address Input Keypad and specify an address for the Monitor Address field.
		Click this icon to bring up the Select Tag dialog box and select a tag for the Monitor Address field.
Total States		Specifies the number of states that the multi-state lamp can display.
State Type		The state type for the state of the monitored variable. The supported state types include Value and LSB. For details, see Section 4.4.1.1 State Types

6.3. Displaying Text Information Using Message Displays

6.3.1. Basic Operations

You can use a variable to select and display a predefined message with a message display.

A message display can have up to 256 states. Each state can have a predefined message. The maximum number of states that a message display can have is determined by the state type and data type of the monitored variable. The following table shows the maximum in each case.

		Type of Variable	Maximum
State Type	Bit	Bit	2
	Value	16-bit	256
		32-bit	256
	LSB	16-bit	17
32-bit		33	

You need to specify the number of states for a message display, and the number must not exceed the allowed maximum. You can set the text (message) for each state. At runtime, a message display shows the message corresponding to the state of the monitored variable. The state of the monitored variable is determined by the state type and value of the variable.

Note: The differences between Message Display and Lamps are:

Lamps can display either text or picture, or both; while message display can only display text. Both message displays and lamps can display predefined text by changing the value of the monitored variable. However, only message displays can perform as a marquee that is controlled by the value of the monitored variable and a specified running speed.

6.3.2. Operation Options

The following operation option can be added to a message display. You need to select and set this option in the Message Display dialog box.

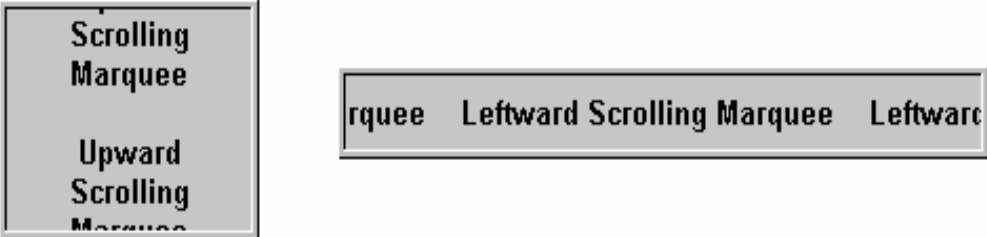
Options	Description
Marquee	<p>The displayed message scrolls automatically in the specified direction. When the displayed message is not long enough to cover the entire display area, the message is duplicated to fill the uncovered area in sequence.</p> 
Visibility Control	The object can be shown or hidden either by a specified bit or by the current user level. Select and set this option in the Visibility page.

6.3.3. Settings

You can complete all the settings of a message display in the Message Display dialog box. This dialog box contains the following four pages. Some of the pages appear only when they are needed.

- **General**

Described in [Section 6.3.4.](#)

- **Text**

Described in [Section 4.3.6.](#)

- **Visibility**

Described in [Section 4.4.6.](#)

- **External Label**



Described in [Section 4.3.8.](#)

6.3.4. General Settings

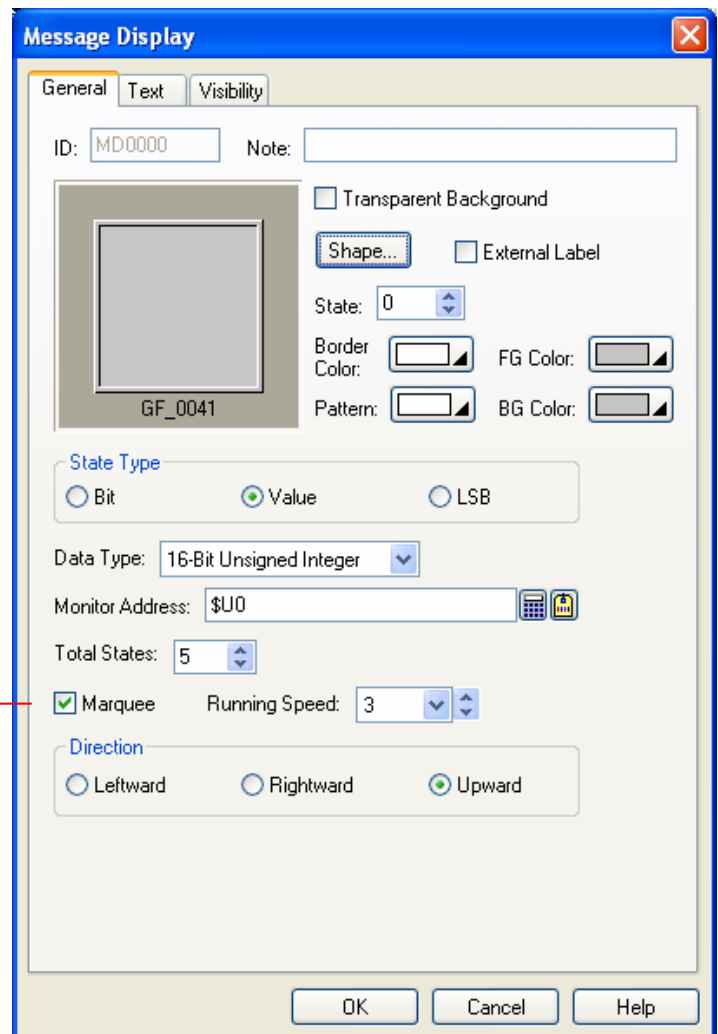
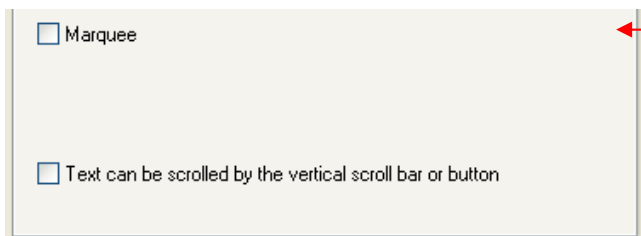
This section describes how to define the general settings for a message display. The following is an example of the General page of the Message Display property sheet.

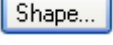

The following table describes each property in the General page.

Property		Description
ID		The object's identifier. It is generated when the object is created. The identifier is unique within the screen where the object is located. The format of the IDs for the message displays is MDnnnn.
Note		You can type a note for the object.
Shape settings		For details about the following properties, Section 4.3.4 Setting up the Shape of an Object .  , Border Color, Pattern, FG Color, BG Color
External Label		Check this option if you want the message display to have an external label. Set up the external label in the External Label page.
State		Select a state as the current state of the message display so you can view and set the Pattern, FG Color, BG Color for that state.
State Type		The state type of the variable that controls the message display. The supported state types include Bit, Value and LSB. For details, see Section 4.4.1.1 State Types
Data Type		The data type of the variable that controls the message display. The supported data types include: Bit, 16-bit Unsigned Integer, 16-bit BCD, 32-bit Unsigned Integer, and 32-bit BCD.
Monitor Address		Specifies the variable that controls the message display. Click  to enter an address for this field. Click  to select a tag for this field.
Total States		Specifies the number of states of the message display.
Marquee	Marquee	Select this item if you want the displayed message to scroll automatically.
	Running Speed	The speed of scrolling. Select from 1 to 10, 1 being the slowest and 10 being the fastest.
	Direction	The direction of scrolling. The supported directions include Leftward, Rightward, and Upward.
Text can be scrolled by the vertical scroll bar or button		Select this option so you can scroll the content of the message display vertically using the associated scroll buttons or scroll bar.

CHAPTER 7

DISPLAYING AND INPUTTING DATA

7.1. Numeric Entries.....	1
7.1.1. Operation Options.....	1
7.1.2. Settings	2
7.1.3. General Settings.....	2
7.1.4. Advanced Settings for Numeric Entries	5
7.2. Numeric Displays.....	8
7.2.1. Operation Options.....	8
7.2.2. Settings	8
7.2.3. General Settings.....	9
7.2.4. Advanced Settings	11
7.3. Advanced Numeric Displays.....	12
7.3.1. Advanced Features.....	12
7.3.2. Operation Options.....	12
7.3.3. Settings	13
7.3.4. General Settings.....	13
7.3.5. Range Settings	16
7.4. Character Entries	18
7.4.1. Operation Options.....	18
7.4.2. Settings	18
7.4.3. General Settings.....	19
7.4.4. Advanced Settings	21
7.5. Character Displays	23
7.5.1. Operation Options.....	23
7.5.2. Settings	23
7.5.3. General Settings.....	24
7.6. Time Displays.....	25
7.6.1. Settings	25
7.7. Date Displays.....	26
7.7.1. Settings	26
7.8. Day-of-week Displays	27
7.8.1. Settings	27
7.8.2. General Settings.....	27

7.1. Numeric Entries

You can enter a value and change the specified variable using a numeric entry.

7.1.1. Operation Options

The following operation options can be added to a numeric entry. Select and set up the options in the Numeric Entry property sheet.

Options	Description
Scaling	<p>The value of the monitored variable will be displayed in a scaled manner. The following is the scaling formula.</p> $\text{DisplayedValue} = \text{MonitoredValue} * \text{Gain} + \text{Offset}$ <p>If the option is selected, the entered value will be scaled by the following formula with the same coefficients (<i>Gain</i> and <i>Offset</i>) before it is output.</p> $\text{OutputValue} = (\text{EnteredValue} - \text{Offset}) / \text{Gain}$ <p>Select and set this option in the Advanced page.</p> <p>Note: The <i>Gain</i> and <i>Offset</i> are 32-bit floating point numbers. They have, at most, 6 significant digits. Rounding and truncation errors may occur.</p>
Range Check	<p>Numeric entry will verify an entered value according to the specified maximum and minimum. If the entered value is not within the allowable range, the value will not be output. Select and set this option in the Advanced page.</p> <p>Note 1: When the scaling option is selected, the output value is verified instead of the entered value.</p> $\text{OutputValue} = (\text{EnteredValue} - \text{Offset}) / \text{Gain}$ <p>Note 2: When the scaling option is selected, the allowable maximum and minimum shown on the numeric keypad are the scaled versions of the specified maximum and minimum.</p> $\text{ScaledMaximum} = \text{Maximum} * \text{Gain} + \text{Offset}$ $\text{ScaledMinimum} = \text{Minimum} * \text{Gain} + \text{Offset}$
Touch Operation Control	You can enable or disable the touch operation of the object by the specified bit or by the current user level. Select and set up this option in the Advanced page.
Timeout	If the keypad for data entry receives no input for the specified time period, the data entry operation will be cancelled.
Notification	The Object will notify the specified bit of a successful data entry operation. Select and set up this option in the Advanced page.
Operator Confirmation	When a value is entered by the operator, the Confirmation box will be displayed to receive the operator's confirmation. If the operator selects "Yes", the object will write the entered data to the specified variable. If the operator selects "No" or the operator does not respond within the specified time period (Maximum Waiting Time), the data entry operation will be cancelled. Select and set up this option in the Advanced page.
Operation Logging	The entered value and the time of the data entry will be recorded. Select and set up this option in the Advanced page.
Visibility Control	You can show or hide the object by the specified bit or by the current user level. Select and set up this option in the Visibility page.

7.1.2. Settings

You can complete all the settings of a numeric entry in the Numeric Entry property sheet. This sheet contains the following four pages. Some of the pages appear only when they are needed.



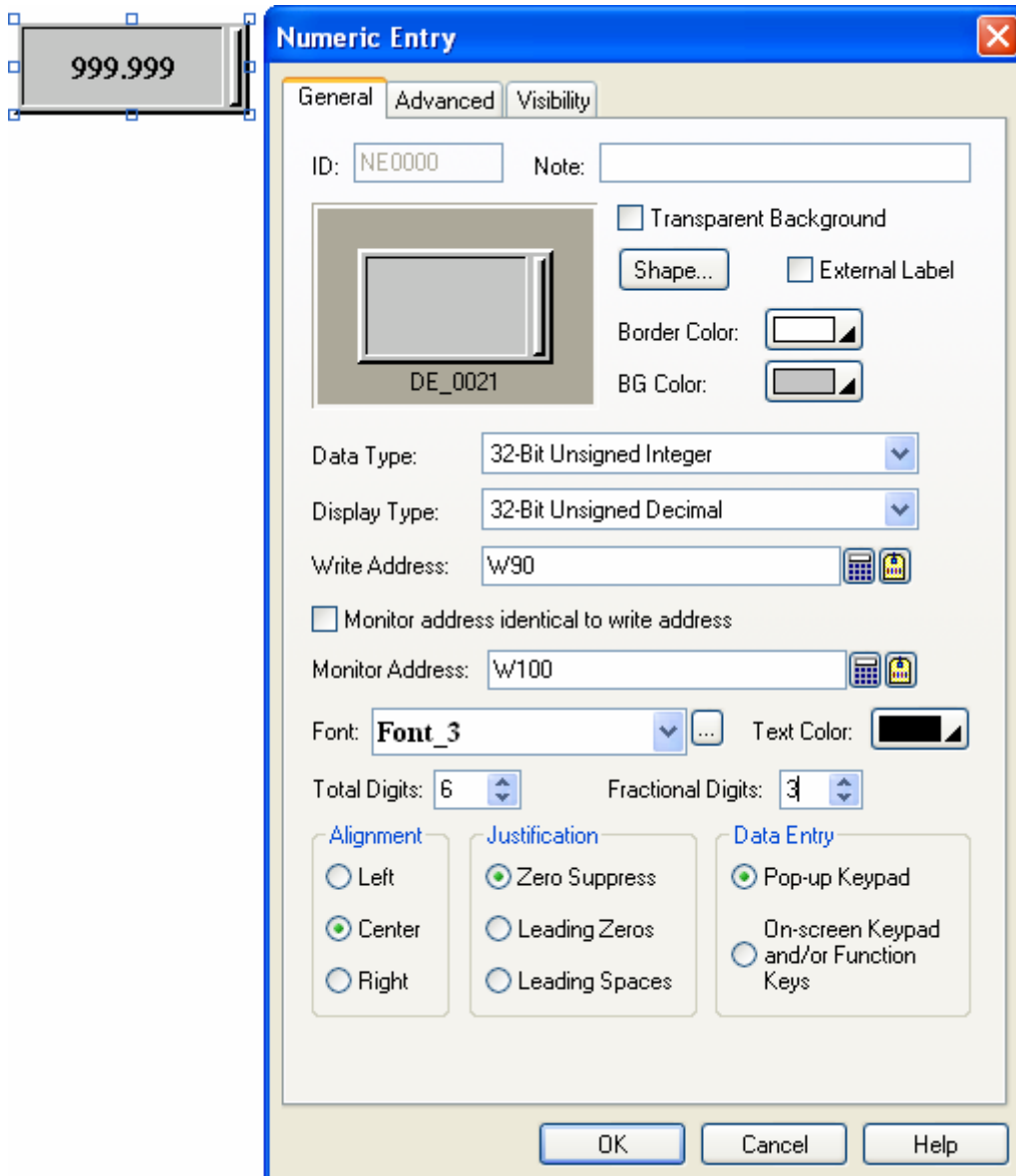

- **General**
Described in [Section 7.1.3.](#)
- **Advanced**
Described in [Section 7.1.4.](#)
- **Visibility**
Described in [Section 4.4.6.](#)
- **External Label**
Described in [Section 4.3.8.](#)

7.1.3. General Settings

This section describes how to define the general settings for a numeric entry. The following is an example of the General page of the Numeric Entry property sheet.



The following table describes each property in the General page.

Property	Description																								
ID	The object's identifier. It is generated when the object is created. The identifier is unique within the screen where the object is located. The format of the IDs for the numeric entries is NEEnnn.																								
Note	You can type a note for the object.																								
Transparent Background	Select this option if you want the object to have a transparent background.																								
Shape settings	For details about the following properties, see Section 4.3.4 Setting up the Shape of an Object .  , Border Color, BG Color.																								
External Label	Check this option if you want the object to have an external label. Set up the external label in the External Label page.																								
Data Type	The data type of the destination variable and the monitored variable. The supported data types include: 16-Bit Unsigned Integer, 32-Bit Unsigned Integer, 16-Bit Signed Integer, 32-Bit Signed Integer, 16-Bit BCD, 32-Bit BCD, 32-Bit Floating Point, 16-Bit Signed BCD (LMB), 32-Bit Signed BCD (LMB), 16-Bit Signed BCD (LMD), and 32-Bit Signed BCD (LMD).																								
Display Type	The display type of the value of the monitored variable. The following table shows the available display types for each data type. <table border="1" data-bbox="300 860 1501 1397"> <thead> <tr> <th>Data Type</th> <th>Available Display Types</th> </tr> </thead> <tbody> <tr> <td>16-Bit Unsigned Integer</td> <td>16-Bit Unsigned Decimal, 16-Bit Hexadecimal, 16-Bit Octal</td> </tr> <tr> <td>32-Bit Unsigned Integer</td> <td>32-Bit Unsigned Decimal, 32-Bit Hexadecimal, 32-Bit Octal, Password</td> </tr> <tr> <td>16-Bit Signed Integer</td> <td>16-Bit Signed Decimal</td> </tr> <tr> <td>32-Bit Signed Integer</td> <td>32-Bit Signed Decimal</td> </tr> <tr> <td>16-Bit BCD</td> <td>16-Bit Unsigned Decimal</td> </tr> <tr> <td>32-Bit BCD</td> <td>32-Bit Unsigned Decimal</td> </tr> <tr> <td>32-Bit Floating Point</td> <td>32-Bit Floating Point</td> </tr> <tr> <td>16-Bit Signed BCD (LMB)</td> <td>16-Bit Signed Decimal</td> </tr> <tr> <td>32-Bit Signed BCD (LMB)</td> <td>32-Bit Signed Decimal</td> </tr> <tr> <td>16-Bit Signed BCD (LMD)</td> <td>16-Bit Signed Decimal</td> </tr> <tr> <td>32-Bit Signed BCD (LMD)</td> <td>32-Bit Signed Decimal</td> </tr> </tbody> </table>	Data Type	Available Display Types	16-Bit Unsigned Integer	16-Bit Unsigned Decimal, 16-Bit Hexadecimal, 16-Bit Octal	32-Bit Unsigned Integer	32-Bit Unsigned Decimal, 32-Bit Hexadecimal, 32-Bit Octal, Password	16-Bit Signed Integer	16-Bit Signed Decimal	32-Bit Signed Integer	32-Bit Signed Decimal	16-Bit BCD	16-Bit Unsigned Decimal	32-Bit BCD	32-Bit Unsigned Decimal	32-Bit Floating Point	32-Bit Floating Point	16-Bit Signed BCD (LMB)	16-Bit Signed Decimal	32-Bit Signed BCD (LMB)	32-Bit Signed Decimal	16-Bit Signed BCD (LMD)	16-Bit Signed Decimal	32-Bit Signed BCD (LMD)	32-Bit Signed Decimal
Data Type	Available Display Types																								
16-Bit Unsigned Integer	16-Bit Unsigned Decimal, 16-Bit Hexadecimal, 16-Bit Octal																								
32-Bit Unsigned Integer	32-Bit Unsigned Decimal, 32-Bit Hexadecimal, 32-Bit Octal, Password																								
16-Bit Signed Integer	16-Bit Signed Decimal																								
32-Bit Signed Integer	32-Bit Signed Decimal																								
16-Bit BCD	16-Bit Unsigned Decimal																								
32-Bit BCD	32-Bit Unsigned Decimal																								
32-Bit Floating Point	32-Bit Floating Point																								
16-Bit Signed BCD (LMB)	16-Bit Signed Decimal																								
32-Bit Signed BCD (LMB)	32-Bit Signed Decimal																								
16-Bit Signed BCD (LMD)	16-Bit Signed Decimal																								
32-Bit Signed BCD (LMD)	32-Bit Signed Decimal																								
Write Address	Specifies the destination variable where the entered value will be written. Click  to enter an address for this field. Click  to select a tag for this field.																								
Monitor Address identical to Write Address	Specifies that the monitored variable is the same as the destination variable. With this item checked, you don't need to specify the monitored variable in the Monitor Address field.																								
Monitor Address	Specifies the monitored variable. Click  to enter an address for this field. Click  to select a tag for this field.																								
Font	The font of the displayed value.																								
Text Color	The color of the displayed value.																								
Total Digits	The number of digits to be displayed. Note: This property applies to the display of the initial value, the allowable minimum, and the allowable maximum on the numeric keypad.																								

Continued







Property	Description																																																												
Fractional Digits	<p>When the Display Type is 32-bit Floating Point, this property specifies the number of fractional digits displayed.</p> <p>When the Display Type is not 32-bit Floating Point, this property specifies not only the number of fractional digits displayed, but also the number of least significant digits displayed as the fractional part. With this feature, an integer can be shown and entered as a fixed point number. When the Fractional Digits is nonzero, say N, the entered value will be converted to an integer according to the following formula before being output.</p> <p>OutputValue = EnteredValue * (Nth power of 10)</p> <p>Example 1:</p> <table border="1"> <thead> <tr> <th>Display Type</th> <th>Total Digits</th> <th>Fractional Digits</th> <th>Justification</th> <th>Monitored Value</th> <th>Displayed Value</th> </tr> </thead> <tbody> <tr> <td>32-bit Floating Point</td> <td>4</td> <td>2</td> <td>Zero Suppress</td> <td>12.34</td> <td>12.34</td> </tr> <tr> <td>32-bit Floating Point</td> <td>4</td> <td>2</td> <td>Zero Suppress</td> <td>123.4</td> <td>23.40</td> </tr> <tr> <td>16-bit Signed Decimal</td> <td>5</td> <td>2</td> <td>Zero Suppress</td> <td>12345</td> <td>123.45</td> </tr> <tr> <td>16-bit Signed Decimal</td> <td>5</td> <td>2</td> <td>Zero Suppress</td> <td>-5</td> <td>-0.05</td> </tr> </tbody> </table> <p>Example 2:</p> <table border="1"> <thead> <tr> <th>Display Type</th> <th>Total Digits</th> <th>Fractional Digits</th> <th>Entered Value</th> <th>Output Value</th> </tr> </thead> <tbody> <tr> <td>32-bit Floating Point</td> <td>4</td> <td>2</td> <td>12.34</td> <td>12.34</td> </tr> <tr> <td>32-bit Floating Point</td> <td>4</td> <td>2</td> <td>123.4</td> <td>Error!</td> </tr> <tr> <td>16-bit Signed Decimal</td> <td>5</td> <td>2</td> <td>123.45</td> <td>12345</td> </tr> <tr> <td>16-bit Signed Decimal</td> <td>5</td> <td>2</td> <td>-0.05</td> <td>-5</td> </tr> <tr> <td>16-bit Signed Decimal</td> <td>5</td> <td>2</td> <td>3</td> <td>300</td> </tr> </tbody> </table> <p>Note: This property applies to the display of the initial value, the allowable minimum, and the allowable maximum on the numeric keypad.</p>	Display Type	Total Digits	Fractional Digits	Justification	Monitored Value	Displayed Value	32-bit Floating Point	4	2	Zero Suppress	12.34	12.34	32-bit Floating Point	4	2	Zero Suppress	123.4	23.40	16-bit Signed Decimal	5	2	Zero Suppress	12345	123.45	16-bit Signed Decimal	5	2	Zero Suppress	-5	-0.05	Display Type	Total Digits	Fractional Digits	Entered Value	Output Value	32-bit Floating Point	4	2	12.34	12.34	32-bit Floating Point	4	2	123.4	Error!	16-bit Signed Decimal	5	2	123.45	12345	16-bit Signed Decimal	5	2	-0.05	-5	16-bit Signed Decimal	5	2	3	300
Display Type	Total Digits	Fractional Digits	Justification	Monitored Value	Displayed Value																																																								
32-bit Floating Point	4	2	Zero Suppress	12.34	12.34																																																								
32-bit Floating Point	4	2	Zero Suppress	123.4	23.40																																																								
16-bit Signed Decimal	5	2	Zero Suppress	12345	123.45																																																								
16-bit Signed Decimal	5	2	Zero Suppress	-5	-0.05																																																								
Display Type	Total Digits	Fractional Digits	Entered Value	Output Value																																																									
32-bit Floating Point	4	2	12.34	12.34																																																									
32-bit Floating Point	4	2	123.4	Error!																																																									
16-bit Signed Decimal	5	2	123.45	12345																																																									
16-bit Signed Decimal	5	2	-0.05	-5																																																									
16-bit Signed Decimal	5	2	3	300																																																									
Alignment	The alignment of the displayed value. There are three types of alignment: Left, Center, and Right.																																																												
Justification	<p>The justification of the displayed value. There are three types of justification:</p> <table border="1"> <thead> <tr> <th>Option</th> <th>Description</th> </tr> </thead> <tbody> <tr> <td>Zero Suppress</td> <td>The leading digits will not be displayed when they are 0.</td> </tr> <tr> <td>Leading Zeros</td> <td>All digits will be displayed.</td> </tr> <tr> <td>Leading Spaces</td> <td>The leading digits will be displayed as a blank character when they are 0.</td> </tr> </tbody> </table>	Option	Description	Zero Suppress	The leading digits will not be displayed when they are 0.	Leading Zeros	All digits will be displayed.	Leading Spaces	The leading digits will be displayed as a blank character when they are 0.																																																				
Option	Description																																																												
Zero Suppress	The leading digits will not be displayed when they are 0.																																																												
Leading Zeros	All digits will be displayed.																																																												
Leading Spaces	The leading digits will be displayed as a blank character when they are 0.																																																												
Data Entry	<p>Specifies how to enter a value for the numeric entry at runtime. There are two options:</p> <table border="1"> <thead> <tr> <th>Option</th> <th>Description</th> </tr> </thead> <tbody> <tr> <td>Pop-up Keypad</td> <td>You can bring up the keypad by pressing numeric entry and then enter a value with the keypad.</td> </tr> <tr> <td>On-screen Keypad and/or Function Keys</td> <td>You can move the cursor by using the function buttons with the operation of "Select Next Data Entry Object" or "Select Previous Data Entry Object" to select numeric entry. If there is an on-screen keypad, you can enter a value for the numeric entry immediately. You can also use the function buttons with the operation of "Increase Value By One" or "Decrease Value By One" to change the value of the destination variable.</td> </tr> </tbody> </table> <p>Note: When On-screen Keypad and/or Function Keys option is selected, you can only enter a value for the numeric entry with the input focus. To set the input focus on the corresponding object, you need to click the object first.</p>	Option	Description	Pop-up Keypad	You can bring up the keypad by pressing numeric entry and then enter a value with the keypad.	On-screen Keypad and/or Function Keys	You can move the cursor by using the function buttons with the operation of "Select Next Data Entry Object" or "Select Previous Data Entry Object" to select numeric entry. If there is an on-screen keypad, you can enter a value for the numeric entry immediately. You can also use the function buttons with the operation of "Increase Value By One" or "Decrease Value By One" to change the value of the destination variable.																																																						
Option	Description																																																												
Pop-up Keypad	You can bring up the keypad by pressing numeric entry and then enter a value with the keypad.																																																												
On-screen Keypad and/or Function Keys	You can move the cursor by using the function buttons with the operation of "Select Next Data Entry Object" or "Select Previous Data Entry Object" to select numeric entry. If there is an on-screen keypad, you can enter a value for the numeric entry immediately. You can also use the function buttons with the operation of "Increase Value By One" or "Decrease Value By One" to change the value of the destination variable.																																																												

7.1.4. Advanced Settings for Numeric Entries

This section describes how to define the advanced settings for numeric entries. The following is an example of the Advanced page of the Numeric Entry property sheet.

The following table describes each property in the Advanced page.

Property		Description
Scaling	Scaling	Check this option if you want the value of the monitored variable to be displayed in a scaled manner. The following is the scaling formula. $\text{DisplayedValue} = \text{MonitoredValue} * \text{Gain} + \text{Offset}$ If this option is selected, the entered value will be scaled by the following formula with the same coefficients (<i>Gain</i> and <i>Offset</i>) before it is output. $\text{OutputValue} = (\text{EnteredValue} - \text{Offset}) / \text{Gain}$ Note: The <i>Gain</i> and <i>Offset</i> are 32-bit floating point numbers. They have, at most, 6 significant digits. Rounding and truncation errors may occur.
	Gain	The <i>Gain</i> of the scaling formulas.
	Offset	The <i>Offset</i> of the scaling formulas.

Property		Description						
Range Check	Range Check	<p>Check this option if you want numeric entry to verify an entered value according to the specified minimum and maximum. If the entered value is not within the allowable range, the entered value will not be output.</p> <p>Note 1: When the scaling option is selected, the output value is verified instead of the entered value.</p> $\text{OutputValue} = (\text{EnteredValue} - \text{Offset}) / \text{Gain}$ <p>Note 2: When the scaling option is selected, the allowable maximum and minimum shown on the keypad are the scaled versions of the specified maximum and minimum.</p> $\text{ScaledMaximum} = \text{Maximum} * \text{Gain} + \text{Offset}$ $\text{ScaledMinimum} = \text{Minimum} * \text{Gain} + \text{Offset}$						
	Variable Range	Check this option if the minimum and maximum are specified by the designated variables at runtime.						
	Min.	<p>Specifies the minimum when the Variable Range is not selected.</p> <p>When the Variable Range is selected, this property specifies the variable that stores the minimum at runtime. Click  to enter an address. Click  to select a tag.</p>						
	Max.	<p>Specifies the maximum when the Variable Range is not selected.</p> <p>When the Variable Range is selected, this property specifies the variable that stores the maximum at runtime. Click  to enter an address. Click  to select a tag.</p>						
Touch Operation Control	Enabled by Bit	Check this option so the touch operation of numeric entry will be enabled and disabled by the specified bit.						
	Control Bit	<p>Specifies the bit that enables and disables the touch operation.</p> <p>Click  to enter a bit address. Click  to select a bit tag.</p>						
	Enabling State	Specifies the state (On or Off) that enables the touch operation.						
	Enabled by User Level	Check this item so the touch operation of numeric entry will be enabled and disabled by the current user level.						
	Lowest Enabling User Level	Specifies the lowest user level that is required to enable the touch operation.						
	Show Disabled Sign	Check this option so the touch operation disabled sign will be shown on numeric entry when the touch operation is disabled.						
Timeout	Timeout	Check this option so data entry will be cancelled if the numeric keypad does not receive any input within the specified time.						
	Timeout Time	Specifies the maximum time that the numeric keypad will wait to receive a new input. If there is no input within the specified time, the numeric keypad will be closed and data entry will be cancelled.						
Notification	Notification	Check this option so numeric entry will notify the specified bit after it finishes outputting the entered value to the destination variable.						
	Signal	<p>Select one of the following signals for the notification:</p> <table border="1"> <thead> <tr> <th>Signal</th> <th>Description</th> </tr> </thead> <tbody> <tr> <td>Level</td> <td>Set a specified bit to the specified state.</td> </tr> <tr> <td>Pulse</td> <td>Send a positive pulse to the specified bit.</td> </tr> </tbody> </table>	Signal	Description	Level	Set a specified bit to the specified state.	Pulse	Send a positive pulse to the specified bit.
	Signal	Description						
	Level	Set a specified bit to the specified state.						
	Pulse	Send a positive pulse to the specified bit.						
Bit	Specifies the bit that receives the notification.							
State	Specifies the state (On or Off) that is used for the notification.							

Continued

Property		Description
Operator Confirmation	Operator Confirmation	Check this option if you want the operator to confirm what he/she enters for the numeric entry. The Confirmation box will be displayed when a value is entered for numeric entry. If the operator selects "Yes" in the Confirmation box, numeric entry will write the entered value to the specified variable. If the operator selects "No" or the operator does not respond within the specified time period (Maximum Waiting Time), numeric entry will cancel the data entry operation.
	Maximum Waiting Time	Specifies the maximum time that numeric entry will wait for the operator's confirmation. Data entry will be cancelled if the operator does not respond within this time.
Operation Logging	Operation Logging	Check this option so the following three items will be recorded in the operation log when numeric entry outputs the entered value. There are three recorded items: 1) The time when the operation is performed 2) The entered value 3) The predefined operation message
	Message	Enter the operation message of the first language.
		Click this button to bring up the Operation Message dialog box so that you can edit the operation message for all the languages.

7.2. Numeric Displays

You can use a numeric display to show the value of the specified variable.

7.2.1. Operation Options

The following operation options can be added to a numeric display. Select and set up the options in the Numeric Display property sheet.

Options	Description
Scaling	The value of the monitored variable will be scaled by the following formula before it is displayed. $\text{DisplayedValue} = \text{MonitoredValue} * \text{Gain} + \text{Offset}$ Select and set this option in the Advanced page. Note: The <i>Gain</i> and <i>Offset</i> are 32-bit floating point numbers. They have, at most, 6 significant digits. Rounding and truncation errors may occur.
Range Display	You can specify a low limit and a high limit for the numeric display. The limits can be constants or variables. At runtime, when the value of the monitored variable is below the low limit, the numeric display will show the value with the text color and the BG color set for the low limit. When the value of the monitored variable is above the high limit, the numeric display will show the value with the text color and the BG color set for the high limit.
Visibility Control	You can show and hide the numeric display by the specified bit or the current user level. Select and set this option in the Visibility page.

7.2.2. Settings

You can complete all the settings of a numeric display in the Numeric Display property sheet. This sheet contains the following four pages. Some of the pages appear only when they are needed.

- **General**
Described in [Section 7.2.3.](#)
- **Advanced**
Described in [Section 7.2.4.](#)
- **Visibility**
Described in [Section 4.4.6.](#)
- **External Label**
Described in [Section 4.3.8.](#)

7.2.3. General Settings

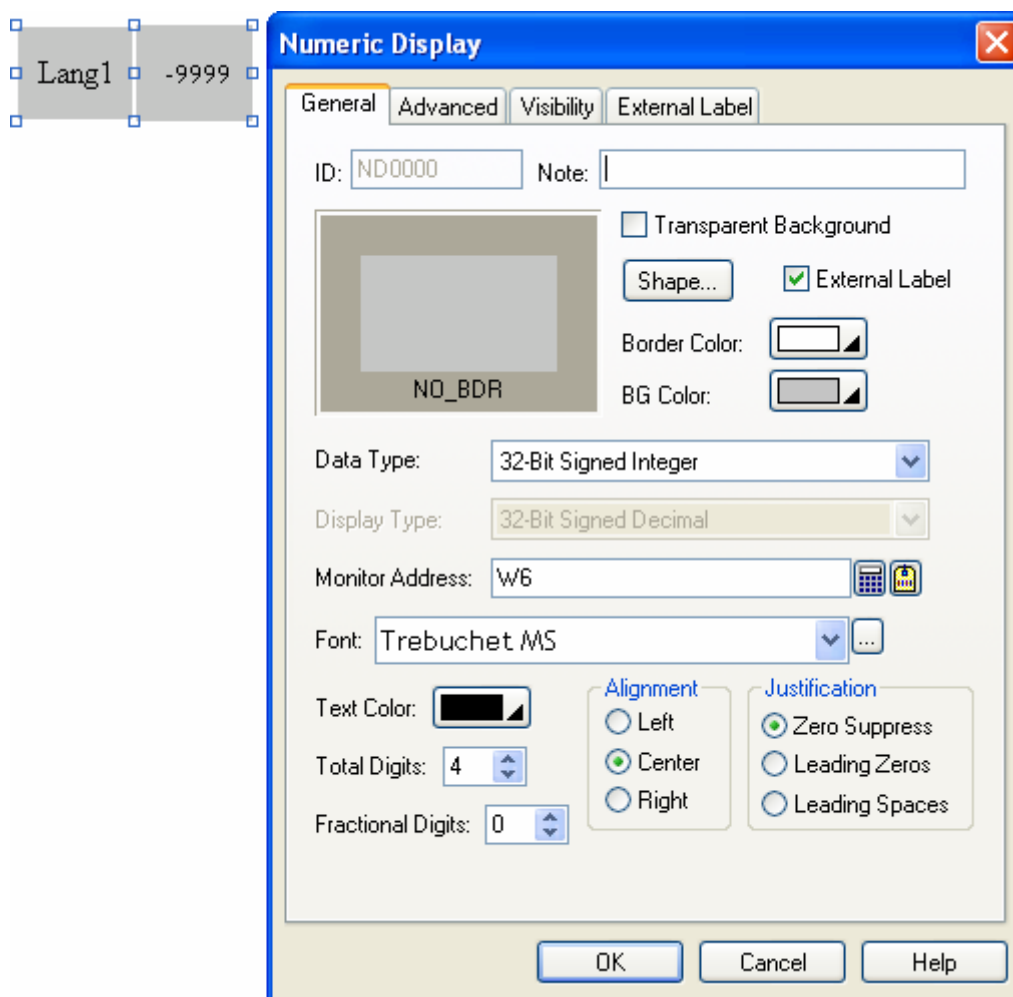

This section describes how to define the general settings for a numeric display. The following is an example of the General page of the Numeric Display property sheet.



The following table describes each property in the General page.

Property	Description
ID	The object's identifier. It is generated when the object is created. The identifier is unique within the screen where the object is located. The format of the IDs for the numeric displays is NDnnnn.
Note	You can type a note for the object.
Transparent Background	Select this option if you want the object to have a transparent background.
Shape settings	For details about the following properties, see Section 4.3.4 Setting up the Shape of an Object. Shape... , Border Color, BG Color
External Label	Check this option if you want the object to have an external label. Set up the external label in the External Label page.
Data Type	The data type of the monitored variable. The supported data types include: 16-Bit Unsigned Integer, 32-Bit Unsigned Integer, 16-Bit Signed Integer, 32-Bit Signed Integer, 16-Bit BCD, 32-Bit BCD, 32-Bit Floating Point, 16-Bit Signed BCD (LMB), 32-Bit Signed BCD (LMB), 16-Bit Signed BCD (LMD), and 32-Bit Signed BCD (LMD).

Continued

Property	Description																														
Display Type	<p>The display type of the value of the monitored variable. The following table shows the available display types for each data type.</p> <table border="1"> <thead> <tr> <th>Data Type</th> <th>Available Display Types</th> </tr> </thead> <tbody> <tr> <td>16-Bit Unsigned Integer</td> <td>16-Bit Unsigned Decimal, 16-Bit Hexadecimal, 16-Bit Octal</td> </tr> <tr> <td>32-Bit Unsigned Integer</td> <td>32-Bit Unsigned Decimal, 32-Bit Hexadecimal, 32-Bit Octal</td> </tr> <tr> <td>16-Bit Signed Integer</td> <td>16-Bit Signed Decimal</td> </tr> <tr> <td>32-Bit Signed Integer</td> <td>32-Bit Signed Decimal</td> </tr> <tr> <td>16-Bit BCD</td> <td>16-Bit Unsigned Decimal</td> </tr> <tr> <td>32-Bit BCD</td> <td>32-Bit Unsigned Decimal</td> </tr> <tr> <td>32-Bit Floating Point</td> <td>32-Bit Floating Point</td> </tr> <tr> <td>16-Bit Signed BCD (LMB)</td> <td>16-Bit Signed Decimal</td> </tr> <tr> <td>32-Bit Signed BCD (LMB)</td> <td>32-Bit Signed Decimal</td> </tr> <tr> <td>16-Bit Signed BCD (LMD)</td> <td>16-Bit Signed Decimal</td> </tr> <tr> <td>32-Bit Signed BCD (LMD)</td> <td>32-Bit Signed Decimal</td> </tr> </tbody> </table>	Data Type	Available Display Types	16-Bit Unsigned Integer	16-Bit Unsigned Decimal, 16-Bit Hexadecimal, 16-Bit Octal	32-Bit Unsigned Integer	32-Bit Unsigned Decimal, 32-Bit Hexadecimal, 32-Bit Octal	16-Bit Signed Integer	16-Bit Signed Decimal	32-Bit Signed Integer	32-Bit Signed Decimal	16-Bit BCD	16-Bit Unsigned Decimal	32-Bit BCD	32-Bit Unsigned Decimal	32-Bit Floating Point	32-Bit Floating Point	16-Bit Signed BCD (LMB)	16-Bit Signed Decimal	32-Bit Signed BCD (LMB)	32-Bit Signed Decimal	16-Bit Signed BCD (LMD)	16-Bit Signed Decimal	32-Bit Signed BCD (LMD)	32-Bit Signed Decimal						
Data Type	Available Display Types																														
16-Bit Unsigned Integer	16-Bit Unsigned Decimal, 16-Bit Hexadecimal, 16-Bit Octal																														
32-Bit Unsigned Integer	32-Bit Unsigned Decimal, 32-Bit Hexadecimal, 32-Bit Octal																														
16-Bit Signed Integer	16-Bit Signed Decimal																														
32-Bit Signed Integer	32-Bit Signed Decimal																														
16-Bit BCD	16-Bit Unsigned Decimal																														
32-Bit BCD	32-Bit Unsigned Decimal																														
32-Bit Floating Point	32-Bit Floating Point																														
16-Bit Signed BCD (LMB)	16-Bit Signed Decimal																														
32-Bit Signed BCD (LMB)	32-Bit Signed Decimal																														
16-Bit Signed BCD (LMD)	16-Bit Signed Decimal																														
32-Bit Signed BCD (LMD)	32-Bit Signed Decimal																														
Monitor Address	<p>Specifies the monitored variable.</p> <p>Click  to enter an address for this field. Click  to select a tag for this field.</p>																														
Font	The font of the displayed value.																														
Text Color	The color of the displayed value.																														
Total Digits	The number of digits to be displayed.																														
Fractional Digits	<p>When the Display Type is 32-bit Floating Point, this property specifies the number of fractional digits to be displayed.</p> <p>When the Display Type is not 32-bit Floating Point, this property specifies not only the number of fractional digits to be displayed, but also the number of least significant digits to be displayed as the fractional part. With this feature, an integer can be shown as a fixed point number.</p> <p>Example:</p> <table border="1"> <thead> <tr> <th>Display Type</th> <th>Total Digits</th> <th>Fractional Digits</th> <th>Justification</th> <th>Monitored Value</th> <th>Displayed Value</th> </tr> </thead> <tbody> <tr> <td>32-bit Floating Point</td> <td>4</td> <td>2</td> <td>Zero Suppress</td> <td>12.34</td> <td>12.34</td> </tr> <tr> <td>32-bit Floating Point</td> <td>4</td> <td>2</td> <td>Zero Suppress</td> <td>123.4</td> <td>23.40</td> </tr> <tr> <td>16-bit Signed Decimal</td> <td>5</td> <td>2</td> <td>Zero Suppress</td> <td>12345</td> <td>123.45</td> </tr> <tr> <td>16-bit Signed Decimal</td> <td>5</td> <td>2</td> <td>Zero Suppress</td> <td>-5</td> <td>-0.05</td> </tr> </tbody> </table>	Display Type	Total Digits	Fractional Digits	Justification	Monitored Value	Displayed Value	32-bit Floating Point	4	2	Zero Suppress	12.34	12.34	32-bit Floating Point	4	2	Zero Suppress	123.4	23.40	16-bit Signed Decimal	5	2	Zero Suppress	12345	123.45	16-bit Signed Decimal	5	2	Zero Suppress	-5	-0.05
Display Type	Total Digits	Fractional Digits	Justification	Monitored Value	Displayed Value																										
32-bit Floating Point	4	2	Zero Suppress	12.34	12.34																										
32-bit Floating Point	4	2	Zero Suppress	123.4	23.40																										
16-bit Signed Decimal	5	2	Zero Suppress	12345	123.45																										
16-bit Signed Decimal	5	2	Zero Suppress	-5	-0.05																										
Alignment	The alignment of the displayed value. There are three types of alignment: Left, Center, and Right.																														
Justification	<p>The justification of the displayed value. There are three types of justification:</p> <table border="1"> <thead> <tr> <th>Option</th> <th>Description</th> </tr> </thead> <tbody> <tr> <td>Zero Suppress</td> <td>The leading digits will not be displayed when they are 0.</td> </tr> <tr> <td>Leading Zeros</td> <td>All digits will be displayed.</td> </tr> <tr> <td>Leading Spaces</td> <td>The leading digits will be displayed as blank characters when they are 0.</td> </tr> </tbody> </table>	Option	Description	Zero Suppress	The leading digits will not be displayed when they are 0.	Leading Zeros	All digits will be displayed.	Leading Spaces	The leading digits will be displayed as blank characters when they are 0.																						
Option	Description																														
Zero Suppress	The leading digits will not be displayed when they are 0.																														
Leading Zeros	All digits will be displayed.																														
Leading Spaces	The leading digits will be displayed as blank characters when they are 0.																														

7.2.4. Advanced Settings

This section describes how to define the advanced settings for a numeric display. The following is an example of the Advanced page of the Numeric Display property sheet.

The following table describes each property in the Advanced page.

Property		Description	
Scaling	<Check Box>	Check this option if you want the value of the monitored variable to be displayed in a scaled manner. The following is the scaling formula. $\text{DisplayedValue} = \text{MonitoredValue} * \text{Gain} + \text{Offset}$ Note: The <i>Gain</i> and <i>Offset</i> are 32-bit floating point numbers. They have at most 6 significant digits. The rounding and truncation may happen.	
	Gain	The <i>Gain</i> of the scaling formula.	
	Offset	The <i>Offset</i> of the scaling formula.	
Range Display	<Check Box>	Check this option if you want the numeric display to display the value with a different color when it is below the specified low limit or above the specified high limit.	
	Variable Range	Check this option if the low limit and high limit are specified by the designated variables at runtime.	
	Low Limit	Specifies the low limit when the Variable Range is not selected. When the Variable Range is selected, this property specifies the variable that stores the low limit at runtime. Click to enter an address. Click to select a tag.	
	High Limit	Specifies the high limit when the Variable Range is not selected. When the Variable Range is selected, this property specifies the variable that stores the high limit at runtime. Click to enter an address. Click to select a tag.	
	High Color	Text Color	The text color for the high limit.
		BG Color	The shape's BG color for the high limit.
	Low Color	Text Color	The text color for the low limit.
BG Color		The shape's BG color for the low limit.	

7.3. Advanced Numeric Displays

7.3.1. Advanced Features

An advanced numeric display provides the following advanced features:

- 1) You can specify an arithmetic expression or a macro for the object to calculate the display value.
- 2) You can specify an arithmetic expression or a macro for the object to convert an operator entered value to an output value.
- 3) You can specify up to 10 ranges for the object to display.

7.3.2. Operation Options

The following operation options can be added to an advanced numeric display. Select and set the options in the Advanced Numeric Display property sheet.

Options	Description
Range Display	The advanced numeric display can support up to 10 fixed ranges or 3 variable ranges. You can define the text color, BG color, and lower bound for each range. At runtime, the advanced numeric display displays the value using color settings for the range to which the value belongs.
Range Check	The advanced numeric display will verify the entered value according to the specified maximum and minimum. If the entered value is not within the allowable range, the value will not be output. Select and set this option in the Range page. Note: If the output expression or the output macro is defined, the converted value stored in the variable \$W is verified instead of the entered value.
Touch Operation Control	You can enable and disable the touch operation of the advanced numeric display by the specified bit or the current user level. Select and set this option in the Advanced page.
Timeout	The keypad displayed for the advanced numeric display will be closed and the data entry operation cancelled after the keypad receives no input for the specified time period.
Notification	The advanced numeric display will notify the specified bit when it finishes outputting the entered value. Select and set this option in the Advanced page.
Operator Confirmation	The Confirmation box will be displayed when a value is entered for the advanced numeric display. If the operator selects "Yes" in the Confirmation box, the advanced numeric display will write the entered value to the specified variable. If the operator selects "No" or the operator does not respond within the specified time period (Maximum Waiting Time), the advanced numeric display will cancel the data entry operation. Select and set this option in the Advanced page.
Operation Logging	The time, the entered value, and the predefined operation message will be recorded when the advanced numeric display outputs the entered value. Select and set this option in the Advanced page.
Visibility Control	You can show and hide the advanced numeric display by the specified bit or the current user level. Select and set this option in the Visibility page.

7.3.3. Settings

You can complete all the settings of an advanced numeric display in the Advanced Numeric Display property sheet. This sheet contains the following seven pages. Some of the pages appear only when they are needed.

- **General**

Described in [Section 7.3.4.](#)

- **Range**

Described in [Section 7.3.5](#)

- **Advanced**

Described in [Section 4.4.5.](#)

- **Visibility**

Described in [Section 4.4.6.](#)

- **External Label**

Described in [Section 4.3.8.](#)

- **Display Macro**

Described in [Section 14.2.6.](#)

- **Output Macro**

Described in [Section 14.2.6.](#)

7.3.4. General Settings





This section describes how to define the general settings for an advanced numeric display. The following is an example of the General page of the Advanced Numeric Display property sheet.

The screenshot shows the 'Advanced Numeric Display' dialog box with the 'General' tab selected. The dialog has a title bar with a close button. Below the title bar are five tabs: 'General', 'Range', 'Advanced', 'Visibility', and 'Output Macro'. The 'General' tab contains the following controls:



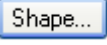

- ID:** AND0000
- Note:** (empty text box)
- Font:** Tw Cen MT (dropdown menu)
- Text Color:** (color selection box)
- Total Digits:** 4 (spin box)
- Fractional Digits:** 0 (spin box)
- Alignment:** Left, Center (selected), Right (radio buttons)
- Justification:** Zero Suppress (selected), Leading Zeros, Leading Spaces (radio buttons)
- Transparent Background:** (checkbox, unchecked)
- Shape...:** (button)
- External Label:** (checkbox, unchecked)
- Border Color:** (color selection box)
- BG Color:** (color selection box)
- Data Type:** 16-Bit Unsigned Integer (dropdown menu)
- Display Type:** 16-Bit Unsigned Decimal (dropdown menu)
- Display:**
 - Monitor Address: (radio button, unselected)
 - Expression: \$D = [(w/80+w/81+w/82+w/83)/4-20] (radio button, selected)
 - Macro (*The value to be displayed should be assigned to \$D) (radio button, unselected)
- Operator Input:** (checkbox, checked)
- Write Address (\$W):** W84
- Output:**
 - Direct: \$W = \$K (\$K represents the keypad input) (radio button, unselected)
 - Expression: (radio button, unselected)
 - Macro (*The value to be output should be assigned to \$W) (radio button, selected)

At the bottom of the dialog are three buttons: 'OK', 'Cancel', and 'Help'.

The following table describes each property in the General page.

Property	Description																								
ID	The object's identifier. It is generated when the object is created. The identifier is unique within the screen where the object is located. The format of the IDs for the advanced numeric displays is ANDnnnn.																								
Note	You can type a note for the object.																								
Transparent Background	Select this option if you want the object to have a transparent background.																								
Shape settings	For details about the following properties, see Section 4.3.4 Setting up the Shape of an Object ,  , Border Color, BG Color																								
External Label	Check this option if you want the object to have an external label. Set up the external label in the External Label page.																								
Data Type	The data type of the variables, arithmetic expressions, and macros of the advanced numeric display. The supported data types include: 16-Bit Unsigned Integer, 32-Bit Unsigned Integer, 16-Bit Signed Integer, 32-Bit Signed Integer, 16-Bit BCD, 32-Bit BCD, 32-Bit Floating Point, 16-Bit Signed BCD (LMB), 32-Bit Signed BCD (LMB), 16-Bit Signed BCD (LMD), and 32-Bit Signed BCD (LMD).																								
Display Type	<p>The display type of the advanced numeric display. The following table shows the available display types for each data type.</p> <table border="1"> <thead> <tr> <th>Data Type</th> <th>Available Display Types</th> </tr> </thead> <tbody> <tr> <td>16-Bit Unsigned Integer</td> <td>16-Bit Unsigned Decimal, 16-Bit Hexadecimal, 16-Bit Octal</td> </tr> <tr> <td>32-Bit Unsigned Integer</td> <td>32-Bit Unsigned Decimal, 32-Bit Hexadecimal, 32-Bit Octal</td> </tr> <tr> <td>16-Bit Signed Integer</td> <td>16-Bit Signed Decimal</td> </tr> <tr> <td>32-Bit Signed Integer</td> <td>32-Bit Signed Decimal</td> </tr> <tr> <td>16-Bit BCD</td> <td>16-Bit Unsigned Decimal</td> </tr> <tr> <td>32-Bit BCD</td> <td>32-Bit Unsigned Decimal</td> </tr> <tr> <td>32-Bit Floating Point</td> <td>32-Bit Floating Point</td> </tr> <tr> <td>16-Bit Signed BCD (LMB)</td> <td>16-Bit Signed Decimal</td> </tr> <tr> <td>32-Bit Signed BCD (LMB)</td> <td>32-Bit Signed Decimal</td> </tr> <tr> <td>16-Bit Signed BCD (LMD)</td> <td>16-Bit Signed Decimal</td> </tr> <tr> <td>32-Bit Signed BCD (LMD)</td> <td>32-Bit Signed Decimal</td> </tr> </tbody> </table>	Data Type	Available Display Types	16-Bit Unsigned Integer	16-Bit Unsigned Decimal, 16-Bit Hexadecimal, 16-Bit Octal	32-Bit Unsigned Integer	32-Bit Unsigned Decimal, 32-Bit Hexadecimal, 32-Bit Octal	16-Bit Signed Integer	16-Bit Signed Decimal	32-Bit Signed Integer	32-Bit Signed Decimal	16-Bit BCD	16-Bit Unsigned Decimal	32-Bit BCD	32-Bit Unsigned Decimal	32-Bit Floating Point	32-Bit Floating Point	16-Bit Signed BCD (LMB)	16-Bit Signed Decimal	32-Bit Signed BCD (LMB)	32-Bit Signed Decimal	16-Bit Signed BCD (LMD)	16-Bit Signed Decimal	32-Bit Signed BCD (LMD)	32-Bit Signed Decimal
Data Type	Available Display Types																								
16-Bit Unsigned Integer	16-Bit Unsigned Decimal, 16-Bit Hexadecimal, 16-Bit Octal																								
32-Bit Unsigned Integer	32-Bit Unsigned Decimal, 32-Bit Hexadecimal, 32-Bit Octal																								
16-Bit Signed Integer	16-Bit Signed Decimal																								
32-Bit Signed Integer	32-Bit Signed Decimal																								
16-Bit BCD	16-Bit Unsigned Decimal																								
32-Bit BCD	32-Bit Unsigned Decimal																								
32-Bit Floating Point	32-Bit Floating Point																								
16-Bit Signed BCD (LMB)	16-Bit Signed Decimal																								
32-Bit Signed BCD (LMB)	32-Bit Signed Decimal																								
16-Bit Signed BCD (LMD)	16-Bit Signed Decimal																								
32-Bit Signed BCD (LMD)	32-Bit Signed Decimal																								
Display	Monitor Address	<p>Select this option so the advanced numeric display will monitor the variable specified in the Monitor Address field and display its value. When this option is selected, you need to specify the monitored variable.</p> <p>Click  to enter an address for this field. Click  to select a tag for this field.</p>																							
	Expression	<p>Select this option so the advanced numeric display will display the result of the arithmetic expression specified in the Expression field. When this option is selected, you need to specify the arithmetic expression that calculates the value to be displayed.</p> <p>Click  to enter an address for this field. Click  to select a tag for this field.</p>																							
	Macro	Select this option so the advanced numeric display will run the macro defined in the Display Macro page before displaying the value of the internal variable \$D. The macro can decide the value displayed by saving the desired value in the internal variable \$D.																							
Operator Input	Select this option so the advanced numeric display will allow the operator to enter values for it.																								

Continued

Property		Description																																																												
Write Address		Specifies the destination variable where the entered value will be written to when the Operator Input is selected. Click  to enter an address for this field. Click  to select a tag for this field.																																																												
Output	Direct	Select this option so the advanced numeric display will write the entered value to the destination variable specified in the Write Address field directly.																																																												
	Expression	Select this option so the advanced numeric display will write the result of the arithmetic expression specified in the Expression field. When this option is selected, you need to specify the arithmetic expression that calculates the value to be output. To use the entered value as an operand in the expression, specify the internal variable \$K for the entered value. Click  to enter an address for this field. Click  to select a tag for this field.																																																												
	Macro	Select this option so the advanced numeric display will run the macro defined in the Output Macro page before writing the value of the internal variable \$W to the destination variable. The macro can decide the value to be output by saving the desired value in the internal variable \$W. To use the entered value in macro commands as a parameter, specify the internal variable \$K for the entered value.																																																												
Font		The font of the displayed value.																																																												
Text Color		The color of the displayed value.																																																												
Total Digits		The number of digits to be displayed. Note: This property applies to the display of the initial value, the allowable minimum, and the allowable maximum on the numeric keypad.																																																												
Fractional Digits		<p>When the Display Type is 32-bit Floating Point, this property specifies the number of fractional digits to be displayed.</p> <p>When the Display Type is not 32-bit Floating Point, this property specifies not only the number of fractional digits to be displayed, but also the number of least significant digits to be displayed as the fractional part. With this feature, an integer can be shown and entered as a fixed point number. When the Fractional Digits is nonzero, say N, the entered value will be converted to an integer according to the following formula before being output.</p> $\text{OutputValue} = \text{EnteredValue} * (N^{\text{th}} \text{ power of } 10)$ <p>Example 1:</p> <table border="1"> <thead> <tr> <th>Display Type</th> <th>Total Digits</th> <th>Fractional Digits</th> <th>Justification</th> <th>Monitored Value</th> <th>Displayed Value</th> </tr> </thead> <tbody> <tr> <td>32-bit Floating Point</td> <td>4</td> <td>2</td> <td>Zero Suppress</td> <td>12.34</td> <td>12.34</td> </tr> <tr> <td>32-bit Floating Point</td> <td>4</td> <td>2</td> <td>Zero Suppress</td> <td>123.4</td> <td>23.40</td> </tr> <tr> <td>16-bit Signed Decimal</td> <td>5</td> <td>2</td> <td>Zero Suppress</td> <td>12345</td> <td>123.45</td> </tr> <tr> <td>16-bit Signed Decimal</td> <td>5</td> <td>2</td> <td>Zero Suppress</td> <td>-5</td> <td>-0.05</td> </tr> </tbody> </table> <p>Example 2:</p> <table border="1"> <thead> <tr> <th>Display Type</th> <th>Total Digits</th> <th>Fractional Digits</th> <th>Entered Value</th> <th>Output Value</th> </tr> </thead> <tbody> <tr> <td>32-bit Floating Point</td> <td>4</td> <td>2</td> <td>12.34</td> <td>12.34</td> </tr> <tr> <td>32-bit Floating Point</td> <td>4</td> <td>2</td> <td>123.4</td> <td>Error!</td> </tr> <tr> <td>16-bit Signed Decimal</td> <td>5</td> <td>2</td> <td>123.45</td> <td>12345</td> </tr> <tr> <td>16-bit Signed Decimal</td> <td>5</td> <td>2</td> <td>-0.05</td> <td>-5</td> </tr> <tr> <td>16-bit Signed Decimal</td> <td>5</td> <td>2</td> <td>3</td> <td>300</td> </tr> </tbody> </table> <p>Note: This property applies to the display of the initial value, the allowable minimum, and the allowable maximum on the numeric keypad.</p>	Display Type	Total Digits	Fractional Digits	Justification	Monitored Value	Displayed Value	32-bit Floating Point	4	2	Zero Suppress	12.34	12.34	32-bit Floating Point	4	2	Zero Suppress	123.4	23.40	16-bit Signed Decimal	5	2	Zero Suppress	12345	123.45	16-bit Signed Decimal	5	2	Zero Suppress	-5	-0.05	Display Type	Total Digits	Fractional Digits	Entered Value	Output Value	32-bit Floating Point	4	2	12.34	12.34	32-bit Floating Point	4	2	123.4	Error!	16-bit Signed Decimal	5	2	123.45	12345	16-bit Signed Decimal	5	2	-0.05	-5	16-bit Signed Decimal	5	2	3	300
Display Type	Total Digits	Fractional Digits	Justification	Monitored Value	Displayed Value																																																									
32-bit Floating Point	4	2	Zero Suppress	12.34	12.34																																																									
32-bit Floating Point	4	2	Zero Suppress	123.4	23.40																																																									
16-bit Signed Decimal	5	2	Zero Suppress	12345	123.45																																																									
16-bit Signed Decimal	5	2	Zero Suppress	-5	-0.05																																																									
Display Type	Total Digits	Fractional Digits	Entered Value	Output Value																																																										
32-bit Floating Point	4	2	12.34	12.34																																																										
32-bit Floating Point	4	2	123.4	Error!																																																										
16-bit Signed Decimal	5	2	123.45	12345																																																										
16-bit Signed Decimal	5	2	-0.05	-5																																																										
16-bit Signed Decimal	5	2	3	300																																																										

Continued

Property	Description	
Alignment	The alignment of the displayed value. There are three types of alignment: Left, Center, and Right.	
Justification	The justification of the displayed value. There are three types of justification:	
	Option	Description
	Zero Suppress	The leading digits will not be displayed when they are 0.
	Leading Zeros	All digits will be displayed.
	Leading Spaces	The leading digits will be displayed as blank characters when they are 0.

7.3.5. Range Settings

This section describes how to define the range settings for an advanced numeric display. The following is an example of the Range page of the Advanced Numeric Display property sheet.









The screenshot shows the 'Range' tab of the Advanced Numeric Display property sheet. It is divided into two main sections: 'Range Display' and 'Range Check'.

Range Display: This section is checked. It includes a checkbox for 'Variable Bounds (3 ranges)' which is unchecked. Below it, 'Number of Ranges' is set to 7. A table lists 7 ranges with their respective lower bounds, text colors, background colors, and blink settings.

Range No.	Lower Bound	Text Color	BG Color	Blink
1 (Highest)	9000	Black	Light Gray	<input checked="" type="checkbox"/>
2	8000	Black	Light Gray	<input type="checkbox"/>
3	7000	Black	Light Gray	<input type="checkbox"/>
4	6000	Black	Light Gray	<input type="checkbox"/>
5	5000	Black	Light Gray	<input type="checkbox"/>
6	4000	Black	Light Gray	<input type="checkbox"/>
7 (Lowest)		Black	Light Gray	<input checked="" type="checkbox"/>

Range Check: This section is checked. It includes a checkbox for 'Variable Range' which is checked. Below it, 'Min.' is set to W64 and 'Max.' is set to W65. Both fields have calculator and help icons.

The following table describes each property in the Range page.

Property		Description	
Range Display	Range Display	Check this option if you want the advanced numeric display to support the range display. The advanced numeric display can support up to 10 fixed ranges or 3 variable ranges. You can define the text color, BG color, and lower bound for each range. At runtime, the monitored value within a range will be displayed with the color setting for that range.	
	Variable Bound (3 ranges)	Check this option so the lower bounds of range 1 and range 2 will be determined at runtime by the variables specified in the Lower Bound fields for Range 1 and Range 2. The advanced numeric display supports 3 ranges when Variable Bound is selected. When Variable Bound is not selected, the advanced numeric display can support up to 10 ranges. You need to specify the lower bounds for every range except the lowest range.	
	Number of Ranges	The number of ranges that the advanced numeric display supports.	
	Range 1 (Highest)	Lower Bound	Specifies the lower bound of range 1 when Variable Bound is not selected. When Variable Bound is selected, this property specifies the variable whose value will be the lower bound of range 1 at runtime. Click  to enter an address for this field. Click  to select a tag for this field.
		Text Color	The text color for range 1.
		BG Color	The shape's BG color for range 1.
		Blink	Check the item when you want range 1 to be displayed as blinking.
	Range 2	Lower Bound	Specifies the lower bound of range 2 when Variable Bound is not selected. When Variable Bound is selected, this property specifies the variable whose value will be the lower bound of range 2 at runtime. Click  to enter an address for this field. Click  to select a tag for this field.
		Text Color	The text color for range 2.
		BG Color	The shape's BG color for range 2.
		Blink	Check the item when you want range 2 to be displayed as blinking.
	Range 3 to Range 10	Lower Bound	Specifies the lower bound of the corresponding range when the range is not the lowest range.
		Text Color	The text color for the corresponding range.
BG Color		The shape's BG color for the corresponding range.	
Blink		Check the item when you want the corresponding range to be displayed as blinking.	
Range Check	Range Check	Check this option if you want the advanced numeric display to verify the entered value according to the specified minimum and maximum. If the entered value is not within the allowable range, the entered value will not be output. Note: If the output expression or the output macro is defined, the converted value stored in the variable \$W is verified instead of the entered value.	
	Variable Range	Check this option so the minimum and maximum will be determined at runtime by the variables specified in the Minimum and Maximum fields.	
	Min.	Specifies the minimum when the Variable Range is not selected. When the Variable Range is selected, this property specifies the variable whose value is the minimum. Click  to enter an address for this field. Click  to select a tag for this field.	
	Max.	Specifies the maximum when the Variable Range is not selected. When the Variable Range is selected, this property specifies the variable whose value is the maximum. Click  to enter an address for this field. Click  to select a tag for this field.	

7.4. Character Entries

You can enter a string for a variable using a character entry. If the target panel is a PC, you can also use this object to enter a Unicode string.

7.4.1. Operation Options

The following operation options can be added to a character entry. Select and set up the options in the Character Entry property sheet.

Option	Description
Touch Operation Control	You can enable or disable the touch operation of the object by the specified bit or by the current user level. Select and set up this option in the Advanced page.
Timeout	If the keypad for data entry receives no input for the specified time period, the data entry operation will be cancelled.
Notification	The Object will notify the specified bit of a successful data entry operation. Select and set up this option in the Advanced page.
Operator Confirmation	When a character string is entered by the operator, the Confirmation box will be displayed for the operator's confirmation. If the operator selects "Yes", the object will write the entered data to the specified variable. If the operator selects "No" or the operator does not respond within the specified time period (Maximum Waiting Time), the data entry operation will be cancelled. Select and set up this option in the Advanced page.
Operation Logging	The entered character string and time of data entry will be recorded. Select and set up this option in the Advanced page.
Visibility Control	You can show or hide the object by the specified bit or by the current user level. Select and set up this option in the Visibility page.

7.4.2. Settings

You can complete all the settings of a character entry in the Character Entry property sheet. This sheet contains the following four pages. Some of the pages appear only when they are needed.

- **General**

Described in [Section 7.4.3.](#)

- **Advanced**

Described in [Section 7.4.4.](#)

- **Visibility**

Described in [Section 4.4.6.](#)

- **External Label**

Described in [Section 4.3.8.](#)

7.4.3. General Settings



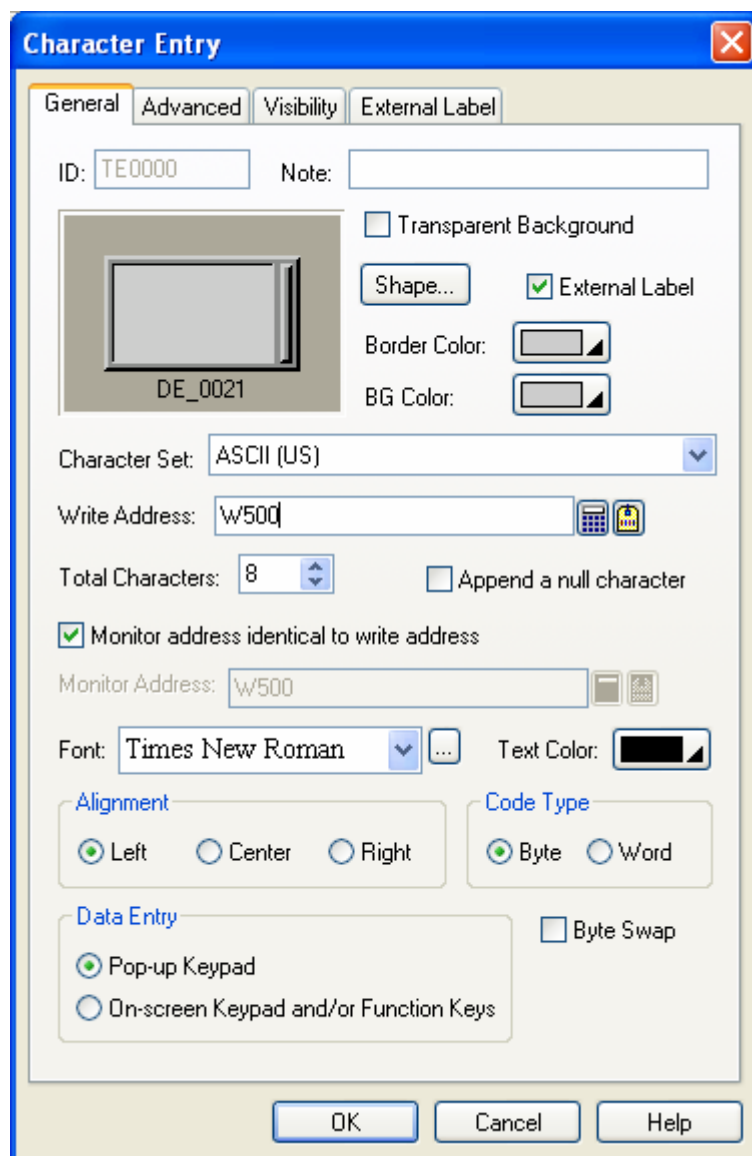
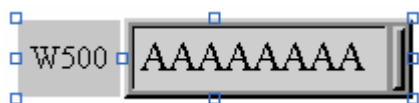

This section describes how to define the general settings for character entries. The following is an example of the General page of the Character Entry property sheet.



The following table describes each property in the General page.

Property	Description
ID	The object's identifier. It is generated when the object is created. The identifier is unique within the screen where the object is located. The format of the IDs for Character entries is TEnnnn.
Note	You can type a note for the object.
Transparent Background	Select this option if you want the object to have a transparent background.
Shape settings	For details about the following properties, see Section 4.3.4 Setting up the Shape of an Object .  , Border Color, BG Color

Continued



Property	Description								
External Label	Check this option if you want the object to have an external label. Set up the external label in the External Label page.								
Character Set	<p>Select one of the following three character sets to encode characters into a string of code units</p> <table border="1"> <thead> <tr> <th>Character Set</th> <th>Description</th> </tr> </thead> <tbody> <tr> <td>ASCII (US)</td> <td>Defines 128 characters. Uses 8 or 16 bits per character.</td> </tr> <tr> <td>ISO-8859-1 (Western European)</td> <td>Covers mostly Western European languages. Uses 8 or 16 bits per character.</td> </tr> <tr> <td>Unicode</td> <td>Available only when the target panel is a PC. Each character occupies one word and the code is Unicode.</td> </tr> </tbody> </table>	Character Set	Description	ASCII (US)	Defines 128 characters. Uses 8 or 16 bits per character.	ISO-8859-1 (Western European)	Covers mostly Western European languages. Uses 8 or 16 bits per character.	Unicode	Available only when the target panel is a PC. Each character occupies one word and the code is Unicode.
Character Set	Description								
ASCII (US)	Defines 128 characters. Uses 8 or 16 bits per character.								
ISO-8859-1 (Western European)	Covers mostly Western European languages. Uses 8 or 16 bits per character.								
Unicode	Available only when the target panel is a PC. Each character occupies one word and the code is Unicode.								
Write Address	<p>Specifies the destination variable where the entered character string will be written to.</p> <p>Click  to enter an address for this field. Click  to select a tag for this field.</p>								
Total Characters	Specifies the number of characters that the Character entry can display and the destination variable can receive.								
Append a null character	Check this option so the Character entry will always append a null character to the entered character string before outputting it.								
Monitor Address identical to Write Address	Specifies that the monitored variable is the same as the destination variable. With this item checked, you don't need to specify the monitored variable in the Monitor Address field.								
Monitor Address	<p>Specifies the monitored variable.</p> <p>Click  to enter an address for this field. Click  to select a tag for this field.</p>								
Font	The font of the displayed string.								
Text Color	The color of the displayed string.								
Alignment	The alignment of the displayed value. There are three types of alignment: Left, Center, and Right.								
Code Type	<p>Select one of the following two code types.</p> <table border="1"> <thead> <tr> <th>Type</th> <th>Description</th> </tr> </thead> <tbody> <tr> <td>Byte</td> <td>Each character occupies one byte.</td> </tr> <tr> <td>Word</td> <td>Each character occupies one word.</td> </tr> </tbody> </table> <p>Available only when the character set is ASCII (US) or ISO-8859-1 (Western European).</p>	Type	Description	Byte	Each character occupies one byte.	Word	Each character occupies one word.		
Type	Description								
Byte	Each character occupies one byte.								
Word	Each character occupies one word.								
Data Entry	<p>Specifies how to enter a character string for the Character entry at runtime. There are two options:</p> <table border="1"> <thead> <tr> <th>Option</th> <th>Description</th> </tr> </thead> <tbody> <tr> <td>Pop-up Keypad</td> <td>You can bring up the keypad by pressing the Character entry, and then enter a character string with the keypad.</td> </tr> <tr> <td>On-screen Keypad and/or Function Keys</td> <td>You can move the cursor by using the function buttons with the operation of "Select Next Data Entry Object" or "Select Previous Data Entry Object" to select the Character entry. If there is an on-screen keypad, you can enter a character string for the Character entry with that keypad.</td> </tr> </tbody> </table> <p>Note: When the On-screen Keypad and/or Function Keys option is selected, you can only enter a character string for the Character entry with the input focus. To set the input focus to the corresponding object, you need to click that object first.</p>	Option	Description	Pop-up Keypad	You can bring up the keypad by pressing the Character entry, and then enter a character string with the keypad.	On-screen Keypad and/or Function Keys	You can move the cursor by using the function buttons with the operation of "Select Next Data Entry Object" or "Select Previous Data Entry Object" to select the Character entry. If there is an on-screen keypad, you can enter a character string for the Character entry with that keypad.		
Option	Description								
Pop-up Keypad	You can bring up the keypad by pressing the Character entry, and then enter a character string with the keypad.								
On-screen Keypad and/or Function Keys	You can move the cursor by using the function buttons with the operation of "Select Next Data Entry Object" or "Select Previous Data Entry Object" to select the Character entry. If there is an on-screen keypad, you can enter a character string for the Character entry with that keypad.								
Byte Swap	Check this option to display high byte first and then low byte.								

7.4.4. Advanced Settings

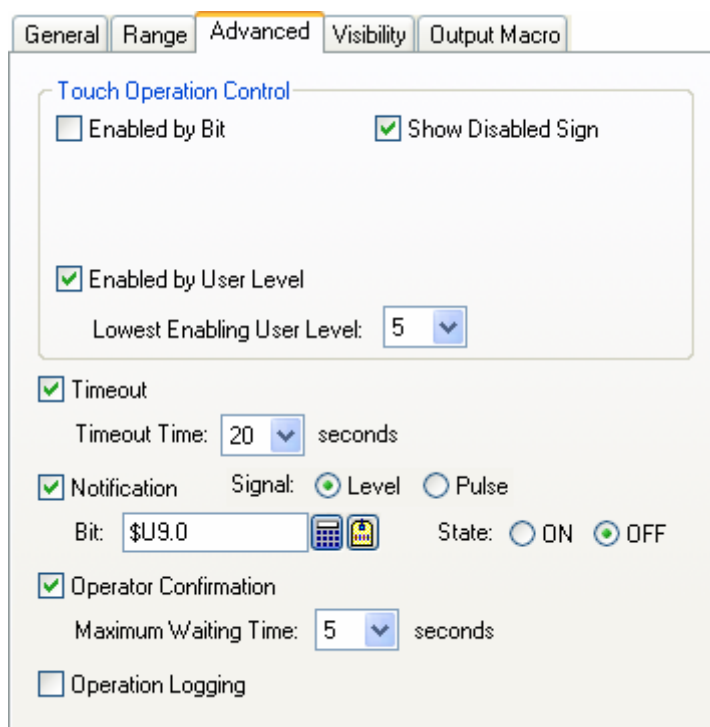
This section describes how to define the advanced settings for character entries. The following is an example of the Advanced page.



The following table describes each property in the Advanced page.

Property		Description
Touch Operation Control	Enabled by Bit	Check this option so the touch operation of the Character entry will be enabled and disabled by the specified bit.
	Control Bit	Specifies the bit that enables and disables the touch operation. Click  to enter a bit address. Click  to select a bit tag.
	Enabling State	Specifies the state (On or Off) that enables the touch operation.
	Enabled by User Level	Check this item so the touch operation of the Character entry will be enabled and disabled by the current user level.
	Lowest Enabling User Level	Specifies the lowest user level that is required to enable the touch operation.
	Show Disabled Sign	Check this option for the touch operation disabled sign to be displayed on the Character entry when the touch operation is disabled.
Timeout	Timeout	Check this option so data entry will be cancelled if the numeric keypad does not receive any input within the specified time.
	Timeout Time	Specifies the maximum time that the numeric keypad will wait to receive a new input. If there is no input within the specified time, the Character keypad will be closed and data entry will be cancelled.

Continued

Property		Description							
Notification	Notification	Check this option so the Character entry will notify the specified bit after it finishes outputting the entered value to the destination variable.							
	Signal	Select one of the following signals for the notification:							
		<table border="1"> <thead> <tr> <th>Signal</th> <th>Description</th> </tr> </thead> <tbody> <tr> <td>Level</td> <td>Set the specified bit to the specified state.</td> </tr> <tr> <td>Pulse</td> <td>Send a positive pulse to the specified bit.</td> </tr> </tbody> </table>		Signal	Description	Level	Set the specified bit to the specified state.	Pulse	Send a positive pulse to the specified bit.
		Signal	Description						
	Level	Set the specified bit to the specified state.							
Pulse	Send a positive pulse to the specified bit.								
Bit	Specifies the bit that receives the notification.								
State	Specifies the state (On or Off) that is used for the notification.								
Operator Confirmation	Operator Confirmation	Check this option if you want the operator to confirm what he/she enters into the numeric entry. The Confirmation box will be displayed when a value is entered into the Character entry. If the operator selects "Yes" in the Confirmation box, the numeric entry will write the entered value to the specified variable. If the operator selects "No" or the operator does not respond within the specified time period (Maximum Waiting Time), the Character entry will cancel the data entry operation.							
	Maximum Waiting Time	Specifies the maximum time that the Character entry will wait for the operator's confirmation. Data entry will be cancelled if the operator does not respond within this time.							
Operation Logging	Operation Logging	Check this option so the following three items will be recorded in the operation log when the Character entry outputs the entered value. There are three recorded items: 1) The time when the operation is performed 2) The entered Character 3) The predefined operation message							
	Message	Enter the operation message of the first language here.							
		Click this button to bring up the Operation Message dialog box so that you can edit the operation message for all the languages.							

7.5. Character Displays

You can use a character display to display the string stored in a variable. This object can display Unicode string if the target panel is a PC.

Note: The difference between a character display and a text object is:

A character display is used either to display text, request text, or both. The text of the Character display is not allowed to be set at design time but can easily be set at run time. You can specify the text by changing its defined variable.

A text object can be used to create a label at design time, which is a short text that accompanies another control to indicate its use. The text object cannot be changed at run time.

7.5.1. Operation Options

The following operation option can be added to a character display. Select and set up the option in the Character Display property sheet.

Options	Description
Visibility Control	You can show or hide the Character display by the specified bit or by the current user level. Select and set up this option in the Visibility page.

7.5.2. Settings

You can complete all the settings of a character display in the Character Display property sheet. This sheet contains the following three pages. Some of the pages appear only when they are needed.

- **General**

Described in [Section 7.5.3.](#)

- **Visibility**

Described in [Section 4.4.6.](#)

- **External Label**



Described in [Section 4.3.8.](#)

7.5.3. General Settings

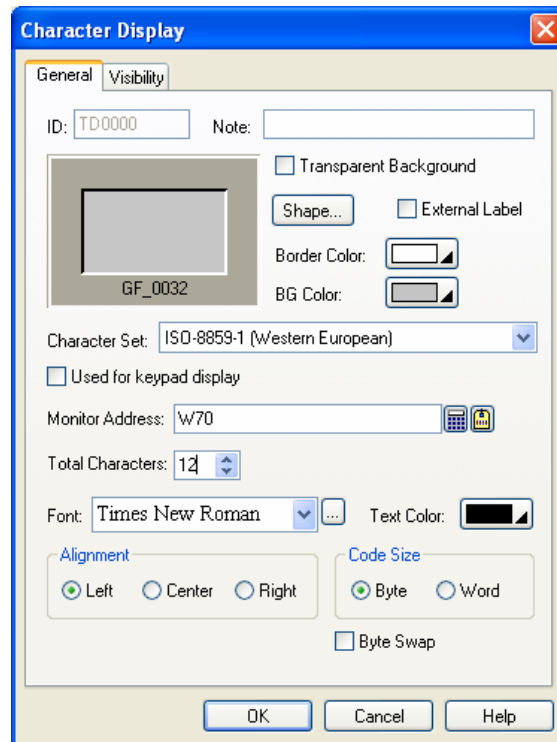
This section describes how to define the general settings for character displays. The following is an example of the General page of the Character Display property sheet.



The following table describes each property in the General page.

Property	Description
ID	The object's identifier. It is generated when the object is created. The identifier is unique within the screen where the object is located. The format of the IDs for Character displays is TDnnnn.
Note	You can type a note for the object.
Transparent Background	Select this option if you want the object to have a transparent background.
Shape settings	For details about the following properties, see Section 4.3.4 Setting up the Shape of an Object .  , Border Color, BG Color
External Label	Check this option if you want the object to have an external label. Set up the external label in the External Label page.
Character Set	The types of character codes of the string in the monitored variable. You can select ASCII(US) code or ISO-8859-1(Western European). If the target panel is a PC, the Unicode is also an option.
Used for keypad display	Check this option if the character display is used to display the input for a custom keypad.
Monitor Address	Specifies the monitored variable. Click  to enter an address for this field. Click  to select a tag for this field.
Total Characters	Specifies the number of characters that the Character display can display.
Font	The font of the displayed string.
Text Color	The color of the displayed string.
Alignment	The alignment of the displayed value. There are three types of alignment: Left, Center, and Right.
Code Size	The size of each character. You can select Byte or Word.
Byte Swap	Check this option to display high byte first and then low byte.

7.6. Time Displays

You can use a time display to show the time of the panel.

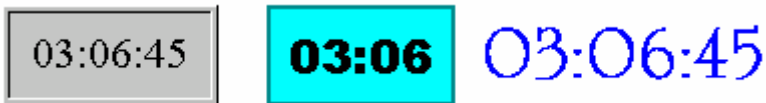

7.6.1. Settings

You can complete all the settings of a time display in the Time Display property sheet. The following is an example of the sheet.

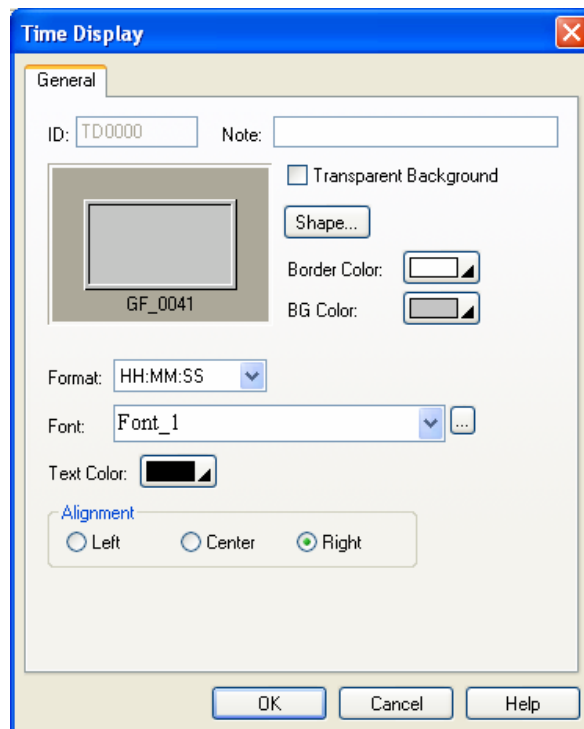

The following table describes each property in the General page.

Property	Description						
ID	The object's identifier. It is generated when the object is created. The identifier is unique within the screen where the object is located. The format of the IDs for the time displays is TDnnnn.						
Note	You can type a note for the object.						
Transparent Background	Select this option if you want the object to have a transparent background.						
Shape settings	For details about the following properties, see Section 4.3.4 Setting up the Shape of an Object .  , Border Color, BG Color						
Format	The format of how the time is displayed. There are two formats available. <table border="1" data-bbox="319 1792 1241 1921"> <thead> <tr> <th>Format</th> <th>Description</th> </tr> </thead> <tbody> <tr> <td>HH:MM</td> <td>HH: 00-23 (hour); MM: 00-59 (minute)</td> </tr> <tr> <td>HH:MM:SS</td> <td>HH: 00-23 (hour); MM: 00-59 (minute); SS: 00-59 (second)</td> </tr> </tbody> </table>	Format	Description	HH:MM	HH: 00-23 (hour); MM: 00-59 (minute)	HH:MM:SS	HH: 00-23 (hour); MM: 00-59 (minute); SS: 00-59 (second)
Format	Description						
HH:MM	HH: 00-23 (hour); MM: 00-59 (minute)						
HH:MM:SS	HH: 00-23 (hour); MM: 00-59 (minute); SS: 00-59 (second)						
Font	The font of the text.						
Text Color	The color of the text.						
Alignment	The alignment of the text in the object. There are three kinds of alignment available: Left, Center, and Right.						

7.7. Date Displays

You can use a date display to show the date of the panel.

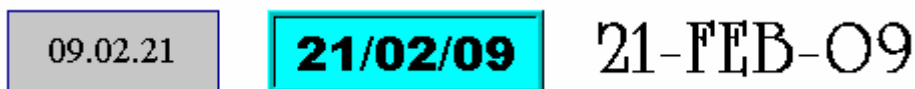

7.7.1. Settings

You can complete all the settings of a date display in the Date Display property sheet. The following is an example of the sheet.

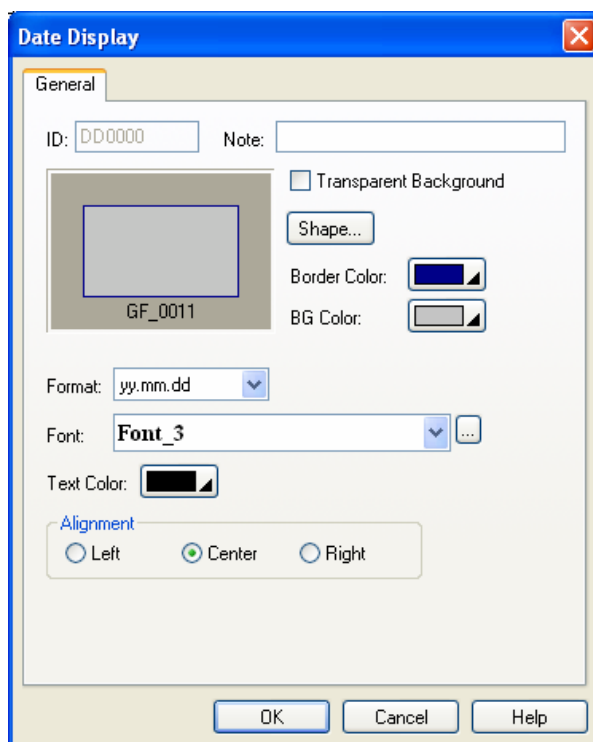

The following table describes each property in the General page.

Property	Description
ID	The object's identifier. It is generated when the object is created. The identifier is unique within the screen where the object is located. The format of the IDs for the date displays is DDnnnn.
Note	You can type a note for the object.
Transparent Background	Select this option if you want the object to have a transparent background.
Shape settings	For details about the following properties, see Section 4.3.4 Setting up the Shape of an Object . Shape... , Border Color, BG Color
Format	The format of how the date is displayed. There are 12 formats available: dd/mm/yy, mm/dd/yy, yy/mm/dd, dd.mm.yy, mm.dd.yy, yy.mm.dd, dd-mm-yy, mm-dd-yy, yy-mm-dd, dd-MMM-yy, MMM-dd-yy, and yy-MMM-dd. To change the date display format, choose one from the drop-down table. Note: dd: 01-31 (day); mm: 01-12 (month); yy: 00-99 (year); MMM: JAN-DEC (month)
Font	The font of the text.
Text Color	The color of the text.
Alignment	The alignment of the text in the object. There are three kinds of alignment available: Left, Center, and Right.

7.8. Day-of-week Displays

You can use a day-of-week display to show the day-of-week of the panel.



7.8.1. Settings

You can complete all the settings of a day-of-week display in the Day-of-week Display property sheet. This sheet contains the following two pages.

- **General**

Described in [Section 7.8.2](#).

- **Text**

Described in [Section 4.3.6](#).

Note: When using the Text page to specify the text for each day, note that state 0 corresponds to Sunday, state 1 corresponds to Monday, and so on.

7.8.2. General Settings

This section describes how to define the general settings for a day-of-week display. The following is an example of the General page of the Day-of-week property sheet.

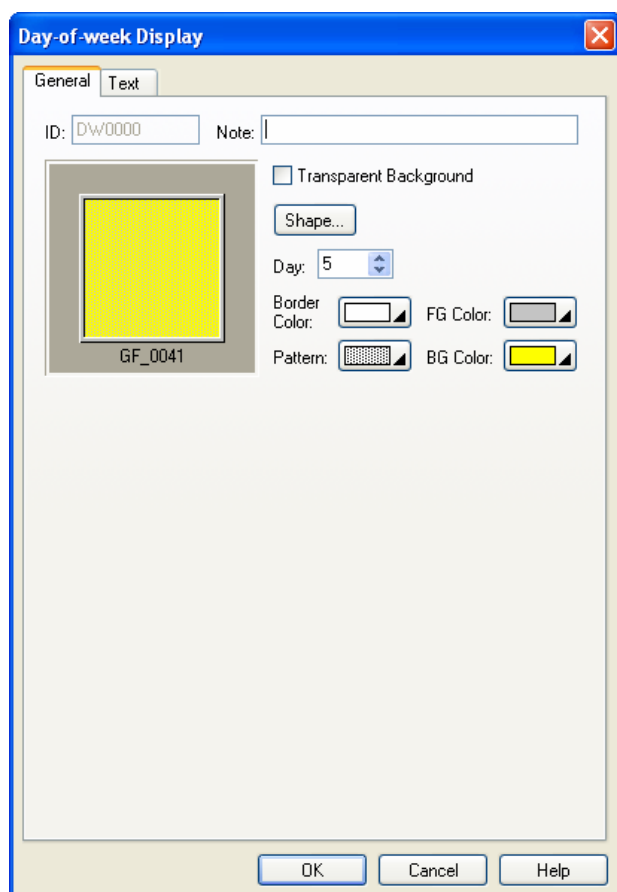

The following table describes each property in the General page.

Property	Description
ID	The object's identifier. It is generated when the object is created. The identifier is unique within the screen where the object is located. The format of the IDs for the day-of-week displays is DWnnnn.
Note	You can type a note for the object.
Transparent Background	Select this option if you want the object to have a transparent background.
Shape settings	For details about the following properties, see Section 4.3.4 Setting up the Shape of an Object . Shape... , Border Color, Pattern, FG Color, BG Color
Day	Select a day from 0 to 6 so you can view and set the Pattern, FG Color, and BG Color for that day. Day 0 corresponds to Sunday; day 1 corresponds to Monday, and so on.

CHAPTER 8

GRAPHS AND CHARTS

8.1. Bar Graphs	1
8.1.1. Basic Operations.....	1
8.1.2. Operation Options.....	2
8.1.3. Settings	3
8.1.4. General Settings.....	4
8.1.5. Forward and Backward Marker Settings	6
8.1.6. Advanced Settings	8
8.2. Meters	9
8.2.1. Basic Operations.....	9
8.2.2. Operation Options.....	10
8.2.3. Settings	10
8.2.4. General Settings.....	11
8.2.5. Range Settings	14
8.3. Circular Bar Graphs	15
8.3.1. Basic Operations.....	15
8.3.2. Operation Options.....	16
8.3.3. Settings	16
8.3.4. General Settings.....	17
8.4. Line Charts	19
8.4.1. Basic Operations.....	19
8.4.2. Operation Options.....	20
8.4.3. Settings	20
8.4.4. General Settings.....	21
8.4.5. Pen Settings	26
8.4.6. Axis Settings.....	27
8.5. Scatter Charts	29
8.5.1. Basic Operations.....	29
8.5.2. Operation Options.....	29
8.5.3. Settings	30
8.5.4. General Settings.....	31
8.5.5. Pen Settings	35

8.1. Bar Graphs

8.1.1. Basic Operations

A bar graph shows the value of a monitored variable by displaying a bar with variable length. When the value of the variable increases or decreases, the length of the bar increases or decreases accordingly. A bar graph can have a scale and the scale enables you to measure the length of the bar and read the current value of the monitored variable.

There are two bar types that a bar graph can have: a polar bar and a bipolar bar. The polar bar can only move at one end, but the bipolar bar can move both ends. The bar and the scale can be displayed in any of the following four directions:

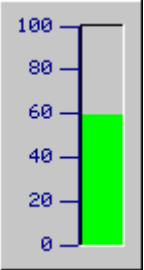
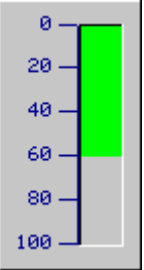
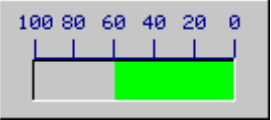
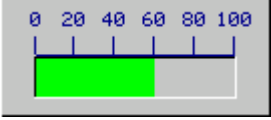
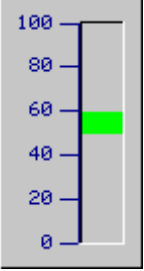
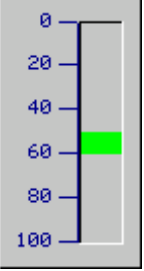
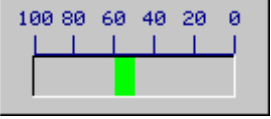
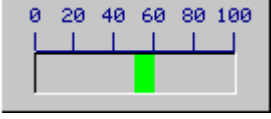
Type	Upward	Downward	Leftward	Rightward
Polar Bar (Monitored Value = 60)				
Bipolar Bar (Monitored Value = 60 Middle Point = 50)				

A bar graph can also have a scale, forward markers, backward markers and a percentage display.

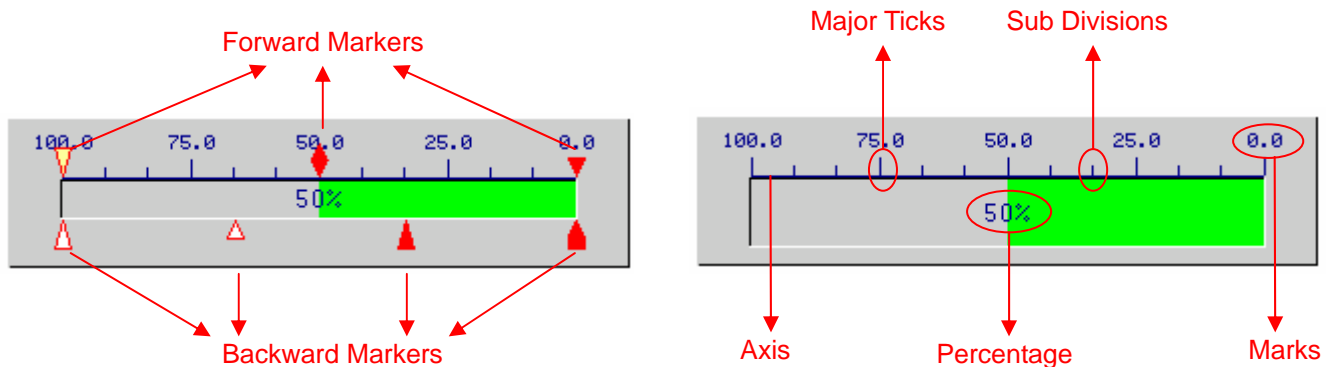

Note:

- The bipolar bar graph does not have forward and backward markers.
- If the bar graph is upward or downward, the scale and forward/backward markers will be located on the left or right sides.
- If the bar graph is leftward or rightward, the scale and forward/backward markers will be located at the top or bottom.

8.1.2. Operation Options

The following operation options can be added to a bar graph to make it more informative. You need to select and set these options in the Bar Graph property sheet.

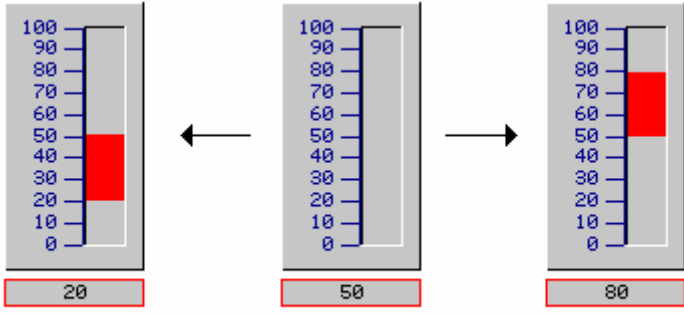
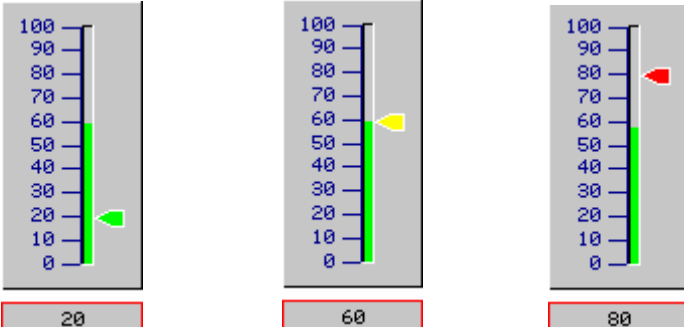
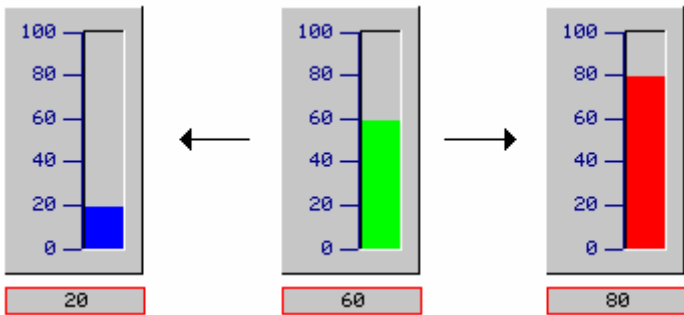
Options	Description
Bipolar Bar	<p>A bar graph can be configured to display the difference between the monitored value and a specified value called the middle point. The bar can move at both ends, hence bipolar bar.</p>  <p style="text-align: center;">Middle Point = 50</p> <p style="text-align: right;">Monitored Value</p> <p>Select and set this option in the General page.</p>
Scale	<p>A bar graph can have a scale. Select and set this option in the Scale page.</p>
Forward / Backward Marker	<p>The forward/backward markers of a bar graph can have up to 12 marks. You can select equilateral triangle, triangle, diamond, or cone as the mark. The actual number of marks and the value of each mark is specified at runtime by the forward/backward marker control block. The position of a mark is determined by that mark's value. The color of a mark is determined by comparing the monitored value to the mark's value.</p>  <p style="text-align: right;">Monitored Value = 60</p> <p style="text-align: right;">The color of a mark:</p> <ul style="list-style-type: none"> LT Color = Light Red EQ Color = Yellow GT Color = Light Green <p style="text-align: right;">Mark's Value</p> <p>Select and set Forward Marker option in the F. Marker page.</p> <p>Select and set Backward Marker option in the B. Marker page.</p>
Range Display	<p>You can specify a low limit and a high limit for a bar graph. The limits can be constants or variables. At runtime, when the monitored value is equal to or below the low limit, the bar graph shows the bar with the FG color and the BG color set for the low limit. When the monitored value is equal to or above the high limit, the bar graph shows the bar with the FG color and the BG color set for the high limit.</p>  <p style="text-align: right;">Low Limit = 20</p> <p style="text-align: right;">High Limit = 80</p> <p style="text-align: right;">Low BG Color = Light Blue</p> <p style="text-align: right;">High BG Color = Light red</p> <p style="text-align: right;">Monitored Value</p> <p>Select and set this option in the Advanced page.</p>

Continued

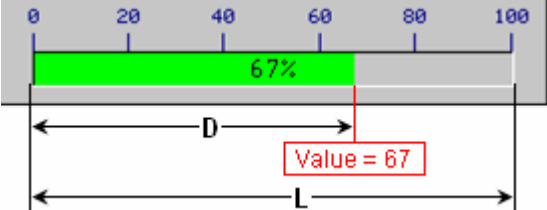
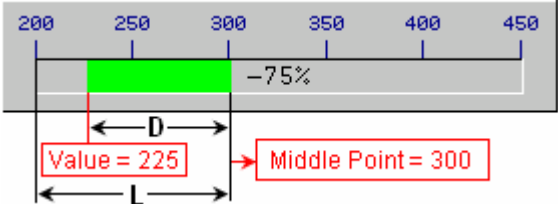
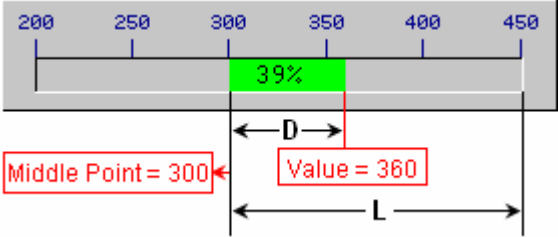
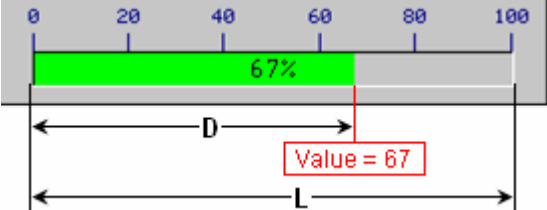
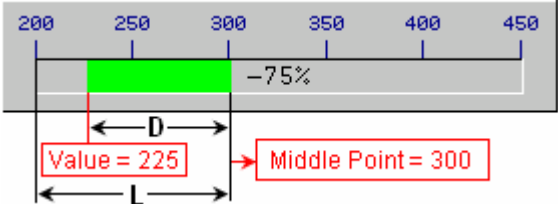
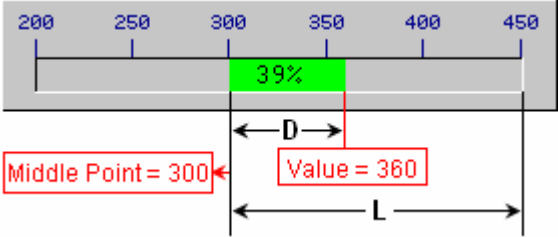
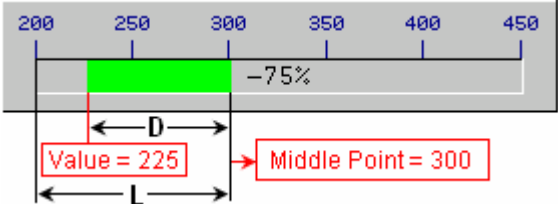
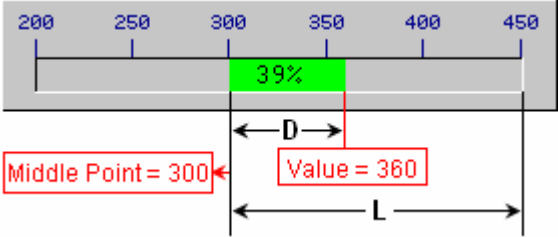
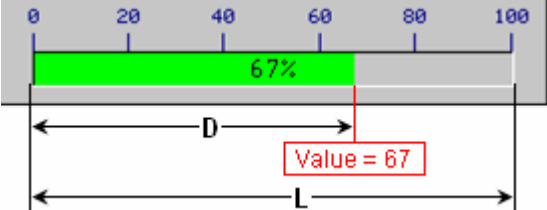
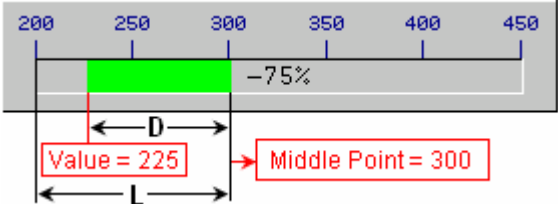
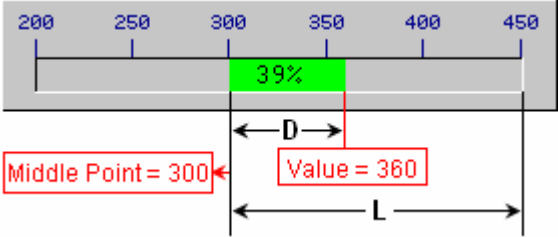
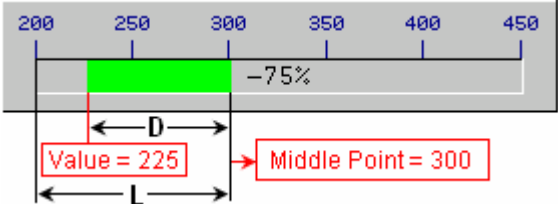
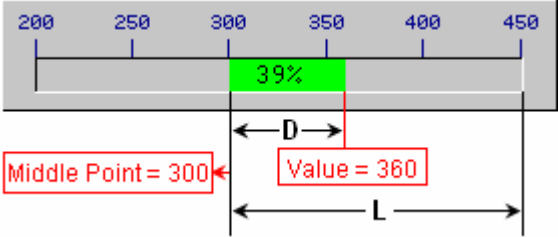
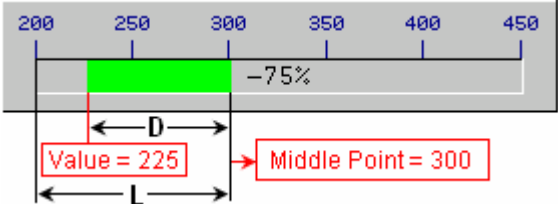
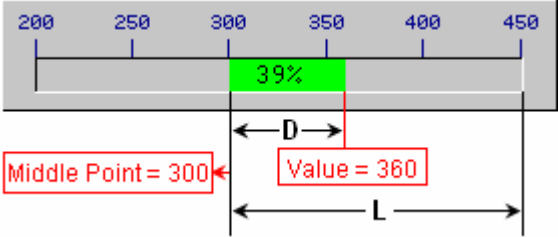
Options	Description																		
Percentage Display	A bar graph can show the current bar length as a percentage of the full bar length.																		
	<table border="1"> <thead> <tr> <th>Type</th> <th>Percentage</th> </tr> </thead> <tbody> <tr> <td data-bbox="256 271 454 577">Polar Bar</td> <td data-bbox="454 271 1520 577">  </td> </tr> <tr> <td data-bbox="256 577 454 835">Bipolar Bar</td> <td data-bbox="454 577 1520 835"> <table border="1"> <thead> <tr> <th>Value < Middle Point</th> <th>Percentage</th> </tr> </thead> <tbody> <tr> <td data-bbox="256 577 454 835">  </td> <td data-bbox="454 577 1520 835">- D / L x 100%</td> </tr> <tr> <td data-bbox="256 835 454 1126">Value > Middle Point</td> <td data-bbox="454 835 1520 1126">  </td> <td data-bbox="454 835 1520 1126">D / L x 100%</td> </tr> </tbody> </table> </td> </tr> <tr> <td colspan="2" data-bbox="256 1126 1520 1205">Select and set this option in the Advanced page.</td> </tr> <tr> <td data-bbox="76 1205 256 1276">Visibility Control</td> <td colspan="2" data-bbox="256 1205 1520 1276">A bar graph can be shown or hidden either by a specified bit or by the current user level. Select and set this option in the Visibility page.</td> </tr> </tbody> </table>	Type	Percentage	Polar Bar		Bipolar Bar	<table border="1"> <thead> <tr> <th>Value < Middle Point</th> <th>Percentage</th> </tr> </thead> <tbody> <tr> <td data-bbox="256 577 454 835">  </td> <td data-bbox="454 577 1520 835">- D / L x 100%</td> </tr> <tr> <td data-bbox="256 835 454 1126">Value > Middle Point</td> <td data-bbox="454 835 1520 1126">  </td> <td data-bbox="454 835 1520 1126">D / L x 100%</td> </tr> </tbody> </table>	Value < Middle Point	Percentage		- D / L x 100%	Value > Middle Point		D / L x 100%	Select and set this option in the Advanced page .		Visibility Control	A bar graph can be shown or hidden either by a specified bit or by the current user level. Select and set this option in the Visibility page .	
	Type	Percentage																	
Polar Bar																			
Bipolar Bar	<table border="1"> <thead> <tr> <th>Value < Middle Point</th> <th>Percentage</th> </tr> </thead> <tbody> <tr> <td data-bbox="256 577 454 835">  </td> <td data-bbox="454 577 1520 835">- D / L x 100%</td> </tr> <tr> <td data-bbox="256 835 454 1126">Value > Middle Point</td> <td data-bbox="454 835 1520 1126">  </td> <td data-bbox="454 835 1520 1126">D / L x 100%</td> </tr> </tbody> </table>	Value < Middle Point	Percentage		- D / L x 100%	Value > Middle Point		D / L x 100%											
Value < Middle Point	Percentage																		
	- D / L x 100%																		
Value > Middle Point		D / L x 100%																	
Select and set this option in the Advanced page .																			
Visibility Control	A bar graph can be shown or hidden either by a specified bit or by the current user level. Select and set this option in the Visibility page .																		

8.1.3. Settings

You can complete all the settings of a bar graph in the Bar Graph property sheet. This sheet contains the following six pages.

- **General**
Described in [Section 8.1.4](#).
- **Scale**
Described in [Section 4.4.4](#).
- **F. Marker**
Described in [Section 8.1.5](#).
- **B. Marker**
Described in [Section 8.1.5](#).
- **Advanced**
Described in [Section 8.1.6](#).
- **Visibility**
Described in [Section 4.4.6](#).

8.1.4. General Settings

This section describes how to define the general settings for a bar graph.

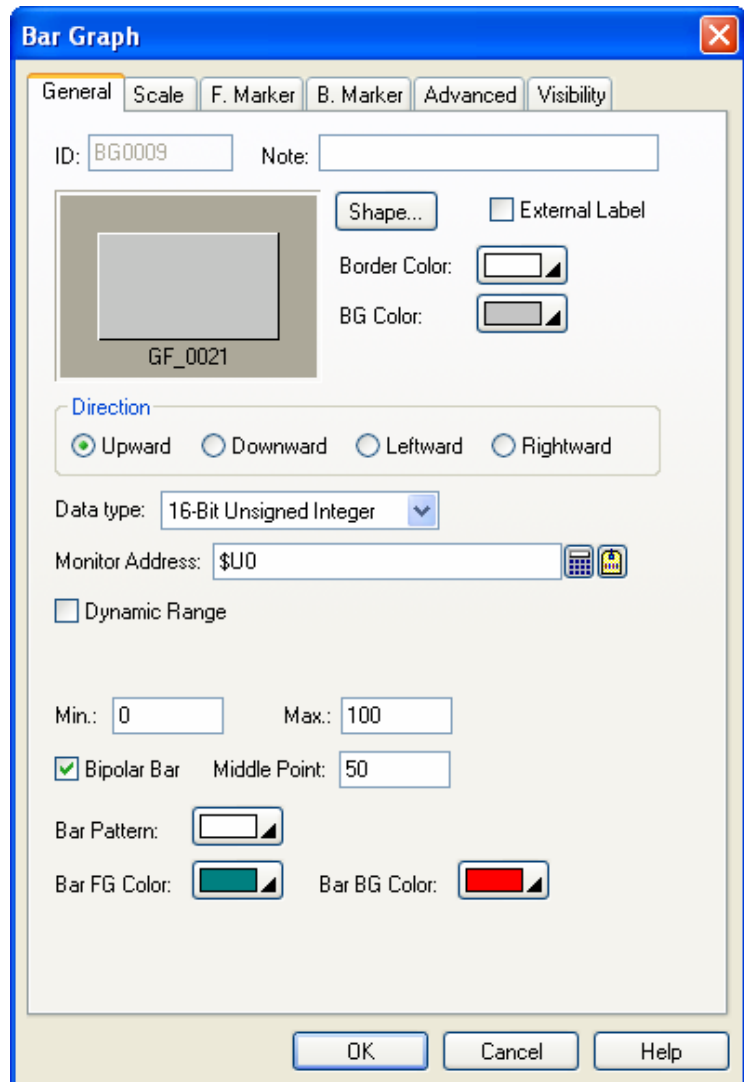
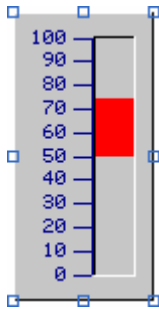





The above is an example of the General page of the Bar Graph dialog box.

The following table describes each property in the General page.

Property	Description
ID	The object's identifier. It is generated when the object is created. The identifier is unique within the screen where the object is located. The format of the IDs for the bar graphs is BGnnnn.
Note	You can type a note for the object.
Shape settings	For details about the following properties, see Section 4.3.1.4 Setting up the Shape of an Object , Shape... , Border Color, BG Color
External Label	Check this option if you want the object to have an external label. Set up the external label in the External Label page.
Direction	Specifies the bar direction for the bar graph.
Data Type	The data type of the monitored variable. The supported data types include: 16-Bit Unsigned Integer, 32-Bit Unsigned Integer, 16-Bit Signed Integer, 32-Bit Signed Integer, 16-Bit BCD, 32-Bit BCD, 32-Bit Floating Point, 16-Bit Signed BCD (LMB), 32-Bit Signed BCD (LMB), 16-Bit Signed BCD (LMD), and 32-Bit Signed BCD (LMD)

Continued

Property	Description																																
Monitor Address	Specifies the variable to be monitored. Click  to enter an address for this field. Click  to select a tag for this field.																																
Dynamic Range	Check this option so the minimum and maximum of the monitored variable will be specified at runtime. When this option is selected, the minimum and maximum of the marks for the scale of the bar graph can be specified at runtime as well. The data that specifies the above two ranges should be set and arranged correctly in a memory block called the dynamic range parameter block. You need to specify the dynamic range parameter block for the bar graph in the Dynamic Range Parameter Block field.																																
Dynamic Range Parameter Block	Specifies the variable that stores the dynamic range parameter block for the bar graph when Dynamic Range is selected. Click  to enter an address for this field. Click  to select a tag for this field. The following table shows the data arrangements of the parameter block when the data type is 16-bit and the scale of the bar graph is not dynamic. <table border="1" data-bbox="300 680 1214 813"> <thead> <tr> <th>Word</th> <th>Parameter</th> </tr> </thead> <tbody> <tr> <td>0</td> <td>The minimum of the monitored variable</td> </tr> <tr> <td>1</td> <td>The maximum of the monitored variable</td> </tr> </tbody> </table> The following table shows the data arrangement of the parameter block when the data type is 16-bit and the scale of the bar graph is dynamic. <table border="1" data-bbox="300 896 1214 1108"> <thead> <tr> <th>Word</th> <th>Parameter</th> </tr> </thead> <tbody> <tr> <td>0</td> <td>The minimum of the monitored variable</td> </tr> <tr> <td>1</td> <td>The maximum of the monitored variable</td> </tr> <tr> <td>2, 3</td> <td>The minimum of the mark for the scale; 32-bit integer number</td> </tr> <tr> <td>4, 5</td> <td>The maximum of the mark for the scale; 32-bit integer number</td> </tr> </tbody> </table> The following table shows the data arrangement of the parameter block when the data type is 32-bit and the scale of the bar graph is not dynamic. <table border="1" data-bbox="300 1191 1214 1319"> <thead> <tr> <th>Word</th> <th>Parameter</th> </tr> </thead> <tbody> <tr> <td>0, 1</td> <td>The minimum of the monitored variable</td> </tr> <tr> <td>2, 3</td> <td>The maximum of the monitored variable</td> </tr> </tbody> </table> The following table shows the data arrangement of the parameter block when the data type is 32-bit and the scale of the bar graph is dynamic. <table border="1" data-bbox="300 1402 1214 1615"> <thead> <tr> <th>Word</th> <th>Parameter</th> </tr> </thead> <tbody> <tr> <td>0, 1</td> <td>The minimum of the monitored variable</td> </tr> <tr> <td>2, 3</td> <td>The maximum of the monitored variable</td> </tr> <tr> <td>4, 5</td> <td>The minimum of the mark for the scale; 32-bit integer number</td> </tr> <tr> <td>6, 7</td> <td>The maximum of the mark for the scale; 32-bit integer number</td> </tr> </tbody> </table>	Word	Parameter	0	The minimum of the monitored variable	1	The maximum of the monitored variable	Word	Parameter	0	The minimum of the monitored variable	1	The maximum of the monitored variable	2, 3	The minimum of the mark for the scale; 32-bit integer number	4, 5	The maximum of the mark for the scale; 32-bit integer number	Word	Parameter	0, 1	The minimum of the monitored variable	2, 3	The maximum of the monitored variable	Word	Parameter	0, 1	The minimum of the monitored variable	2, 3	The maximum of the monitored variable	4, 5	The minimum of the mark for the scale; 32-bit integer number	6, 7	The maximum of the mark for the scale; 32-bit integer number
Word	Parameter																																
0	The minimum of the monitored variable																																
1	The maximum of the monitored variable																																
Word	Parameter																																
0	The minimum of the monitored variable																																
1	The maximum of the monitored variable																																
2, 3	The minimum of the mark for the scale; 32-bit integer number																																
4, 5	The maximum of the mark for the scale; 32-bit integer number																																
Word	Parameter																																
0, 1	The minimum of the monitored variable																																
2, 3	The maximum of the monitored variable																																
Word	Parameter																																
0, 1	The minimum of the monitored variable																																
2, 3	The maximum of the monitored variable																																
4, 5	The minimum of the mark for the scale; 32-bit integer number																																
6, 7	The maximum of the mark for the scale; 32-bit integer number																																
Min.	Specifies the minimum of the monitored variable when Dynamic Range is not selected.																																
Max.	Specifies the maximum of the monitored variable when Dynamic Range is not selected.																																
Bipolar Bar	Check this option for the bar graph to display the difference between the monitored value and the value specified in the Middle Point field.																																
Middle Point	Specifies the reference value/point for the bipolar bar.																																
Pie Pattern	Select a pattern for the bar graph. The pattern will be used to fill the bar. When the pattern is filled in the bar, the black part of the pattern is painted with the color specified in the Bar FG Color field, and the white part of the pattern is painted with the color specified in the Bar BG Color field.																																
Pie FG Color	Select a color for painting the black part of the specified pattern.																																
Pie BG Color	Select a color for painting the white part of the specified pattern.																																

8.1.5. Forward and Backward Marker Settings

This section describes how to define the forward marker and the backward marker settings for a bar graph. The following is an example of the Forward Marker page.

The following table describes each property in the Forward Marker page and the Backward Marker page.

Property	Description																								
Number of Marks	Specifies the maximum number of marks this marker can support.																								
Location	Select Up or Down for the location of the marker when the bar direction is Leftward or Rightward. Select Left or Right for the location of the marker when the bar direction is Upward or Downward.																								
Forward/Backward Marker Control Block	<p>Specifies the variable that stores the marker control block.</p> <p>Click to enter an address for this field. Click to select a tag for this field.</p> <p>The following table shows the data arrangement of the marker control block when the data type is 16-bit.</p> <table border="1"> <thead> <tr> <th>Word</th> <th>Description</th> </tr> </thead> <tbody> <tr> <td>0</td> <td>Specifies the actual number of marks that the marker will display.</td> </tr> <tr> <td>1</td> <td>The value of mark 1.</td> </tr> <tr> <td>2</td> <td>The value of mark 2</td> </tr> <tr> <td>...</td> <td>...</td> </tr> <tr> <td>12</td> <td>The value of mark 12</td> </tr> </tbody> </table> <p>The following table shows the data arrangement of the marker control block when the data type is 32-bit.</p> <table border="1"> <thead> <tr> <th>Word</th> <th>Description</th> </tr> </thead> <tbody> <tr> <td>0,1</td> <td>Specifies the actual number of marks that the marker will display.</td> </tr> <tr> <td>2,3</td> <td>The value of mark 1.</td> </tr> <tr> <td>4,5</td> <td>The value of mark 2</td> </tr> <tr> <td>...</td> <td>...</td> </tr> <tr> <td>24,25</td> <td>The value of mark 12</td> </tr> </tbody> </table> <p>Note: The data format of the mark values should be the same as that of the monitored variable.</p>	Word	Description	0	Specifies the actual number of marks that the marker will display.	1	The value of mark 1.	2	The value of mark 2	12	The value of mark 12	Word	Description	0,1	Specifies the actual number of marks that the marker will display.	2,3	The value of mark 1.	4,5	The value of mark 2	24,25	The value of mark 12
Word	Description																								
0	Specifies the actual number of marks that the marker will display.																								
1	The value of mark 1.																								
2	The value of mark 2																								
...	...																								
12	The value of mark 12																								
Word	Description																								
0,1	Specifies the actual number of marks that the marker will display.																								
2,3	The value of mark 1.																								
4,5	The value of mark 2																								
...	...																								
24,25	The value of mark 12																								

Continued

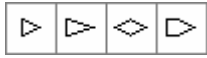
Property		Description
Mark No. 1 - No. 12	Style	Specifies the mark style. There are four mark styles: 
	Border Color	The border color of the mark.
	LT Color	The fill color of the mark when the monitored value is less than the mark's value.
	EQ Color	The fill color of the mark when the monitored value is equal to the mark's value.
	GT Color	The fill color of the mark when the monitored value is greater than the mark's value.

8.1.6. Advanced Settings

This section describes how to define the advanced settings for the bar graphs and circular bar graphs with the Advanced page. The following is an example of the Advanced page.









The following table describes each property in the Advanced page.

Property		Description	
Range Display	Range Display	Check this option if you want the object to display the monitored value with different colors when the monitored value is below the specified low limit or above the specified high limit.	
	Variable Range	Check this option if the low limit and high limit are specified at runtime by the designated variables.	
	Low Limit	Specifies the low limit when Variable Range is not selected. When Variable Range is selected, this property specifies the variable whose value is the low limit. Click to enter an address. Click to select a tag.	
	High Limit	Specifies the high limit when Variable Range is not selected. When Variable Range is selected, this property specifies the variable whose value is the high limit. Click to enter an address. Click to select a tag.	
	High Color	FG Color	The bar FG color for the high limit.
		BG Color	The bar BG color for the high limit.
	Low Color	FG Color	The bar FG color for the low limit.
BG Color		The bar BG color for the low limit.	
Percentage Display	Percentage Display	Check this option so the object will display the percentage that is calculated by the following formula: $\text{Percentage} = (\text{Value} - \text{Min.}) / (\text{Max.} - \text{Min.}) * 100\%$ <p>If the bipolar bar is used, the percentage formula when Value > Middle Point is: $\text{Percentage} = (\text{Value} - \text{Middle Point}) / (\text{Max.} - \text{Middle Point}) * 100\%$ The percentage formula when Value < Middle Point is: $\text{Percentage} = -(\text{Middle Point} - \text{Value}) / (\text{Middle Point} - \text{Min.}) * 100\%$ <p>The <i>Value</i> is the current value of the monitored variable. The <i>Max.</i> and <i>Min.</i> define the value range of the monitored variable and are defined in the General page of the property sheet.</p> </p>	
	Text Color	Select a color for the percentage display.	
	Font	Select a fixed size font for the percentage display.	

8.2. Meters

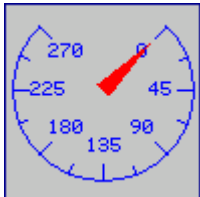
8.2.1. Basic Operations

A meter shows the value of a monitored variable by rotating its needle to the appropriate place. When the value of the variable increases or decreases, the rotation angle of the needle increases or decreases accordingly. A meter can have an arc/circle scale that enables you to measure the rotation angle of the needle and read the current value for the monitored variable. A meter can be configured to perform one of the following swing types:

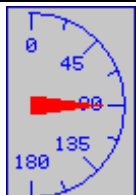
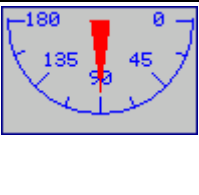
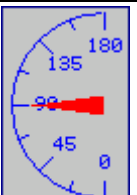
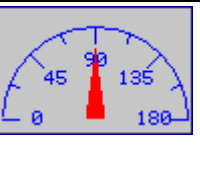
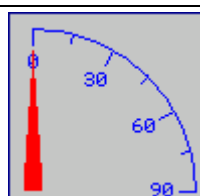
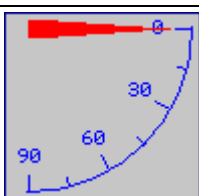
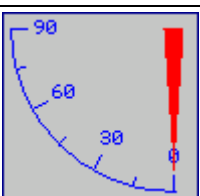
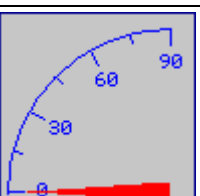
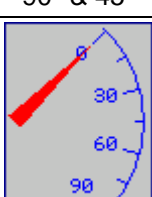
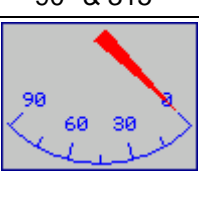
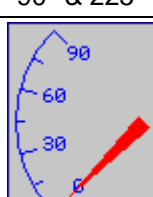
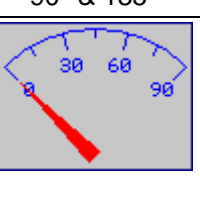
Span and Origin	360° & 90°	360° & 0°	360° & 270°	360° & 180°
Example				
Span and Origin	270° & 45°	270° & 315°	270° & 225°	270° & 135°
Example				
Span and Origin	180° & 90°	180° & 0°	180° & 270°	180° & 180°
Example				
Span and Origin	90° & 90°	90° & 0°	90° & 270°	90° & 180°
Example				
Span and Origin	90° & 45°	90° & 315°	90° & 225°	90° & 135°
Example				

8.2.2. Operation Options

The following operation options can be added to a meter to make it more informative. You need to select and set these options in the Meter property sheet.

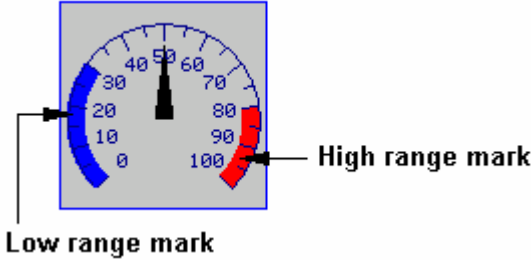
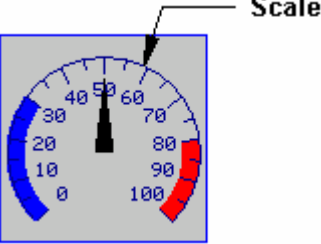
Options	Description
Range Display	 <p>The meter can display the low range mark and the high range mark along its swing path. The limits for range marks can be specified at runtime by the designated variables. Select and set this option in the Range page.</p>
Scale	 <p>The meter can have a scale. Select and set this option in the Scale page.</p>
Visibility Control	<p>The meter can be shown or hidden either by a specified bit or by the current user level. Select and set this option in the Visibility page.</p>

8.2.3. Settings

You can complete all the settings of a meter in the Meter property sheet. This sheet contains the following four pages.

- **General**

Described in [Section 8.2.4.](#)

- **Range**

Described in [Section 8.2.5.](#)

- **Scale**

Described in [Section 4.4.4.](#)

- **Visibility**

Described in [Section 4.4.6.](#)

8.2.4. General Settings

This section describes how to define the general settings for a meter.

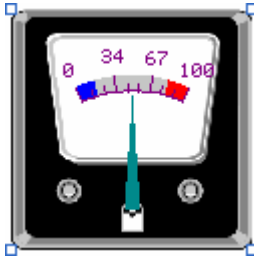

Meter
✕

General
Range
Scale
Visibility

ID:

Note:

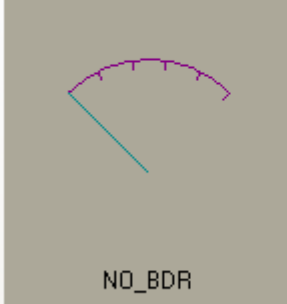

NO_BDR

Picture Shape

MeterPanel ▼

Shape... Swing...

Border Color:

BG Color:

Direction: Clockwise

Data Type:

Monitor Address:

Dynamic Range

Min.:

Max.:

Needle Color:

Swing Adjustment

Radius: ▲▼





Angle: ▲▼

Center X: ▲▼

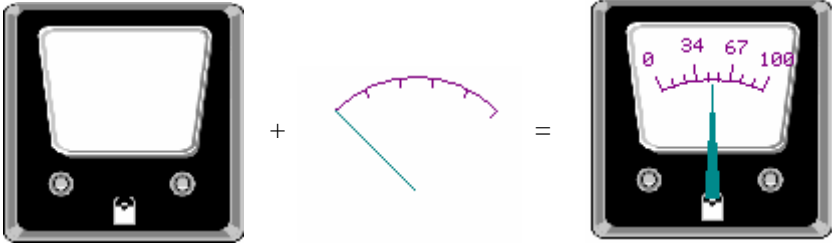

Center Y: ▲▼

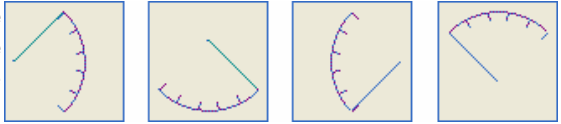
The above is an example of the General page of the Meter property sheet.

The following table describes each property in the General page.

Property		Description
ID		The object's identifier. It is generated when the object is created. The identifier is unique within the screen where the object is located. The format of the IDs for the meters is Mnnnn.
Note		You can type a note for the object.
Picture Shape	Picture Shape	<p>Check this option if you want to use a picture for the meter's shape. You can use a picture to customize your own meter. For example:</p>  <p>Note: If Picture Shape is checked, Shape..., Border Color and BG Color fields are not available to be used.</p>
	<Drop-down List>	The name of the picture. You can use the drop-down list to select a picture from the picture database.
		Click this icon to select a picture file. After selection, the picture of the selected file is imported and saved in the picture database.
		Click this icon to bring up the Select/Import from Library dialog box. Select a picture from a picture library file. After selection, the selected picture is imported and saved in the picture database.
Graphical shape settings		For details about the following properties, Section 4.3.1.4 Setting up the Shape of an Object , <input type="text" value="Shape..."/> , Border Color, BG Color
Swing		<p>Specifies the type of swing. For details, see Section 8.2.1 Basic Operation.</p> <p>The swing styles on the right are more space saving because their needles can be placed outside the shape by changing the position of Center X or Center Y.</p> 
Direction		Specifies the direction that the needle moves. Only Clockwise is available.
Data Type		The data type of the monitored variable. The supported data types include: 16-Bit Unsigned Integer, 32-Bit Unsigned Integer, 16-Bit Signed Integer, 32-Bit Signed Integer, 16-Bit BCD, 32-Bit BCD, 32-Bit Floating Point, 16-Bit Signed BCD (LMB), 32-Bit Signed BCD (LMB), 16-Bit Signed BCD (LMD), and 32-Bit Signed BCD (LMD).
Monitor Address		<p>Specifies the variable to be monitored.</p> <p>Click  to enter an address for this field. Click  to select a tag for this field.</p>







Continued

Property		Description																															
Dynamic Range	Dynamic Range	Check this option so the minimum and maximum of the monitored variable will be specified at runtime. When this option is selected, the minimum and maximum of the marks for the scale of the meter can be specified at runtime as well. The data that specifies the above two ranges should be set and arranged correctly in a memory block called the dynamic range parameter block. You need to specify the dynamic range parameter block for the meter in the Dynamic Range Parameter Block field.																															
	Dynamic Range Parameter Block	<p>Specifies the variable that stores the dynamic range parameter block for the meter when Dynamic Range is selected. Click  to enter an address for this field. Click  to select a tag for this field.</p> <p>The following table shows the content of the parameter block when the data type is 16-bit and the scale of the meter is not dynamic.</p> <table border="1"> <thead> <tr> <th>Word</th> <th>Parameter</th> </tr> </thead> <tbody> <tr> <td>0</td> <td>The minimum of the monitored variable</td> </tr> <tr> <td>1</td> <td>The maximum of the monitored variable</td> </tr> </tbody> </table> <p>The following table shows the content of the parameter block when the data type is 16-bit and the scale of the meter is dynamic.</p> <table border="1"> <thead> <tr> <th>Word</th> <th>Parameter</th> </tr> </thead> <tbody> <tr> <td>0</td> <td>The minimum of the monitored variable</td> </tr> <tr> <td>1</td> <td>The maximum of the monitored variable</td> </tr> <tr> <td>2, 3</td> <td>The minimum of the mark for the scale; 32-bit integer number</td> </tr> <tr> <td>4, 5</td> <td>The maximum of the mark for the scale; 32-bit integer number</td> </tr> </tbody> </table> <p>The following table shows the content of the parameter block when the data type is 32-bit and the scale of the meter is not dynamic.</p> <table border="1"> <thead> <tr> <th>Word</th> <th>Parameter</th> </tr> </thead> <tbody> <tr> <td>0, 1</td> <td>The minimum of the monitored variable</td> </tr> <tr> <td>2, 3</td> <td>The maximum of the monitored variable</td> </tr> </tbody> </table> <p>The following table shows the content of the parameter block when the data type is 32-bit and the scale of the meter is dynamic.</p> <table border="1"> <thead> <tr> <th>Word</th> <th>Parameter</th> </tr> </thead> <tbody> <tr> <td>0, 1</td> <td>The minimum of the monitored variable</td> </tr> <tr> <td>2, 3</td> <td>The maximum of the monitored variable</td> </tr> <tr> <td>4, 5</td> <td>The minimum of the mark for the scale; 32-bit integer number</td> </tr> <tr> <td>6, 7</td> <td>The maximum of the mark for the scale; 32-bit integer number</td> </tr> </tbody> </table>	Word	Parameter	0	The minimum of the monitored variable	1	The maximum of the monitored variable	Word	Parameter	0	The minimum of the monitored variable	1	The maximum of the monitored variable	2, 3	The minimum of the mark for the scale; 32-bit integer number	4, 5	The maximum of the mark for the scale; 32-bit integer number	Word	Parameter	0, 1	The minimum of the monitored variable	2, 3	The maximum of the monitored variable	Word	Parameter	0, 1	The minimum of the monitored variable	2, 3	The maximum of the monitored variable	4, 5	The minimum of the mark for the scale; 32-bit integer number	6, 7
Word	Parameter																																
0	The minimum of the monitored variable																																
1	The maximum of the monitored variable																																
Word	Parameter																																
0	The minimum of the monitored variable																																
1	The maximum of the monitored variable																																
2, 3	The minimum of the mark for the scale; 32-bit integer number																																
4, 5	The maximum of the mark for the scale; 32-bit integer number																																
Word	Parameter																																
0, 1	The minimum of the monitored variable																																
2, 3	The maximum of the monitored variable																																
Word	Parameter																																
0, 1	The minimum of the monitored variable																																
2, 3	The maximum of the monitored variable																																
4, 5	The minimum of the mark for the scale; 32-bit integer number																																
6, 7	The maximum of the mark for the scale; 32-bit integer number																																
Min.		Specifies the minimum of the monitored variable when Dynamic Range is not selected.																															
Max.		Specifies the maximum of the monitored variable when Dynamic Range is not selected.																															
Needle Color		Select a color for the needle.																															
Swing Adjustment	Radius	You can adjust the radius of the swing of the needle. This field specifies the offset to be added to the default radius.																															
	Angle	You can adjust the span of the swing of the needle. This field specifies the offset to be added to the default span.																															
	Center X	You can adjust the horizontal position for the pivot of the needle. This field specifies the offset to be added to the default horizontal position.																															
	Center Y	You can adjust the vertical position for the pivot of the needle. This field specifies the offset to be added to the default vertical position.																															





8.2.5. Range Settings

This section describes how to define the range settings for a meter. The following is an example of the Range page of the Meter property sheet.

The screenshot shows the 'Range' tab of a property sheet. It contains the following settings:

- Range Display
- Variable Range
- Low Limit:  
- High Limit:  
- Low Color: 
- High Color: 

The following table describes each property in the Range page.

Property	Description
Range Display	Check this option if you want the meter to display the range marks along its swing path.
Variable Range	Check this option so the low limit and high limit for the range marks will be specified at runtime by the designated variables.
Low Limit	Specifies the low limit of the low range mark when Variable Range is not selected. When Variable Range is selected, this property specifies the variable whose value is the low limit of the low range mark at runtime. Click  to enter an address for this field. Click  to select a tag for this field.
High Limit	Specifies the high limit of the high range mark when Variable Range is not selected. When Variable Range is selected, this property specifies the variable whose value is the high limit of the high range mark at runtime. Click  to enter an address for this field. Click  to select a tag for this field.
Low Color	The color of the low range mark.
High Color	The color of the high range mark.

8.3. Circular Bar Graphs

8.3.1. Basic Operations

A circular bar graph shows the value of a monitored variable by displaying a circular bar with variable length. When the value of the variable increases or decreases, the length of the circular bar increases or decreases accordingly. A circular bar graph can have a circular scale and the scale enables you to measure the length of the bar and read the current value of the monitored variable. The following table lists the supported styles of circular bar graphs.

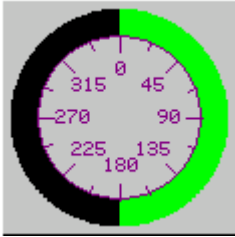
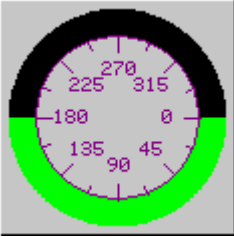
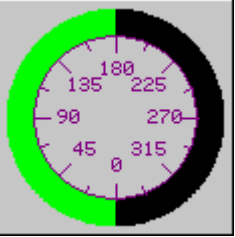
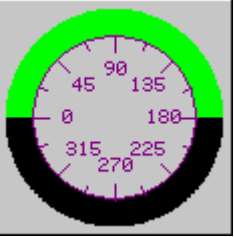
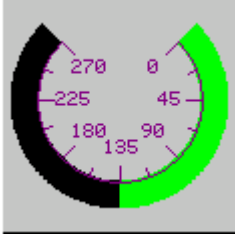
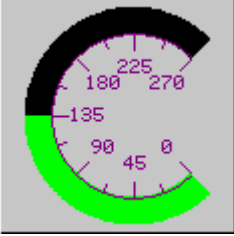
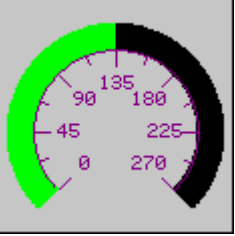
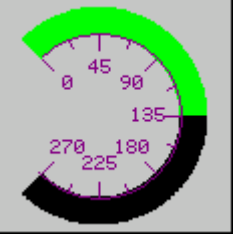
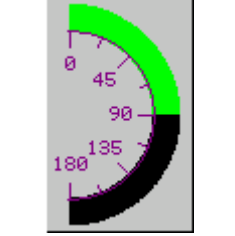
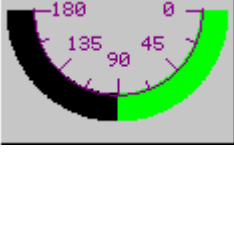
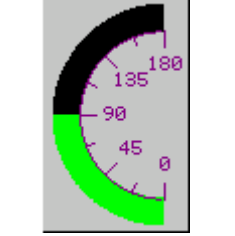
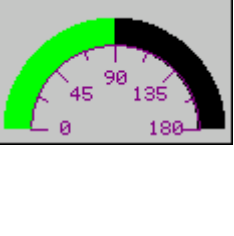
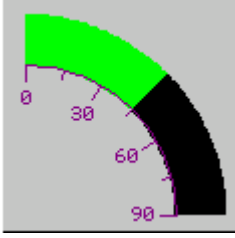
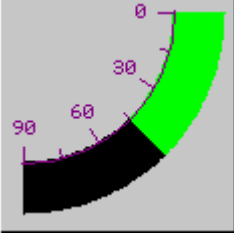
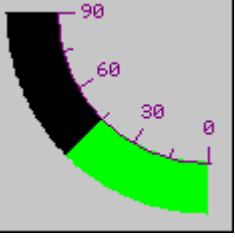
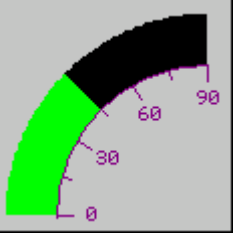
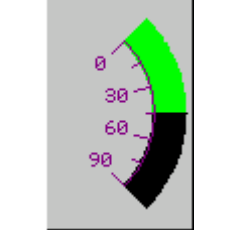
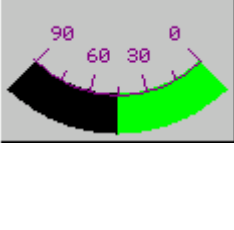
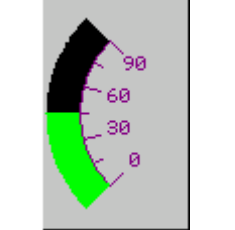
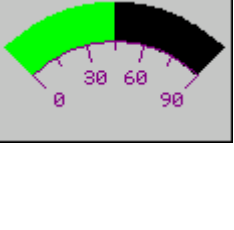
Span and Origin	360° & 90°	360° & 0°	360° & 270°	360° & 180°
Example				
Span and Origin	270° & 45°	270° & 315°	270° & 225°	270° & 135°
Example				
Span and Origin	180° & 90°	180° & 0°	180° & 270°	180° & 180°
Example				
Span and Origin	90° & 90°	90° & 0°	90° & 270°	90° & 180°
Example				
Span and Origin	90° & 45°	90° & 315°	90° & 225°	90° & 135°
Example				

8.3.2. Operation Options

The following operation options can be added to a circular bar graph to make it more informative. You need to select and set up these options in the Circular Bar Graph property sheet.

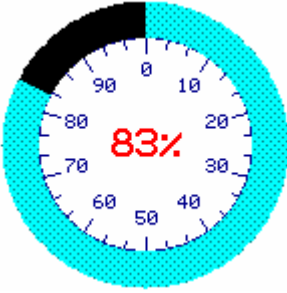
Options	Description
Range Display	You can specify a low limit and a high limit for the object. The limits can be constants or variables. At runtime, when the monitored value is below the low limit, the object shows the bar with the FG color and the BG color set for the low limit. When the monitored value is above the high limit, the object shows the bar with the FG color and the BG color set for the high limit.
Percentage Display	The object can show the current bar length as a percentage of the full bar length.  <p>Select and set up this option in the Advanced page.</p>
Scale	The circular bar graph can have a circular scale. Select and set up this option in the Scale page.
Visibility Control	The object can be shown or hidden either by a specified bit or by the current user level. Select and set up this option in the Visibility page.

8.3.3. Settings

You can complete all the settings of a circular bar graph in the Circular Bar Graph property sheet. This sheet contains the following four pages.

- **General**
Described in [Section 8.3.4.](#)
- **Scale**
Described in [Section 4.4.4.](#)
- **Advanced**
Described in [Section 4.4.5.](#)
- **Visibility**
Described in [Section 4.4.6.](#)

8.3.4. General Settings

This section describes how to define the general settings for a circular bar graph.

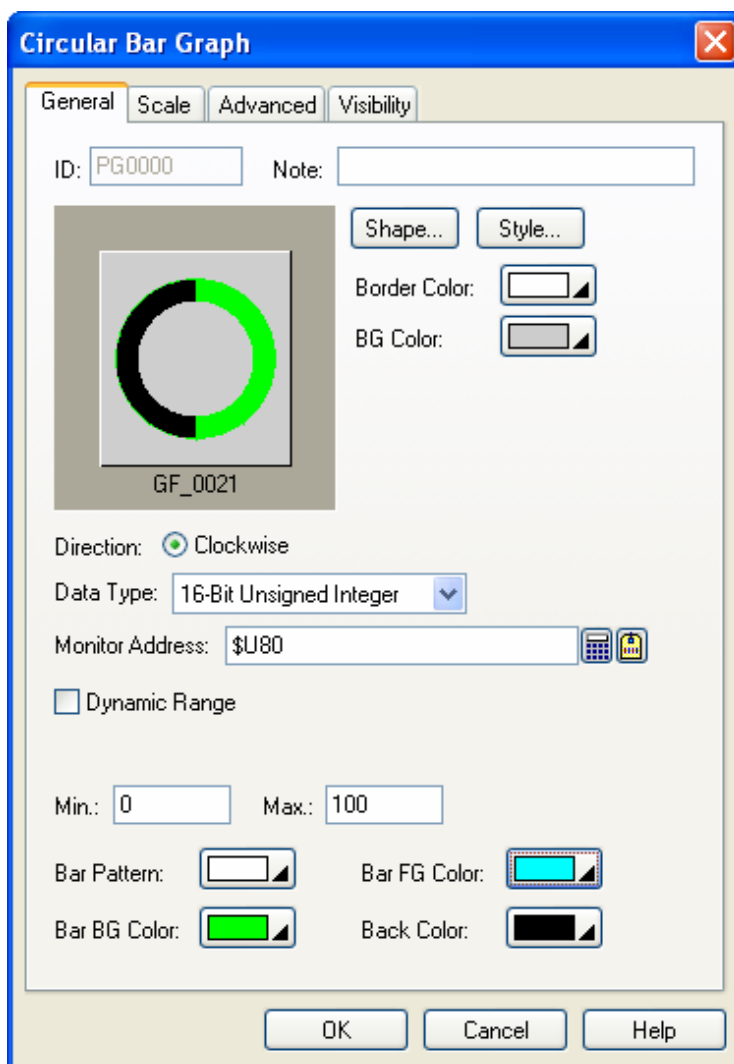





The above is an example of the General page of the Circular Bar Graph property sheet.

The following table describes each property in the General page.

Property	Description
ID	The object's identifier. It is generated when the object is created. The identifier is unique within the screen where the object is located. The format of the IDs for the circular bar graphs is PGnnnn.
Note	You can type a note for the object.
Shape settings	For details about the following properties, Section 4.3.1.4 Setting up the Shape of an Object. Shape... , Border Color, BG Color
Style	Specifies the style of the circular bar graph. For details, see Section 8.3.1 Basic Operations.
Direction	Specifies the progress direction of the circular bar graph. Only Clockwise is available.
Data Type	The data type of the monitored variable. The supported data types include: 16-Bit Unsigned Integer, 32-Bit Unsigned Integer, 16-Bit Signed Integer, 32-Bit Signed Integer, 16-Bit BCD, 32-Bit BCD, and 32-Bit Floating Point.

Continued

Property	Description																																
Monitor Address	Specifies the variable to be monitored. Click  to enter an address for this field. Click  to select a tag for this field.																																
Dynamic Range	Check this option so the minimum and maximum of the monitored variable will be specified at runtime. When this option is selected, the minimum and maximum of the marks of the scale of the circular bar graph can be specified at runtime as well. The data that specifies the above two ranges should be set and arranged correctly in a memory block called the dynamic range parameter block. You need to specify the dynamic range parameter block for the circular bar graph in the Dynamic Range Parameter Block field.																																
Dynamic Range Parameter Block	Specifies the variable that stores the dynamic range parameter block for the circular bar graph when Dynamic Range is selected. Click  to enter an address for this field. Click  to select a tag for this field. The following table shows the content of the parameter block when the data type is 16-bit and the scale of the circular bar graph is not dynamic. <table border="1" data-bbox="288 707 1198 835"> <thead> <tr> <th>Word</th> <th>Parameter</th> </tr> </thead> <tbody> <tr> <td>0</td> <td>The minimum of the monitored variable</td> </tr> <tr> <td>1</td> <td>The maximum of the monitored variable</td> </tr> </tbody> </table> The following table shows the content of the parameter block when the data type is 16-bit and the scale of the circular bar graph is dynamic. <table border="1" data-bbox="288 947 1198 1158"> <thead> <tr> <th>Word</th> <th>Parameter</th> </tr> </thead> <tbody> <tr> <td>0</td> <td>The minimum of the monitored variable</td> </tr> <tr> <td>1</td> <td>The maximum of the monitored variable</td> </tr> <tr> <td>2, 3</td> <td>The minimum of the mark for the scale; 32-bit integer number</td> </tr> <tr> <td>4, 5</td> <td>The maximum of the mark for the scale; 32-bit integer number</td> </tr> </tbody> </table> The following table shows the content of the parameter block when the data type is 32-bit and the scale of the circular bar graph is not dynamic. <table border="1" data-bbox="288 1267 1198 1395"> <thead> <tr> <th>Word</th> <th>Parameter</th> </tr> </thead> <tbody> <tr> <td>0, 1</td> <td>The minimum of the monitored variable</td> </tr> <tr> <td>2, 3</td> <td>The maximum of the monitored variable</td> </tr> </tbody> </table> The following table shows the content of the parameter block when the data type is 32-bit and the scale of the circular bar graph is dynamic. <table border="1" data-bbox="288 1505 1198 1715"> <thead> <tr> <th>Word</th> <th>Parameter</th> </tr> </thead> <tbody> <tr> <td>0, 1</td> <td>The minimum of the monitored variable</td> </tr> <tr> <td>2, 3</td> <td>The maximum of the monitored variable</td> </tr> <tr> <td>4, 5</td> <td>The minimum of the mark for the scale; 32-bit integer number</td> </tr> <tr> <td>6, 7</td> <td>The maximum of the mark for the scale; 32-bit integer number</td> </tr> </tbody> </table>	Word	Parameter	0	The minimum of the monitored variable	1	The maximum of the monitored variable	Word	Parameter	0	The minimum of the monitored variable	1	The maximum of the monitored variable	2, 3	The minimum of the mark for the scale; 32-bit integer number	4, 5	The maximum of the mark for the scale; 32-bit integer number	Word	Parameter	0, 1	The minimum of the monitored variable	2, 3	The maximum of the monitored variable	Word	Parameter	0, 1	The minimum of the monitored variable	2, 3	The maximum of the monitored variable	4, 5	The minimum of the mark for the scale; 32-bit integer number	6, 7	The maximum of the mark for the scale; 32-bit integer number
Word	Parameter																																
0	The minimum of the monitored variable																																
1	The maximum of the monitored variable																																
Word	Parameter																																
0	The minimum of the monitored variable																																
1	The maximum of the monitored variable																																
2, 3	The minimum of the mark for the scale; 32-bit integer number																																
4, 5	The maximum of the mark for the scale; 32-bit integer number																																
Word	Parameter																																
0, 1	The minimum of the monitored variable																																
2, 3	The maximum of the monitored variable																																
Word	Parameter																																
0, 1	The minimum of the monitored variable																																
2, 3	The maximum of the monitored variable																																
4, 5	The minimum of the mark for the scale; 32-bit integer number																																
6, 7	The maximum of the mark for the scale; 32-bit integer number																																
Min.	Specifies the minimum of the monitored variable when Dynamic Range is not selected.																																
Max.	Specifies the maximum of the monitored variable when Dynamic Range is not selected.																																
Bar Pattern	Select a pattern for the circular bar graph. The pattern will be used to fill the arc/circular strip of the circular bar graph. When the pattern fills in the circular bar graph, the black part of the pattern is painted with the color specified in the Bar FG Color field, and the white part of the pattern is painted with the color specified in the Bar BG Color field.																																
Bar FG Color	Select a color for painting the black part of the specified pattern.																																
Bar BG Color	Select a color for painting the white part of the specified pattern.																																
Back Color	Select a color as the background color for the arc/circular strip of the circular bar graph.																																

8.4. Line Charts

8.4.1. Basic Operations

A line chart displays a set of data by drawing a data point for each datum and drawing a line that connects all the data points in sequence. The vertical position of a data point is determined by the value of the associated datum. The horizontal position of a data point is determined by the order of the associated datum in the data set.

Number of data points	5
Data point 0	40
Data point 1	60
Data point 2	50
Data point 3	35
Data point 4	70

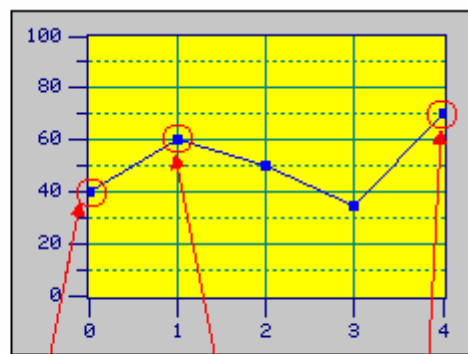

Data point Data point Data point

A line chart can display up to 8 sets of data. The following example shows a line chart that displays 3 sets of data.

Number of data points	5		
Data set	1	2	3
Data point 0	40	20	70
Data point 1	60	25	80
Data point 2	50	40	60
Data point 3	35	60	70
Data point 4	70	90	80

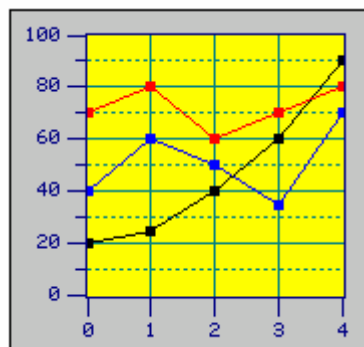

A line chart can provide a cursor for you to select desired data points. The cursor of the line chart is a vertical line segment. The user can move the cursor horizontally within a line chart to the desired data point(s). The values of the selected data points can be displayed and output to an internal variable called Cursor Data Receiving Buffer.

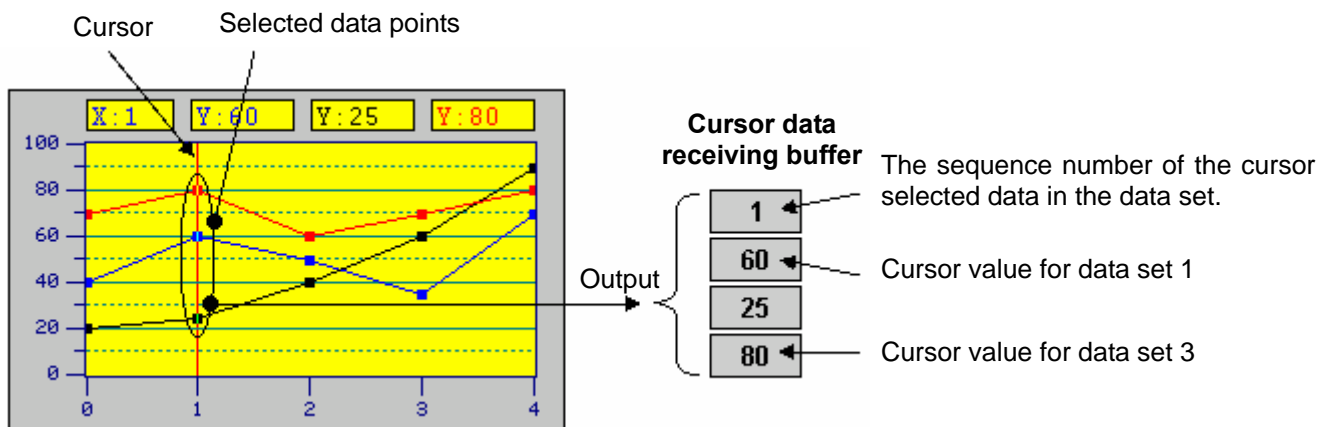

8.4.2. Operation Options

The following operation option can be added to a line chart. Select and set the option in the Line Chart dialog box.

Options	Description
Visibility Control	You can show and hide a line chart by a specified bit or the current user level. Select and set this option in the Visibility page.

8.4.3. Settings

You can complete all the settings of a line chart in the Line Chart dialog box. This dialog box contains the following four pages.

- **General**

Described in [Section 8.4.4.](#)

- **Pen**

Described in [Section 8.4.5.](#)

- **XY Axis**

Described in [Section 8.4.6.](#)

- **Visibility**

Described in [Section 4.4.6.](#)

8.4.4. General Settings



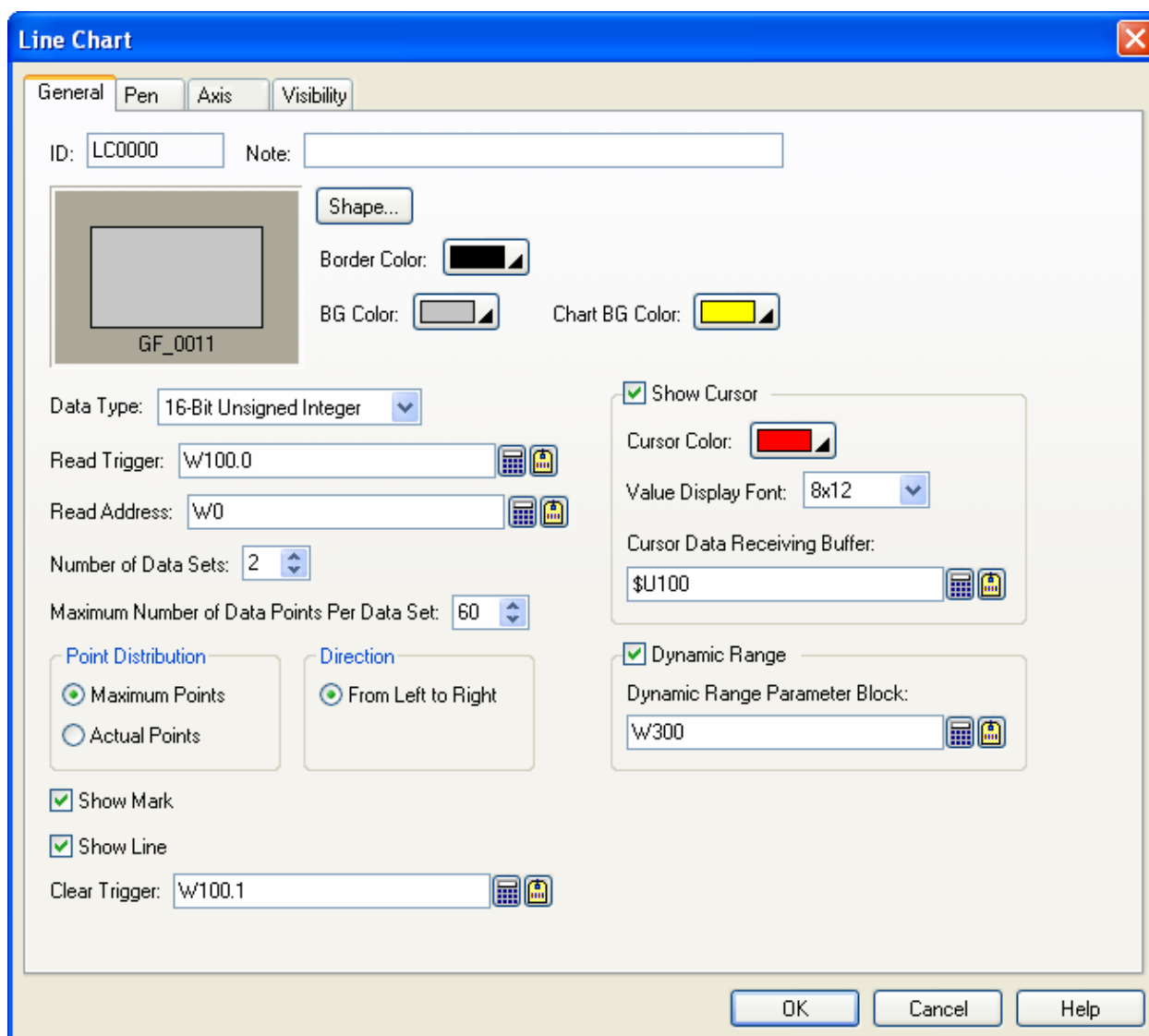

This section describes how to define the general settings for a line chart. The following is an example of the General page of the Line Chart property sheet.



The following table describes each property in the General page.

Property	Description
ID	The object's identifier. It is generated when the object is created. The identifier is unique within the screen where the object is located. The format of the IDs for the line charts is LCnnnn.
Note	You can type a note for the object.
Shape settings	For details about the following properties, see Section 4.3.1.4 Setting up the Shape of an Object . Shape... , Border Color, BG Color
Chart BG Color	Select a color for the background of the chart.
Data Type	The type of the data that the line chart will display. The supported data types include: 16-Bit Unsigned Integer, 32-Bit Unsigned Integer, 16-Bit Signed Integer, 32-Bit Signed Integer, 16-Bit BCD, 32-Bit BCD, 32-Bit Floating Point, 16-Bit Signed BCD (LMB), 32-Bit Signed BCD (LMB), 16-Bit Signed BCD (LMD), and 32-Bit Signed BCD (LMD).





Continued

Property	Description																																																												
Read Trigger	The bit variable that will trigger the line chart to read and display data. The bit variable triggers the line chart when its state changes from off to on. Click  to enter an address for this field. Click  to select a tag for this field.																																																												
Read Address	<p>The variable whose data is to be read and displayed. Click  to enter an address for this field. Click  to select a tag for this field.</p> <p>The following tables show the data arrangements of the variable.</p> <p>Data Type: 16-bit; Number of Data Sets: 1</p> <table border="1" data-bbox="395 577 917 831"> <thead> <tr> <th>Word</th> <th>Description</th> </tr> </thead> <tbody> <tr> <td>0</td> <td>Actual number of data points</td> </tr> <tr> <td>1</td> <td>Data point 0</td> </tr> <tr> <td>2</td> <td>Data point 1</td> </tr> <tr> <td>...</td> <td>...</td> </tr> <tr> <td>n+1</td> <td>Data point n</td> </tr> </tbody> </table> <p>Data Type: 16-bit; Number of Data Sets: 2</p> <table border="1" data-bbox="395 913 917 1294"> <thead> <tr> <th>Word</th> <th>Description</th> </tr> </thead> <tbody> <tr> <td>0</td> <td>Actual number of data points</td> </tr> <tr> <td>1</td> <td>Data point 0; Data set 1</td> </tr> <tr> <td>2</td> <td>Data point 0; Data set 2</td> </tr> <tr> <td>3</td> <td>Data point 1; Data set 1</td> </tr> <tr> <td>4</td> <td>Data point 1; Data set 2</td> </tr> <tr> <td>...</td> <td>...</td> </tr> <tr> <td>2n+1</td> <td>Data point n; Data set 1</td> </tr> <tr> <td>2n+2</td> <td>Data point n; Data set 2</td> </tr> </tbody> </table> <p>Data Type: 16-bit; Number of Data Sets: 8</p> <table border="1" data-bbox="395 1377 917 2011"> <thead> <tr> <th>Word</th> <th>Description</th> </tr> </thead> <tbody> <tr> <td>0</td> <td>Actual number of data points</td> </tr> <tr> <td>1</td> <td>Data point 0; Data set 1</td> </tr> <tr> <td>2</td> <td>Data point 0; Data set 2</td> </tr> <tr> <td>3</td> <td>Data point 0; Data set 3</td> </tr> <tr> <td>4</td> <td>Data point 0; Data set 4</td> </tr> <tr> <td>5</td> <td>Data point 0; Data set 5</td> </tr> <tr> <td>6</td> <td>Data point 0; Data set 6</td> </tr> <tr> <td>7</td> <td>Data point 0; Data set 7</td> </tr> <tr> <td>8</td> <td>Data point 0; Data set 8</td> </tr> <tr> <td>9</td> <td>Data point 1; Data set 1</td> </tr> <tr> <td>10</td> <td>Data point 1; Data set 2</td> </tr> <tr> <td>...</td> <td>...</td> </tr> <tr> <td>8n+7</td> <td>Data point n; Data set 7</td> </tr> <tr> <td>8n+8</td> <td>Data point n; Data set 8</td> </tr> </tbody> </table>	Word	Description	0	Actual number of data points	1	Data point 0	2	Data point 1	n+1	Data point n	Word	Description	0	Actual number of data points	1	Data point 0; Data set 1	2	Data point 0; Data set 2	3	Data point 1; Data set 1	4	Data point 1; Data set 2	2n+1	Data point n; Data set 1	2n+2	Data point n; Data set 2	Word	Description	0	Actual number of data points	1	Data point 0; Data set 1	2	Data point 0; Data set 2	3	Data point 0; Data set 3	4	Data point 0; Data set 4	5	Data point 0; Data set 5	6	Data point 0; Data set 6	7	Data point 0; Data set 7	8	Data point 0; Data set 8	9	Data point 1; Data set 1	10	Data point 1; Data set 2	8n+7	Data point n; Data set 7	8n+8	Data point n; Data set 8
Word	Description																																																												
0	Actual number of data points																																																												
1	Data point 0																																																												
2	Data point 1																																																												
...	...																																																												
n+1	Data point n																																																												
Word	Description																																																												
0	Actual number of data points																																																												
1	Data point 0; Data set 1																																																												
2	Data point 0; Data set 2																																																												
3	Data point 1; Data set 1																																																												
4	Data point 1; Data set 2																																																												
...	...																																																												
2n+1	Data point n; Data set 1																																																												
2n+2	Data point n; Data set 2																																																												
Word	Description																																																												
0	Actual number of data points																																																												
1	Data point 0; Data set 1																																																												
2	Data point 0; Data set 2																																																												
3	Data point 0; Data set 3																																																												
4	Data point 0; Data set 4																																																												
5	Data point 0; Data set 5																																																												
6	Data point 0; Data set 6																																																												
7	Data point 0; Data set 7																																																												
8	Data point 0; Data set 8																																																												
9	Data point 1; Data set 1																																																												
10	Data point 1; Data set 2																																																												
...	...																																																												
8n+7	Data point n; Data set 7																																																												
8n+8	Data point n; Data set 8																																																												



Continued

Property	Description																																																												
Read Address	<p>Data Type: 32-bit; Number of Data Sets: 1</p> <table border="1" data-bbox="395 277 1015 533"> <thead> <tr> <th>Word</th> <th>Description</th> </tr> </thead> <tbody> <tr> <td>0,1</td> <td>Actual number of data points</td> </tr> <tr> <td>2,3</td> <td>Data point 0</td> </tr> <tr> <td>4,5</td> <td>Data point 1</td> </tr> <tr> <td>...</td> <td>...</td> </tr> <tr> <td>2n+2, 2n+3</td> <td>Data point n</td> </tr> </tbody> </table> <p>Data Type: 32-bit; Number of Data Sets: 2</p> <table border="1" data-bbox="395 609 1015 994"> <thead> <tr> <th>Word</th> <th>Description</th> </tr> </thead> <tbody> <tr> <td>0,1</td> <td>Actual number of data points</td> </tr> <tr> <td>2,3</td> <td>Data point 0; Data set 1</td> </tr> <tr> <td>4,5</td> <td>Data point 0; Data set 2</td> </tr> <tr> <td>6,7</td> <td>Data point 1; Data set 1</td> </tr> <tr> <td>8,9</td> <td>Data point 1; Data set 2</td> </tr> <tr> <td>...</td> <td>...</td> </tr> <tr> <td>4n+2, 4n+3</td> <td>Data point n; Data set 1</td> </tr> <tr> <td>4n+4, 4n+5</td> <td>Data point n; Data set 2</td> </tr> </tbody> </table> <p>Data Type: 32-bit; Number of Data Sets: 8</p> <table border="1" data-bbox="395 1070 1015 1711"> <thead> <tr> <th>Word</th> <th>Description</th> </tr> </thead> <tbody> <tr> <td>0,1</td> <td>Actual number of data points</td> </tr> <tr> <td>2,3</td> <td>Data point 0; Data set 1</td> </tr> <tr> <td>4,5</td> <td>Data point 0; Data set 2</td> </tr> <tr> <td>6,7</td> <td>Data point 0; Data set 3</td> </tr> <tr> <td>8,9</td> <td>Data point 0; Data set 4</td> </tr> <tr> <td>10,11</td> <td>Data point 0; Data set 5</td> </tr> <tr> <td>12,13</td> <td>Data point 0; Data set 6</td> </tr> <tr> <td>14,15</td> <td>Data point 0; Data set 7</td> </tr> <tr> <td>16,17</td> <td>Data point 0; Data set 8</td> </tr> <tr> <td>18,19</td> <td>Data point 1; Data set 1</td> </tr> <tr> <td>20,21</td> <td>Data point 1; Data set 2</td> </tr> <tr> <td>...</td> <td>...</td> </tr> <tr> <td>16n+14, 16n+15</td> <td>Data point n; Data set 7</td> </tr> <tr> <td>16n+16, 16n+17</td> <td>Data point n; Data set 8</td> </tr> </tbody> </table>	Word	Description	0,1	Actual number of data points	2,3	Data point 0	4,5	Data point 1	2n+2, 2n+3	Data point n	Word	Description	0,1	Actual number of data points	2,3	Data point 0; Data set 1	4,5	Data point 0; Data set 2	6,7	Data point 1; Data set 1	8,9	Data point 1; Data set 2	4n+2, 4n+3	Data point n; Data set 1	4n+4, 4n+5	Data point n; Data set 2	Word	Description	0,1	Actual number of data points	2,3	Data point 0; Data set 1	4,5	Data point 0; Data set 2	6,7	Data point 0; Data set 3	8,9	Data point 0; Data set 4	10,11	Data point 0; Data set 5	12,13	Data point 0; Data set 6	14,15	Data point 0; Data set 7	16,17	Data point 0; Data set 8	18,19	Data point 1; Data set 1	20,21	Data point 1; Data set 2	16n+14, 16n+15	Data point n; Data set 7	16n+16, 16n+17	Data point n; Data set 8
Word	Description																																																												
0,1	Actual number of data points																																																												
2,3	Data point 0																																																												
4,5	Data point 1																																																												
...	...																																																												
2n+2, 2n+3	Data point n																																																												
Word	Description																																																												
0,1	Actual number of data points																																																												
2,3	Data point 0; Data set 1																																																												
4,5	Data point 0; Data set 2																																																												
6,7	Data point 1; Data set 1																																																												
8,9	Data point 1; Data set 2																																																												
...	...																																																												
4n+2, 4n+3	Data point n; Data set 1																																																												
4n+4, 4n+5	Data point n; Data set 2																																																												
Word	Description																																																												
0,1	Actual number of data points																																																												
2,3	Data point 0; Data set 1																																																												
4,5	Data point 0; Data set 2																																																												
6,7	Data point 0; Data set 3																																																												
8,9	Data point 0; Data set 4																																																												
10,11	Data point 0; Data set 5																																																												
12,13	Data point 0; Data set 6																																																												
14,15	Data point 0; Data set 7																																																												
16,17	Data point 0; Data set 8																																																												
18,19	Data point 1; Data set 1																																																												
20,21	Data point 1; Data set 2																																																												
...	...																																																												
16n+14, 16n+15	Data point n; Data set 7																																																												
16n+16, 16n+17	Data point n; Data set 8																																																												
Number of Data Sets	Specifies how many data sets the line chart will read. The line chart displays one line for each data set. A line chart can display up to 8 lines.																																																												
Maximum Number of Data Points Per Data Set	Specifies the maximum number of data points that the line chart will read for every data set. A line chart can display up to 255 data points for one data set. Note: The actual number of data points for every data set must be specified at runtime. The actual number must not exceed the maximum number.																																																												

Continued

Property		Description																							
Point Distribution		<p>Select one of the following methods to distribute the data points of a data set:</p> <table border="1"> <thead> <tr> <th>Method</th> <th>Description</th> </tr> </thead> <tbody> <tr> <td>Maximum Points</td> <td>The data points of a data set are evenly distributed across the X axis of the line chart based on the maximum number of data points for every data set. Therefore, the space between two adjacent data points is fixed.</td> </tr> <tr> <td>Actual Points</td> <td>The data points of a data set are evenly distributed across the X axis of the line chart based on the actual number of data points. When the number of actual data points decreases, the space between two adjacent data points increases.</td> </tr> </tbody> </table>	Method	Description	Maximum Points	The data points of a data set are evenly distributed across the X axis of the line chart based on the maximum number of data points for every data set. Therefore, the space between two adjacent data points is fixed.	Actual Points	The data points of a data set are evenly distributed across the X axis of the line chart based on the actual number of data points. When the number of actual data points decreases, the space between two adjacent data points increases.																	
Method	Description																								
Maximum Points	The data points of a data set are evenly distributed across the X axis of the line chart based on the maximum number of data points for every data set. Therefore, the space between two adjacent data points is fixed.																								
Actual Points	The data points of a data set are evenly distributed across the X axis of the line chart based on the actual number of data points. When the number of actual data points decreases, the space between two adjacent data points increases.																								
Direction		Specifies the direction that the line chart draws the data points.																							
Show Mark		Check this option so the line chart will put a square mark on every data point.																							
Show Line		Check this option so the line chart will display a line connecting all the data points of a data set in sequence.																							
Clear Trigger		The bit variable that will trigger the line chart to clear its content when its state changes from off to on. Click  to enter an address for this field. Click  to select a tag for this field.																							
Cursor	Show Cursor	Check this option so the line chart will display a cursor. You can touch and drag the cursor to the data point(s) that you want to select.																							
	Cursor Color	Select a color for the cursor.																							
	Value Display Font	Select a font for displaying the values of the selected data point(s).																							
	Cursor Data Receiving Buffer	<p>The variable that will receive the value(s) of the selected data point(s). It must be a piece of the internal memory.</p> <p>Click  to enter an address for this field. Click  to select a tag for this field.</p> <p>The following table shows the data arrangement of the buffer when the data type is 16-bit.</p> <table border="1"> <thead> <tr> <th>Word</th> <th>Description</th> </tr> </thead> <tbody> <tr> <td>0</td> <td>The sequence number of the cursor selected data in the data set</td> </tr> <tr> <td>1</td> <td>The value of the selected data point of data set 1.</td> </tr> <tr> <td>2</td> <td>The value of the selected data point of data set 2.</td> </tr> <tr> <td>...</td> <td>...</td> </tr> <tr> <td>8</td> <td>The value of the selected data point of data set 8.</td> </tr> </tbody> </table> <p>The following table shows the data arrangement of the buffer when the data type is 32-bit.</p> <table border="1"> <thead> <tr> <th>Word</th> <th>Description</th> </tr> </thead> <tbody> <tr> <td>0,1</td> <td>The sequence number of the cursor selected data in the data set</td> </tr> <tr> <td>2,3</td> <td>The value of the selected data point of data set 1.</td> </tr> <tr> <td>4,5</td> <td>The value of the selected data point of data set 2.</td> </tr> <tr> <td>...</td> <td>...</td> </tr> <tr> <td>16,17</td> <td>The value of the selected data point of data set 8.</td> </tr> </tbody> </table>	Word	Description	0	The sequence number of the cursor selected data in the data set	1	The value of the selected data point of data set 1.	2	The value of the selected data point of data set 2.	8	The value of the selected data point of data set 8.	Word	Description	0,1	The sequence number of the cursor selected data in the data set	2,3	The value of the selected data point of data set 1.	4,5	The value of the selected data point of data set 2.	16,17
Word	Description																								
0	The sequence number of the cursor selected data in the data set																								
1	The value of the selected data point of data set 1.																								
2	The value of the selected data point of data set 2.																								
...	...																								
8	The value of the selected data point of data set 8.																								
Word	Description																								
0,1	The sequence number of the cursor selected data in the data set																								
2,3	The value of the selected data point of data set 1.																								
4,5	The value of the selected data point of data set 2.																								
...	...																								
16,17	The value of the selected data point of data set 8.																								

Continued

Property		Description																																															
Dynamic Range	Dynamic Range	Check this option so the minimum and the maximum of the pen for each data set will be specified at runtime. When this option is selected, the minimum and maximum of the marks for the X axis and Y axis can be specified at runtime too. The data that specifies the above two ranges should be set and arranged correctly in a memory block called the dynamic range parameter block. You need to specify the dynamic range parameter block in the Dynamic Range Parameter Block field.																																															
	Dynamic Range Parameter Block	<p>Specifies the variable that stores the dynamic range parameter block for the line chart when the Dynamic Range is selected. Click  to enter an address for this field. Click  to select a tag for this field.</p> <p>The following table shows the data arrangement of the parameter block when the data type is 16-bit.</p> <table border="1"> <thead> <tr> <th>Word</th> <th>Description</th> </tr> </thead> <tbody> <tr> <td>0,1</td> <td>The minimum of the mark for the X axis; 32-bit integer number</td> </tr> <tr> <td>2,3</td> <td>The maximum of the mark for the X axis; 32-bit integer number</td> </tr> <tr> <td>4,5</td> <td>The minimum of the mark for the Y axis; 32-bit integer number</td> </tr> <tr> <td>6,7</td> <td>The maximum of the mark for the Y axis; 32-bit integer number</td> </tr> <tr> <td>8</td> <td>The minimum for pen #1; 16-bit integer number or 16-bit unsigned integer number</td> </tr> <tr> <td>9</td> <td>The maximum for pen #1; (Same as above)</td> </tr> <tr> <td>10</td> <td>The minimum for pen #2; (Same as above)</td> </tr> <tr> <td>11</td> <td>The maximum for pen #2; (Same as above)</td> </tr> <tr> <td>...</td> <td>...</td> </tr> <tr> <td>22</td> <td>The minimum for pen #8; (Same as above)</td> </tr> <tr> <td>23</td> <td>The maximum for pen #8; (Same as above)</td> </tr> </tbody> </table> <p>The following table shows the data arrangement of the parameter block when the data type is 32-bit.</p> <table border="1"> <thead> <tr> <th>Word</th> <th>Description</th> </tr> </thead> <tbody> <tr> <td>0,1</td> <td>The minimum of the mark for the X axis; 32-bit integer number</td> </tr> <tr> <td>2,3</td> <td>The maximum of the mark for the X axis; 32-bit integer number</td> </tr> <tr> <td>4,5</td> <td>The minimum of the mark for the Y axis; 32-bit integer number</td> </tr> <tr> <td>6,7</td> <td>The maximum of the mark for the Y axis; 32-bit integer number</td> </tr> <tr> <td>8,9</td> <td>The minimum for pen #1; 32-bit integer number, 32-bit unsigned integer number, or 32-bit floating point number</td> </tr> <tr> <td>10,11</td> <td>The maximum for pen #1; (Same as above)</td> </tr> <tr> <td>12,13</td> <td>The minimum for pen #2; (Same as above)</td> </tr> <tr> <td>14,15</td> <td>The maximum for pen #2; (Same as above)</td> </tr> <tr> <td>...</td> <td>...</td> </tr> <tr> <td>36,37</td> <td>The minimum for pen #8; (Same as above)</td> </tr> <tr> <td>38,39</td> <td>The maximum for pen #8; (Same as above)</td> </tr> </tbody> </table>	Word	Description	0,1	The minimum of the mark for the X axis; 32-bit integer number	2,3	The maximum of the mark for the X axis; 32-bit integer number	4,5	The minimum of the mark for the Y axis; 32-bit integer number	6,7	The maximum of the mark for the Y axis; 32-bit integer number	8	The minimum for pen #1; 16-bit integer number or 16-bit unsigned integer number	9	The maximum for pen #1; (Same as above)	10	The minimum for pen #2; (Same as above)	11	The maximum for pen #2; (Same as above)	22	The minimum for pen #8; (Same as above)	23	The maximum for pen #8; (Same as above)	Word	Description	0,1	The minimum of the mark for the X axis; 32-bit integer number	2,3	The maximum of the mark for the X axis; 32-bit integer number	4,5	The minimum of the mark for the Y axis; 32-bit integer number	6,7	The maximum of the mark for the Y axis; 32-bit integer number	8,9	The minimum for pen #1; 32-bit integer number, 32-bit unsigned integer number, or 32-bit floating point number	10,11	The maximum for pen #1; (Same as above)	12,13	The minimum for pen #2; (Same as above)	14,15	The maximum for pen #2; (Same as above)	36,37	The minimum for pen #8; (Same as above)	38,39
Word	Description																																																
0,1	The minimum of the mark for the X axis; 32-bit integer number																																																
2,3	The maximum of the mark for the X axis; 32-bit integer number																																																
4,5	The minimum of the mark for the Y axis; 32-bit integer number																																																
6,7	The maximum of the mark for the Y axis; 32-bit integer number																																																
8	The minimum for pen #1; 16-bit integer number or 16-bit unsigned integer number																																																
9	The maximum for pen #1; (Same as above)																																																
10	The minimum for pen #2; (Same as above)																																																
11	The maximum for pen #2; (Same as above)																																																
...	...																																																
22	The minimum for pen #8; (Same as above)																																																
23	The maximum for pen #8; (Same as above)																																																
Word	Description																																																
0,1	The minimum of the mark for the X axis; 32-bit integer number																																																
2,3	The maximum of the mark for the X axis; 32-bit integer number																																																
4,5	The minimum of the mark for the Y axis; 32-bit integer number																																																
6,7	The maximum of the mark for the Y axis; 32-bit integer number																																																
8,9	The minimum for pen #1; 32-bit integer number, 32-bit unsigned integer number, or 32-bit floating point number																																																
10,11	The maximum for pen #1; (Same as above)																																																
12,13	The minimum for pen #2; (Same as above)																																																
14,15	The maximum for pen #2; (Same as above)																																																
...	...																																																
36,37	The minimum for pen #8; (Same as above)																																																
38,39	The maximum for pen #8; (Same as above)																																																

8.4.5. Pen Settings

This section describes how to define the pens for the line charts. The following is an example of the Pen page.

The screenshot shows the 'Pen' tab of a settings dialog with eight pen configurations. Each configuration includes a 'Dynamic Range' checkbox, 'Min.' and 'Max.' input fields, 'Mark Size' spinner, 'Line Style' dropdown, 'Color' color picker, and 'Show Value' dropdown.

Pen #	Dynamic Range	Min.	Max.	Mark Size	Line Style	Color	Show Value
Pen #1	<input type="checkbox"/>	0	100	4	Solid	Blue	Original
Pen #2	<input type="checkbox"/>	0	100	4	Solid	Green	Original
Pen #3	<input checked="" type="checkbox"/>			2	Solid	Cyan	Scaled
Pen #4	<input checked="" type="checkbox"/>			2	Solid	Red	Scaled
Pen #5	<input type="checkbox"/>	0	100	2	Dashed	Magenta	(None)
Pen #6	<input type="checkbox"/>	0	100	2	Dashed	Yellow	(None)
Pen #7	<input type="checkbox"/>	0	100	2	Dashed	Orange	(None)
Pen #8	<input type="checkbox"/>	0	100	2	Dashed	Light Green	(None)

The following table describes each property in the Pen page. Note that pen #1 is for data set 1; pen #2 is for data set 2; and so on.

Property		Description							
Pen #1 to Pen #8	Dynamic Range	Check this option so the minimum and the maximum of the associated data set will be specified at runtime. This option is available when the Dynamic Range option in the General page is selected.							
	Min.	The minimum of the associated data set. This property is available when the Dynamic Range option is not selected.							
	Max.	The maximum of the associated data set. This property is available when the Dynamic Range option is not selected.							
	Mark Size	Select a size for the data point mark. The selection is valid when the Show Mark option in the General page is selected.							
	Line Style	Select a style for the connecting lines. The selection is valid when the Show Line option in the General page is selected.							
	Color	Select a color for the connecting lines.							
	Show Value	Select one of the following methods for displaying the selected data point value. <table border="1"> <thead> <tr> <th>Show Value</th> <th>Description</th> </tr> </thead> <tbody> <tr> <td>(None)</td> <td>Does not display the data point value.</td> </tr> <tr> <td>Original</td> <td>Displays the data point value without modification.</td> </tr> <tr> <td>Scaled</td> <td>Displays the corresponding Y axis value of the data point.</td> </tr> </tbody> </table> <p>The selection is valid when the Show Cursor option in the General page is selected.</p>	Show Value	Description	(None)	Does not display the data point value.	Original	Displays the data point value without modification.	Scaled
Show Value	Description								
(None)	Does not display the data point value.								
Original	Displays the data point value without modification.								
Scaled	Displays the corresponding Y axis value of the data point.								

8.4.6. Axis Settings

This section describes how to define the X axis and the Y axis for the line charts and the scatter charts.

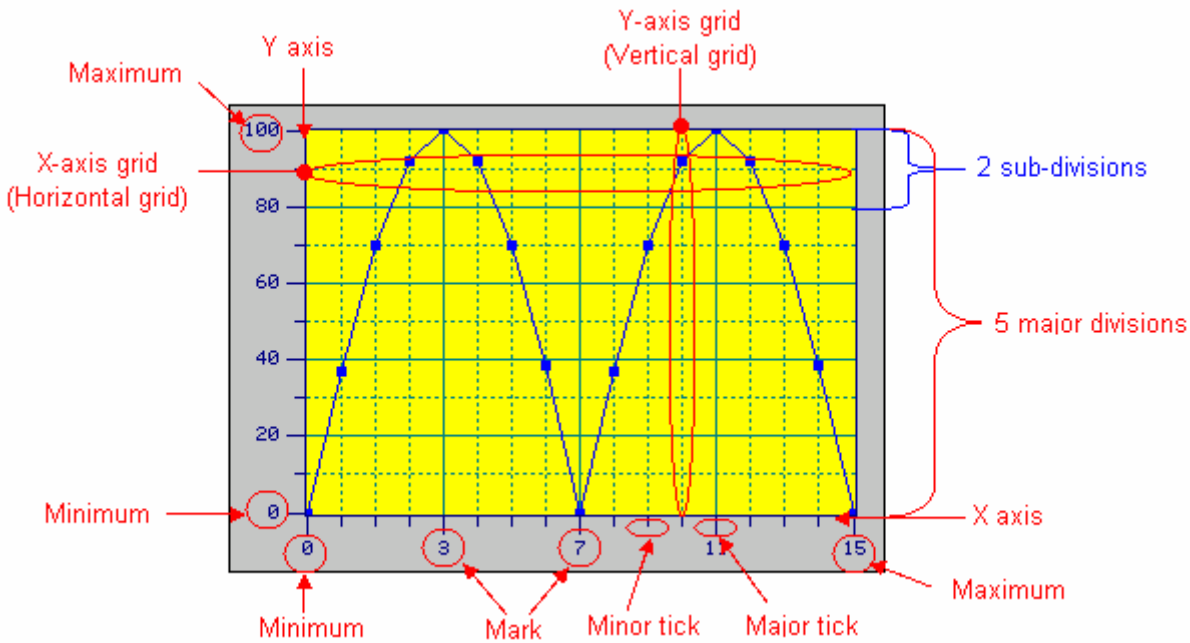

The following is an example of the Axis page.

General	Pen	Axis	Visibility
<div style="display: flex; justify-content: space-between;"> <div style="width: 48%;"> <p>X Axis</p> <p><input checked="" type="checkbox"/> Show Ticks</p> <p><input checked="" type="checkbox"/> Show Y-Axis Grid</p> <p>Axis/Tick Color: </p> <p>Grid Color: </p> <p>Number of Major Divisions: <input type="text" value="4"/></p> <p>Number of Sub-divisions: <input type="text" value="4"/></p> <p><input checked="" type="checkbox"/> Show Marks</p> <p>Font: <input checked="" type="radio"/> 6x8 <input type="radio"/> 8x12 <input type="radio"/> 12x16</p> <p><input type="checkbox"/> Dynamic Range</p> <p>Min.: <input type="text" value="0"/> Max.: <input type="text" value="15"/></p> <p>Total Digits: <input type="text" value="2"/></p> <p>Fractional Digits: <input type="text" value="0"/></p> </div> <div style="width: 48%;"> <p>Y Axis</p> <p><input checked="" type="checkbox"/> Show Ticks</p> <p><input checked="" type="checkbox"/> Show X-Axis Grid</p> <p>Axis/Tick Color: </p> <p>Grid Color: </p> <p>Number of Major Divisions: <input type="text" value="5"/></p> <p>Number of Sub-divisions: <input type="text" value="2"/></p> <p><input checked="" type="checkbox"/> Show Marks</p> <p>Font: <input checked="" type="radio"/> 6x8 <input type="radio"/> 8x12 <input type="radio"/> 12x16</p> <p><input type="checkbox"/> Dynamic Range</p> <p>Min.: <input type="text" value="0"/> Max.: <input type="text" value="100"/></p> <p>Total Digits: <input type="text" value="3"/></p> <p>Fractional Digits: <input type="text" value="0"/></p> </div> </div>			

The following table describes each property in the Axis page.

Property		Description
X Axis	Show Ticks	Check this option if you want the X axis to have ticks.
	Show Y-axis Grid	Select this option if you want the X axis to have vertical grids.
	Axis/Tick Color	Select a color for the X axis and its ticks.
	Grid Color	Select a color for the vertical grids.
	Number of Major Divisions	The number of major divisions for the X axis. The minimum you can specify is one.
	Number of Sub-divisions	The number of divisions between two adjacent major ticks. The minimum you can specify is one.
Mark	Show Marks	Check this option if you want the major ticks to have marks.
	Font	The font of the marks.
	Dynamic Range	Check this option if you want the minimum and maximum of the marks to be controlled by the dynamic range parameter block of the associated object at runtime.
	Min.	The minimum of the marks. It is a 32-bit integer.
	Max.	The maximum of the marks. It is a 32-bit integer.
	Total Digits	The total digits to be displayed for the marks.
	Fractional Digits	The number of fractional digits for the marks. For example, when the Maximum is 5000, the Total Digits is 4, and the Fractional Digits is 2, the mark for the Maximum will be 50.00.
Y Axis	Show Ticks	Check this option if you want the Y axis to have ticks.
	Show X-axis Grid	Select this option if you want the Y axis to have horizontal grids.
	Axis/Tick Color	Select a color for the Y axis and its ticks.
	Grid Color	Select a color for the horizontal grids.
	Number of Major Divisions	The number of major divisions for the Y axis. The minimum you can specify is one.
	Number of Sub-divisions	The number of divisions between two adjacent major ticks. The minimum you can specify is one.
Mark	Show Marks	Check this option if you want the major ticks to have marks.
	Font	The font of the marks.
	Dynamic Range	Check this option if you want the minimum and maximum of the marks to be controlled by the dynamic range parameter block of the associated object at runtime.
	Min.	The minimum of the marks. You can specify a 32-bit signed integer.
	Max.	The maximum of the marks. You can specify a 32-bit signed integer.
	Total Digits	The total digits to be displayed for the marks.
	Fractional Digits	The number of fractional digits for the marks. For example, when the Maximum is 5000, the Total Digits is 4, and the Fractional Digits is 2, the mark for the Maximum will be 50.00.

8.5. Scatter Charts

8.5.1. Basic Operations

A scatter chart displays a set of data by drawing a data point for each datum and drawing a line that connects all the data points in sequence. Each datum is a coordinate that contains an X value and a Y value. The vertical position of a data point is determined by the X value of the associated datum. The horizontal position of a data point is determined by the Y value of the associated datum.

Number of data points	5	
	X	Y
Data point 0	0	80
Data point 1	50	100
Data point 2	90	40
Data point 3	50	30
Data point 4	30	10

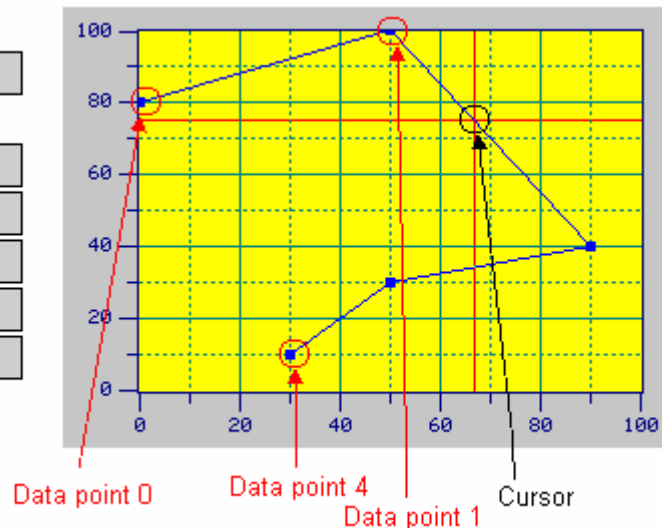

A scatter chart can display up to 8 sets of data. The following example shows a scatter chart that displays 3 sets of data.

Number of data points	5					
	Data set 1		Data set 2		Data set 3	
	X	Y	X	Y	X	Y
Data point 0	0	80	10	90	20	70
Data point 1	50	100	60	90	70	100
Data point 2	90	40	100	50	90	60
Data point 3	50	30	60	40	70	50
Data point 4	30	10	20	10	30	30

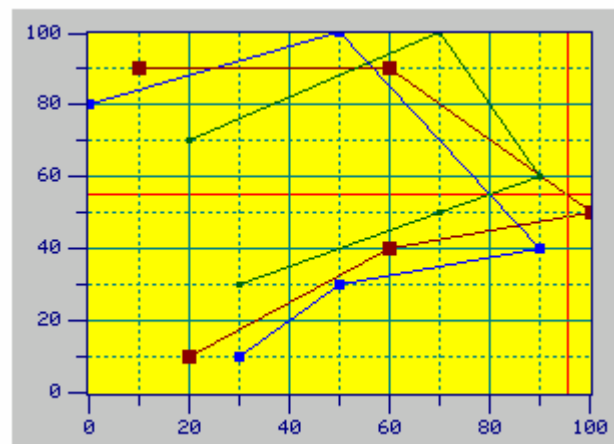

8.5.2. Operation Options

The following operation option can be added to a scatter chart. Select and set the option in the Scatter Chart dialog box.

Options	Description
Visibility Control	You can show and hide a scatter chart by a specified bit or the current user level. Select and set this option in the Visibility page.

8.5.3. Settings

You can complete all the settings of a scatter chart in the Scatter Chart dialog box. This dialog box contains the following four pages.

- **General**

Described in [Section 8.5.4.](#)

- **Pen**

Described in [Section 8.5.5.](#)

- **XY Axis**

Described in [Section 8.4.6.](#)

- **Visibility**



Described in [Section 4.4.6.](#)

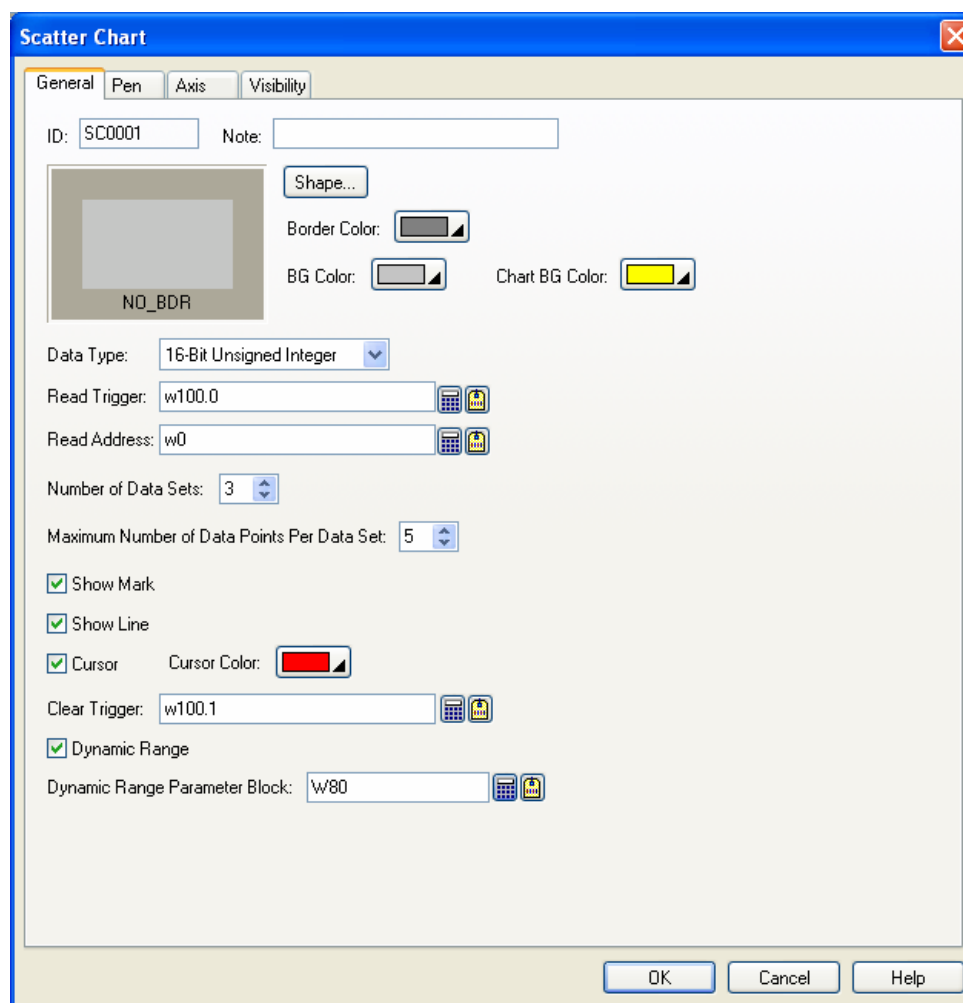

8.5.4. General Settings

This section describes how to define the general settings for a scatter chart. The following is an example of the General page of the Scatter Chart property sheet.

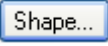



The following table describes each property in the General page.



Property	Description
ID	The object's identifier. It is generated when the object is created. The identifier is unique within the screen where the object is located. The format of the IDs for the scatter charts is SCnnnn.
Note	You can type a note for the object.
Shape settings	For details about the following properties, see Section 4.3.1.4 Setting up the Shape of an Object .  , Border Color, BG Color
Chart BG Color	Select a color for the background of the char.
Data Type	The type of the data that the scatter chart will display. The supported data types include: 16-Bit Unsigned Integer, 32-Bit Unsigned Integer, 16-Bit Signed Integer, 32-Bit Signed Integer, 16-Bit BCD, 32-Bit BCD, 32-Bit Floating Point, 16-Bit Signed BCD (LMB), 32-Bit Signed BCD (LMB), 16-Bit Signed BCD (LMD), and 32-Bit Signed BCD (LMD).
Read Trigger	The bit variable that will trigger the scatter chart to read and display data. The bit variable triggers the scatter chart when its state changes from off to on. Click  to enter an address for this field. Click  to select a tag for this field.

Property	Description																																																																																												
Read Address	<p>The variable whose data is to be read and displayed. Click  to enter an address for this field. Click  to select a tag for this field.</p> <p>The following tables show the data arrangements of the variable.</p> <p>Data Type: 16-bit; Number of Data Sets: 1</p> <table border="1"> <thead> <tr> <th>Word</th> <th>Description</th> </tr> </thead> <tbody> <tr> <td>0</td> <td>Actual number of data points</td> </tr> <tr> <td>1</td> <td>X value of data point 0</td> </tr> <tr> <td>2</td> <td>Y value of data point 0</td> </tr> <tr> <td>3</td> <td>X value of data point 1</td> </tr> <tr> <td>4</td> <td>Y value of data point 1</td> </tr> <tr> <td>...</td> <td>...</td> </tr> <tr> <td>2n+1</td> <td>X value of data point n</td> </tr> <tr> <td>2n+2</td> <td>Y value of data point n</td> </tr> </tbody> </table> <p>Data Type: 16-bit; Number of Data Sets: 2</p> <table border="1"> <thead> <tr> <th>Word</th> <th>Description</th> </tr> </thead> <tbody> <tr> <td>0</td> <td>Actual number of data points</td> </tr> <tr> <td>1</td> <td>X value of data point 0; Data set 1</td> </tr> <tr> <td>2</td> <td>Y value of data point 0; Data set 1</td> </tr> <tr> <td>3</td> <td>X value of data point 0; Data set 2</td> </tr> <tr> <td>4</td> <td>Y value of data point 0; Data set 2</td> </tr> <tr> <td>5</td> <td>X value of data point 1; Data set 1</td> </tr> <tr> <td>6</td> <td>Y value of data point 1; Data set 1</td> </tr> <tr> <td>7</td> <td>X value of data point 1; Data set 2</td> </tr> <tr> <td>8</td> <td>Y value of data point 1; Data set 2</td> </tr> <tr> <td>...</td> <td>...</td> </tr> <tr> <td>4n+3</td> <td>X value of data point n; Data set 2</td> </tr> <tr> <td>4n+4</td> <td>Y value of data point n; Data set 2</td> </tr> </tbody> </table> <p>Data Type: 16-bit; Number of Data Sets: 8</p> <table border="1"> <thead> <tr> <th>Word</th> <th>Description</th> <th>Word</th> <th>Description</th> </tr> </thead> <tbody> <tr> <td>0</td> <td>Actual number of data points</td> <td>11</td> <td>X value of data point 0; Data set 6</td> </tr> <tr> <td>1</td> <td>X value of data point 0; Data set 1</td> <td>12</td> <td>Y value of data point 0; Data set 6</td> </tr> <tr> <td>2</td> <td>Y value of data point 0; Data set 1</td> <td>13</td> <td>X value of data point 0; Data set 7</td> </tr> <tr> <td>3</td> <td>X value of data point 0; Data set 2</td> <td>14</td> <td>Y value of data point 0; Data set 7</td> </tr> <tr> <td>4</td> <td>Y value of data point 0; Data set 2</td> <td>15</td> <td>X value of data point 0; Data set 8</td> </tr> <tr> <td>5</td> <td>X value of data point 0; Data set 3</td> <td>16</td> <td>Y value of data point 0; Data set 8</td> </tr> <tr> <td>6</td> <td>Y value of data point 0; Data set 3</td> <td>17</td> <td>X value of data point 1; Data set 1</td> </tr> <tr> <td>7</td> <td>X value of data point 0; Data set 4</td> <td>18</td> <td>Y value of data point 1; Data set 1</td> </tr> <tr> <td>8</td> <td>Y value of data point 0; Data set 4</td> <td>...</td> <td>...</td> </tr> <tr> <td>9</td> <td>X value of data point 0; Data set 5</td> <td>16n+15</td> <td>X value of data point n; Data set 8</td> </tr> <tr> <td>10</td> <td>Y value of data point 0; Data set 5</td> <td>16n+16</td> <td>Y value of data point n; Data set 8</td> </tr> </tbody> </table>	Word	Description	0	Actual number of data points	1	X value of data point 0	2	Y value of data point 0	3	X value of data point 1	4	Y value of data point 1	2n+1	X value of data point n	2n+2	Y value of data point n	Word	Description	0	Actual number of data points	1	X value of data point 0; Data set 1	2	Y value of data point 0; Data set 1	3	X value of data point 0; Data set 2	4	Y value of data point 0; Data set 2	5	X value of data point 1; Data set 1	6	Y value of data point 1; Data set 1	7	X value of data point 1; Data set 2	8	Y value of data point 1; Data set 2	4n+3	X value of data point n; Data set 2	4n+4	Y value of data point n; Data set 2	Word	Description	Word	Description	0	Actual number of data points	11	X value of data point 0; Data set 6	1	X value of data point 0; Data set 1	12	Y value of data point 0; Data set 6	2	Y value of data point 0; Data set 1	13	X value of data point 0; Data set 7	3	X value of data point 0; Data set 2	14	Y value of data point 0; Data set 7	4	Y value of data point 0; Data set 2	15	X value of data point 0; Data set 8	5	X value of data point 0; Data set 3	16	Y value of data point 0; Data set 8	6	Y value of data point 0; Data set 3	17	X value of data point 1; Data set 1	7	X value of data point 0; Data set 4	18	Y value of data point 1; Data set 1	8	Y value of data point 0; Data set 4	9	X value of data point 0; Data set 5	16n+15	X value of data point n; Data set 8	10	Y value of data point 0; Data set 5	16n+16	Y value of data point n; Data set 8
Word	Description																																																																																												
0	Actual number of data points																																																																																												
1	X value of data point 0																																																																																												
2	Y value of data point 0																																																																																												
3	X value of data point 1																																																																																												
4	Y value of data point 1																																																																																												
...	...																																																																																												
2n+1	X value of data point n																																																																																												
2n+2	Y value of data point n																																																																																												
Word	Description																																																																																												
0	Actual number of data points																																																																																												
1	X value of data point 0; Data set 1																																																																																												
2	Y value of data point 0; Data set 1																																																																																												
3	X value of data point 0; Data set 2																																																																																												
4	Y value of data point 0; Data set 2																																																																																												
5	X value of data point 1; Data set 1																																																																																												
6	Y value of data point 1; Data set 1																																																																																												
7	X value of data point 1; Data set 2																																																																																												
8	Y value of data point 1; Data set 2																																																																																												
...	...																																																																																												
4n+3	X value of data point n; Data set 2																																																																																												
4n+4	Y value of data point n; Data set 2																																																																																												
Word	Description	Word	Description																																																																																										
0	Actual number of data points	11	X value of data point 0; Data set 6																																																																																										
1	X value of data point 0; Data set 1	12	Y value of data point 0; Data set 6																																																																																										
2	Y value of data point 0; Data set 1	13	X value of data point 0; Data set 7																																																																																										
3	X value of data point 0; Data set 2	14	Y value of data point 0; Data set 7																																																																																										
4	Y value of data point 0; Data set 2	15	X value of data point 0; Data set 8																																																																																										
5	X value of data point 0; Data set 3	16	Y value of data point 0; Data set 8																																																																																										
6	Y value of data point 0; Data set 3	17	X value of data point 1; Data set 1																																																																																										
7	X value of data point 0; Data set 4	18	Y value of data point 1; Data set 1																																																																																										
8	Y value of data point 0; Data set 4																																																																																										
9	X value of data point 0; Data set 5	16n+15	X value of data point n; Data set 8																																																																																										
10	Y value of data point 0; Data set 5	16n+16	Y value of data point n; Data set 8																																																																																										

Continued

Property	Description																																																
Read Address	Data Type: 32-bit; Number of Data Sets: 1																																																
	<table border="1"> <thead> <tr> <th>Word</th> <th>Description</th> <th>Word</th> <th>Description</th> </tr> </thead> <tbody> <tr> <td>0,1</td> <td>Actual number of data points</td> <td>8,9</td> <td>Y value of data point 1</td> </tr> <tr> <td>2,3</td> <td>X value of data point 0</td> <td>...</td> <td>...</td> </tr> <tr> <td>4,5</td> <td>Y value of data point 0</td> <td>4n+2, 4n+3</td> <td>X value of data point n</td> </tr> <tr> <td>6,7</td> <td>X value of data point 1</td> <td>4n+4, 4n+5</td> <td>Y value of data point n</td> </tr> </tbody> </table>	Word	Description	Word	Description	0,1	Actual number of data points	8,9	Y value of data point 1	2,3	X value of data point 0	4,5	Y value of data point 0	4n+2, 4n+3	X value of data point n	6,7	X value of data point 1	4n+4, 4n+5	Y value of data point n																												
	Word	Description	Word	Description																																													
	0,1	Actual number of data points	8,9	Y value of data point 1																																													
	2,3	X value of data point 0																																													
	4,5	Y value of data point 0	4n+2, 4n+3	X value of data point n																																													
	6,7	X value of data point 1	4n+4, 4n+5	Y value of data point n																																													
	Data Type: 32-bit; Number of Data Sets: 2																																																
	<table border="1"> <thead> <tr> <th>Word</th> <th>Description</th> <th>Word</th> <th>Description</th> </tr> </thead> <tbody> <tr> <td>0,1</td> <td>Actual number of data points</td> <td>12,13</td> <td>Y value of data point 1; Data set 1</td> </tr> <tr> <td>2,3</td> <td>X value of data point 0; Data set 1</td> <td>14,15</td> <td>X value of data point 1; Data set 2</td> </tr> <tr> <td>4,5</td> <td>Y value of data point 0; Data set 1</td> <td>16,17</td> <td>Y value of data point 1; Data set 2</td> </tr> <tr> <td>6,7</td> <td>X value of data point 0; Data set 2</td> <td>...</td> <td>...</td> </tr> <tr> <td>8,9</td> <td>Y value of data point 0; Data set 2</td> <td>8n+6, 8n+7</td> <td>X value of data point n; Data set 2</td> </tr> <tr> <td>10,11</td> <td>X value of data point 1; Data set 1</td> <td>8n+8, 8n+9</td> <td>Y value of data point n; Data set 2</td> </tr> </tbody> </table>	Word	Description	Word	Description	0,1	Actual number of data points	12,13	Y value of data point 1; Data set 1	2,3	X value of data point 0; Data set 1	14,15	X value of data point 1; Data set 2	4,5	Y value of data point 0; Data set 1	16,17	Y value of data point 1; Data set 2	6,7	X value of data point 0; Data set 2	8,9	Y value of data point 0; Data set 2	8n+6, 8n+7	X value of data point n; Data set 2	10,11	X value of data point 1; Data set 1	8n+8, 8n+9	Y value of data point n; Data set 2																				
	Word	Description	Word	Description																																													
	0,1	Actual number of data points	12,13	Y value of data point 1; Data set 1																																													
	2,3	X value of data point 0; Data set 1	14,15	X value of data point 1; Data set 2																																													
	4,5	Y value of data point 0; Data set 1	16,17	Y value of data point 1; Data set 2																																													
	6,7	X value of data point 0; Data set 2																																													
	8,9	Y value of data point 0; Data set 2	8n+6, 8n+7	X value of data point n; Data set 2																																													
	10,11	X value of data point 1; Data set 1	8n+8, 8n+9	Y value of data point n; Data set 2																																													
	Data Type: 32-bit; Number of Data Sets: 8																																																
	<table border="1"> <thead> <tr> <th>Word</th> <th>Description</th> <th>Word</th> <th>Description</th> </tr> </thead> <tbody> <tr> <td>0,1</td> <td>Actual number of data points</td> <td>22,23</td> <td>X value of data point 0; Data set 6</td> </tr> <tr> <td>2,3</td> <td>X value of data point 0; Data set 1</td> <td>24,25</td> <td>Y value of data point 0; Data set 6</td> </tr> <tr> <td>4,5</td> <td>Y value of data point 0; Data set 1</td> <td>26,27</td> <td>X value of data point 0; Data set 7</td> </tr> <tr> <td>6,7</td> <td>X value of data point 0; Data set 2</td> <td>28,29</td> <td>Y value of data point 0; Data set 7</td> </tr> <tr> <td>8,9</td> <td>Y value of data point 0; Data set 2</td> <td>30,31</td> <td>X value of data point 0; Data set 8</td> </tr> <tr> <td>10,11</td> <td>X value of data point 0; Data set 3</td> <td>32,33</td> <td>Y value of data point 0; Data set 8</td> </tr> <tr> <td>12,13</td> <td>Y value of data point 0; Data set 3</td> <td>34,35</td> <td>X value of data point 1; Data set 1</td> </tr> <tr> <td>14,15</td> <td>X value of data point 0; Data set 4</td> <td>36,37</td> <td>Y value of data point 1; Data set 1</td> </tr> <tr> <td>16,17</td> <td>Y value of data point 0; Data set 4</td> <td>...</td> <td>...</td> </tr> <tr> <td>18,19</td> <td>X value of data point 0; Data set 5</td> <td>32n+30, 32n+31</td> <td>X value of data point n; Data set 8</td> </tr> <tr> <td>20,21</td> <td>Y value of data point 0; Data set 5</td> <td>32n+32, 32n+33</td> <td>Y value of data point n; Data set 8</td> </tr> </tbody> </table>	Word	Description	Word	Description	0,1	Actual number of data points	22,23	X value of data point 0; Data set 6	2,3	X value of data point 0; Data set 1	24,25	Y value of data point 0; Data set 6	4,5	Y value of data point 0; Data set 1	26,27	X value of data point 0; Data set 7	6,7	X value of data point 0; Data set 2	28,29	Y value of data point 0; Data set 7	8,9	Y value of data point 0; Data set 2	30,31	X value of data point 0; Data set 8	10,11	X value of data point 0; Data set 3	32,33	Y value of data point 0; Data set 8	12,13	Y value of data point 0; Data set 3	34,35	X value of data point 1; Data set 1	14,15	X value of data point 0; Data set 4	36,37	Y value of data point 1; Data set 1	16,17	Y value of data point 0; Data set 4	18,19	X value of data point 0; Data set 5	32n+30, 32n+31	X value of data point n; Data set 8	20,21	Y value of data point 0; Data set 5	32n+32, 32n+33	Y value of data point n; Data set 8
	Word	Description	Word	Description																																													
	0,1	Actual number of data points	22,23	X value of data point 0; Data set 6																																													
	2,3	X value of data point 0; Data set 1	24,25	Y value of data point 0; Data set 6																																													
	4,5	Y value of data point 0; Data set 1	26,27	X value of data point 0; Data set 7																																													
	6,7	X value of data point 0; Data set 2	28,29	Y value of data point 0; Data set 7																																													
	8,9	Y value of data point 0; Data set 2	30,31	X value of data point 0; Data set 8																																													
	10,11	X value of data point 0; Data set 3	32,33	Y value of data point 0; Data set 8																																													
	12,13	Y value of data point 0; Data set 3	34,35	X value of data point 1; Data set 1																																													
	14,15	X value of data point 0; Data set 4	36,37	Y value of data point 1; Data set 1																																													
	16,17	Y value of data point 0; Data set 4																																													
	18,19	X value of data point 0; Data set 5	32n+30, 32n+31	X value of data point n; Data set 8																																													
	20,21	Y value of data point 0; Data set 5	32n+32, 32n+33	Y value of data point n; Data set 8																																													
	Number of Data Sets	Specifies how many data sets the scatter chart will display. A scatter chart can display up to 8 sets of data.																																															
	Maximum Number of Data Points Per Data Set	Specifies the maximum number of data points that the scatter chart will display for every data set. A scatter chart can display up to 255 data points for one data set. Note: The actual number of data points for every data set is specified at runtime. The actual number must not exceed the maximum number.																																															
	Show Mark	Check this option so the scatter chart will show a square mark on every data point.																																															
Show Line	Check this option so the scatter chart will display a line between two adjacent data points of a data set.																																																
Clear Trigger	The bit variable that triggers the scatter chart to clear its content when its state changes from off to on. Click  to enter an address for this field. Click  to select a tag for this field.																																																

Continued

Property		Description																																																							
Cursor	Show Cursor	Check this option so the scatter chart will display a cursor. You can touch and drag the cursor within the chart.																																																							
	Cursor Color	Select a color for the cursor.																																																							
Dynamic Range	Dynamic Range	Check this option so the minimum and the maximum for the X and Y values of each data set can be specified at runtime. When this option is selected, the minimum and maximum of the marks for the X axis and Y axis can be specified at runtime as well. The data that specifies the above two ranges should be set and arranged correctly in a memory block called the dynamic range parameter block. You need to specify the dynamic range parameter block in the Dynamic Range Parameter Block field.																																																							
	Dynamic Range Parameter Block	<p>Specifies the variable that stores the dynamic range parameter block for the line chart when Dynamic Range is selected.</p> <p>Click  to enter an address for this field. Click  to select a tag for this field.</p> <p>The following table shows the data arrangement of the parameter block when the data type is 16-bit.</p> <table border="1"> <thead> <tr> <th>Word</th> <th>Description</th> </tr> </thead> <tbody> <tr> <td>0,1</td> <td>The minimum of the mark for the X axis; 32-bit integer number</td> </tr> <tr> <td>2,3</td> <td>The maximum of the mark for the X axis; 32-bit integer number</td> </tr> <tr> <td>4,5</td> <td>The minimum of the mark for the Y axis; 32-bit integer number</td> </tr> <tr> <td>6,7</td> <td>The maximum of the mark for the Y axis; 32-bit integer number</td> </tr> <tr> <td>8</td> <td>The minimum of X values for pen #1; 16-bit integer number or 16-bit unsigned integer number</td> </tr> <tr> <td>9</td> <td>The maximum of X values for pen #1; (Same as above)</td> </tr> <tr> <td>10</td> <td>The minimum of Y values for pen #1; (Same as above)</td> </tr> <tr> <td>11</td> <td>The maximum of Y values for pen #1; (Same as above)</td> </tr> <tr> <td>12</td> <td>The minimum of X values for pen #2; (Same as above)</td> </tr> <tr> <td>13</td> <td>The maximum of X values for pen #2; (Same as above)</td> </tr> <tr> <td>...</td> <td>...</td> </tr> <tr> <td>38</td> <td>The minimum of Y values for pen #8; (Same as above)</td> </tr> <tr> <td>39</td> <td>The maximum of Y values for pen #8; (Same as above)</td> </tr> </tbody> </table> <p>The following table shows the data arrangement of the parameter block when the data type is 32-bit.</p> <table border="1"> <thead> <tr> <th>Word</th> <th>Description</th> </tr> </thead> <tbody> <tr> <td>0,1</td> <td>The minimum of the mark for the X axis; 32-bit integer number</td> </tr> <tr> <td>2,3</td> <td>The maximum of the mark for the X axis; 32-bit integer number</td> </tr> <tr> <td>4,5</td> <td>The minimum of the mark for the Y axis; 32-bit integer number</td> </tr> <tr> <td>6,7</td> <td>The maximum of the mark for the Y axis; 32-bit integer number</td> </tr> <tr> <td>8,9</td> <td>The minimum of X values for pen #1; 32-bit integer number, 32-bit unsigned integer number, or 32-bit floating point number</td> </tr> <tr> <td>10,11</td> <td>The maximum of X values for pen #1; (Same as above)</td> </tr> <tr> <td>12,13</td> <td>The minimum of Y values for pen #1; (Same as above)</td> </tr> <tr> <td>14,15</td> <td>The maximum of Y values for pen #1; (Same as above)</td> </tr> <tr> <td>...</td> <td>...</td> </tr> <tr> <td>64,65</td> <td>The minimum of X values for pen #8; (Same as above)</td> </tr> <tr> <td>66,67</td> <td>The maximum of X values for pen #8; (Same as above)</td> </tr> <tr> <td>68,69</td> <td>The minimum of Y values for pen #8; (Same as above)</td> </tr> <tr> <td>70,71</td> <td>The maximum of Y values for pen #8; (Same as above)</td> </tr> </tbody> </table>	Word	Description	0,1	The minimum of the mark for the X axis; 32-bit integer number	2,3	The maximum of the mark for the X axis; 32-bit integer number	4,5	The minimum of the mark for the Y axis; 32-bit integer number	6,7	The maximum of the mark for the Y axis; 32-bit integer number	8	The minimum of X values for pen #1; 16-bit integer number or 16-bit unsigned integer number	9	The maximum of X values for pen #1; (Same as above)	10	The minimum of Y values for pen #1; (Same as above)	11	The maximum of Y values for pen #1; (Same as above)	12	The minimum of X values for pen #2; (Same as above)	13	The maximum of X values for pen #2; (Same as above)	38	The minimum of Y values for pen #8; (Same as above)	39	The maximum of Y values for pen #8; (Same as above)	Word	Description	0,1	The minimum of the mark for the X axis; 32-bit integer number	2,3	The maximum of the mark for the X axis; 32-bit integer number	4,5	The minimum of the mark for the Y axis; 32-bit integer number	6,7	The maximum of the mark for the Y axis; 32-bit integer number	8,9	The minimum of X values for pen #1; 32-bit integer number, 32-bit unsigned integer number, or 32-bit floating point number	10,11	The maximum of X values for pen #1; (Same as above)	12,13	The minimum of Y values for pen #1; (Same as above)	14,15	The maximum of Y values for pen #1; (Same as above)	64,65	The minimum of X values for pen #8; (Same as above)	66,67	The maximum of X values for pen #8; (Same as above)	68,69	The minimum of Y values for pen #8; (Same as above)	70,71
Word	Description																																																								
0,1	The minimum of the mark for the X axis; 32-bit integer number																																																								
2,3	The maximum of the mark for the X axis; 32-bit integer number																																																								
4,5	The minimum of the mark for the Y axis; 32-bit integer number																																																								
6,7	The maximum of the mark for the Y axis; 32-bit integer number																																																								
8	The minimum of X values for pen #1; 16-bit integer number or 16-bit unsigned integer number																																																								
9	The maximum of X values for pen #1; (Same as above)																																																								
10	The minimum of Y values for pen #1; (Same as above)																																																								
11	The maximum of Y values for pen #1; (Same as above)																																																								
12	The minimum of X values for pen #2; (Same as above)																																																								
13	The maximum of X values for pen #2; (Same as above)																																																								
...	...																																																								
38	The minimum of Y values for pen #8; (Same as above)																																																								
39	The maximum of Y values for pen #8; (Same as above)																																																								
Word	Description																																																								
0,1	The minimum of the mark for the X axis; 32-bit integer number																																																								
2,3	The maximum of the mark for the X axis; 32-bit integer number																																																								
4,5	The minimum of the mark for the Y axis; 32-bit integer number																																																								
6,7	The maximum of the mark for the Y axis; 32-bit integer number																																																								
8,9	The minimum of X values for pen #1; 32-bit integer number, 32-bit unsigned integer number, or 32-bit floating point number																																																								
10,11	The maximum of X values for pen #1; (Same as above)																																																								
12,13	The minimum of Y values for pen #1; (Same as above)																																																								
14,15	The maximum of Y values for pen #1; (Same as above)																																																								
...	...																																																								
64,65	The minimum of X values for pen #8; (Same as above)																																																								
66,67	The maximum of X values for pen #8; (Same as above)																																																								
68,69	The minimum of Y values for pen #8; (Same as above)																																																								
70,71	The maximum of Y values for pen #8; (Same as above)																																																								

8.5.5. Pen Settings

This section describes how to define the pens for the scatter charts. The following is an example of the Pen page.

The screenshot shows the 'Pen' tab of a settings dialog. It contains three columns for Pen #1, Pen #2, and Pen #3. Each column has a 'Dynamic Range' checkbox, four input fields for 'X Min.', 'X Max.', 'Y Min.', and 'Y Max.', a 'Mark Size' spinner set to 2, a 'Line' style selector, and a 'Color' selector. Pen #1 is blue, Pen #2 is green, and Pen #3 is cyan. Pen #3 has its 'Dynamic Range' checkbox checked.

The following table describes each property in the Pen page. Note that pen #1 is for data set 1; pen #2 is for data set 2; and so on.

Property		Description
Pen #1 to Pen #8	Dynamic Range	Check this option so the minimum and maximum for the X and Y values of the associated data set will be specified at runtime. This option is available when the Dynamic Range option in the General page is selected.
	X Min.	The X minimum of the associated data set. This property is available when the Dynamic Range option is not selected.
	X Max.	The X maximum of the data value of the associated data set. This property is available when the Dynamic Range option is not selected.
	Y Min.	The Y minimum of the associated data set. This property is available when the Dynamic Range option is not selected.
	Y Max.	The Y minimum of the associated data set. This property is available when the Dynamic Range option is not selected.
	Mark Size	Select a size for the data point mark. The selection is valid when the Show Mark option in the General page is selected.
	Line Style	Select a style for the connecting lines. The selection is valid when the Show Line option in the General page is selected.
	Color	Select a color for the connecting lines.

CHAPTER 9

ANIMATED OBJECTS

9.1. Pipelines	1
9.1.1. Basic Operations.....	1
9.1.2. Operation Options.....	3
9.1.3. Settings	3
9.1.4. General Settings.....	3
9.1.5. Pipe Settings	6
9.2. Dynamic Circles	7
9.2.1. Operation Options.....	7
9.2.2. Settings	7
9.2.3. General Settings.....	8
9.2.4. Specifying Colors for Dynamic Rectangles and Circles	10
9.3. Dynamic Rectangles	12
9.3.1. Operation Options.....	12
9.3.2. Settings	12
9.3.3. General Settings.....	13
9.4. GIF Displays	16
9.4.1. Operation Options.....	16
9.4.2. Settings	16
9.4.3. General Settings.....	17
9.5. Picture Displays	19
9.5.1. Basic Operations.....	19
9.5.2. Operation Options.....	19
9.5.3. Settings	19
9.5.4. General Settings.....	20
9.6. Animated Graphics	21
9.6.1. Operation Options.....	21
9.6.2. Settings	21
9.6.3. General Settings.....	22
9.6.4. GIF Settings	29
9.6.5. Path Settings	30

9.1. Pipelines

9.1.1. Basic Operations

A pipeline is composed of L/T/Cross connectors and pipes. With the software, you can create a pipeline easily and efficiently. You can also control a pipeline to change color, blink, and/or show the flow effect dynamically at runtime.

The following is a sample of a pipeline with the flow effect:

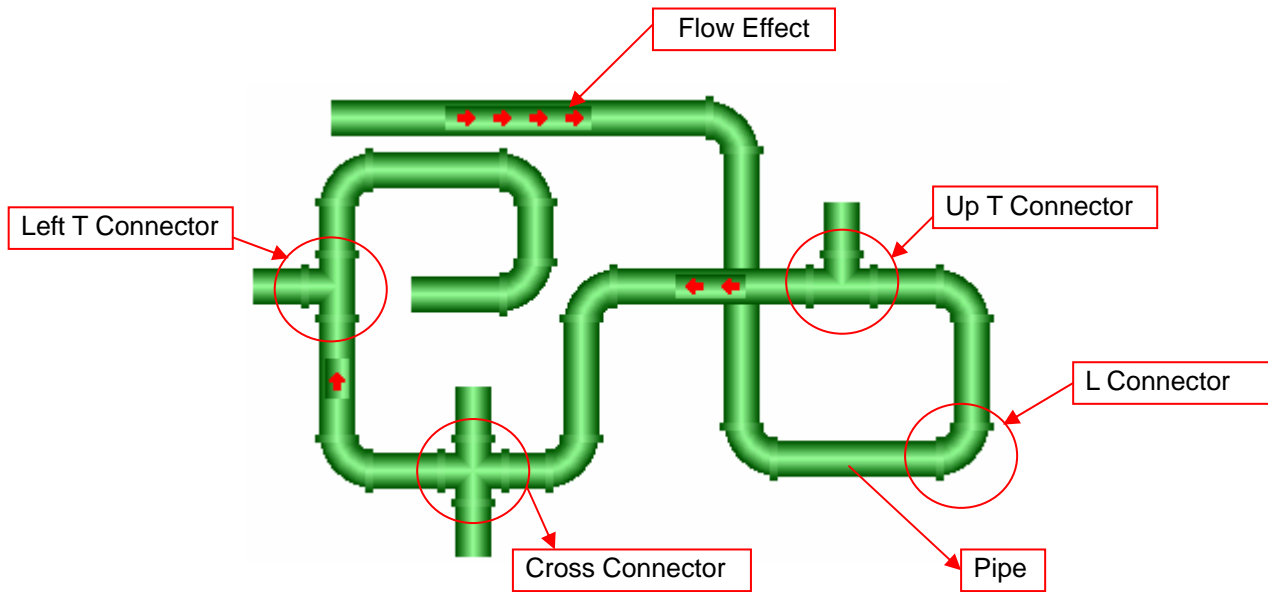



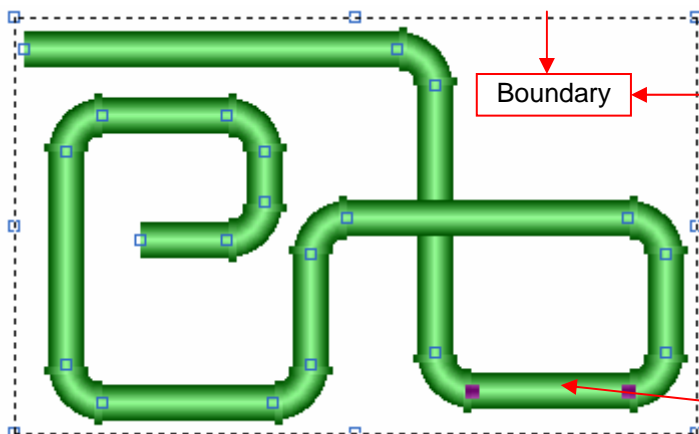

To draw a pipeline, you need to do the following:

1. In the Object menu or Object toolbar, click Pipeline  to draw a pipeline.
2. Move the cursor onto the screen where you want to draw a pipeline and click the position for the start point of the pipeline.
3. Continue clicking on the screen to place as many L connectors needed for the pipes in the pipeline.
4. Right-click to complete the pipeline.
5. Drag one blue handle on the boundary of the pipeline at a time to resize the pipeline.
6. Drag one blue or black handle on the pipeline at a time to adjust the position and length of the selected pipe of the pipeline. The pipe or connector with black handles represents the selected pipe or connector.



The picture on the left shows the handles of a pipeline. The blue handles on the boundary of the pipeline are for resizing the entire pipeline. The blue or black handles on the pipeline are for moving the vertices of the selected pipe.

Position the mouse pointer over one of the handles. When the cursor changes to  or  or  or , drag the handle until the pipeline is the shape and size you want.

7. Right-click anywhere on the pipeline and use the Insert Connector command on the object pop-up menu to insert a new T/ Cross connector to the pipeline. Alternatively, right-click the existing connector or pipe of the pipeline and use the Delete Pipe Segment command on the object pop-up menu to delete the connector and its connected pipe.

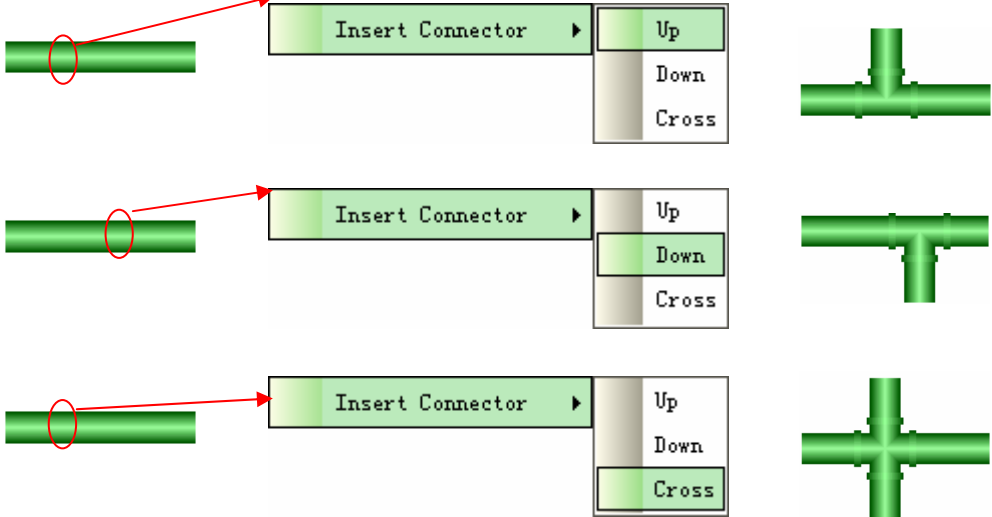
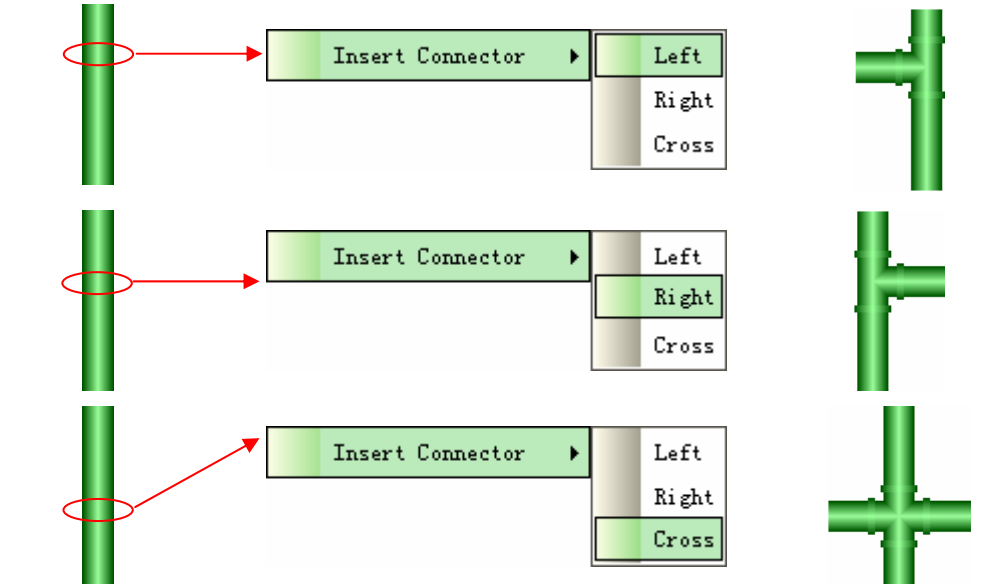
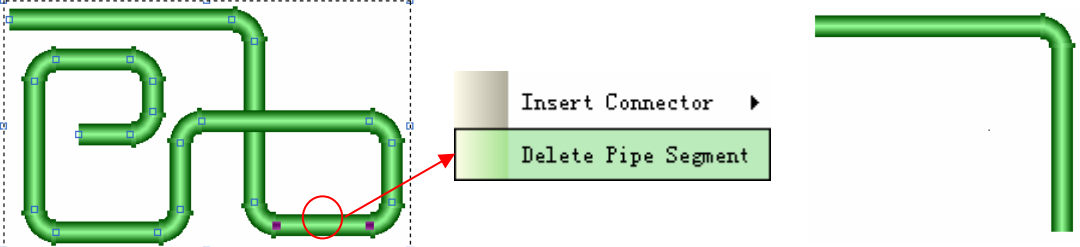
Pop-up menu	Description
Insert Connector	<p>Add an Up/Down T or Cross connector to the specified position on the horizontal pipe.</p>  <p>Add a Left/Right T or Cross connector to the specified position on the vertical pipe</p> 
Delete Pipe Segment	<p>Delete a selected pipe segment and its successor.</p> 

9.1.2. Operation Options

The following operation option can be added to a pipeline. Select and set up the option in the Pipeline property sheet.

Options	Description
Visibility Control	You can show and hide a pipeline by a specified bit or the current user level. Select and set up this option in the Visibility page.

9.1.3. Settings

You can complete all the settings of a pipeline in the Pipeline property sheet. This sheet contains the following three pages.

- **General**

Described in [Section 9.1.4.](#)

- **Pipe**

Described in [Section 9.1.5.](#)

- **Visibility**







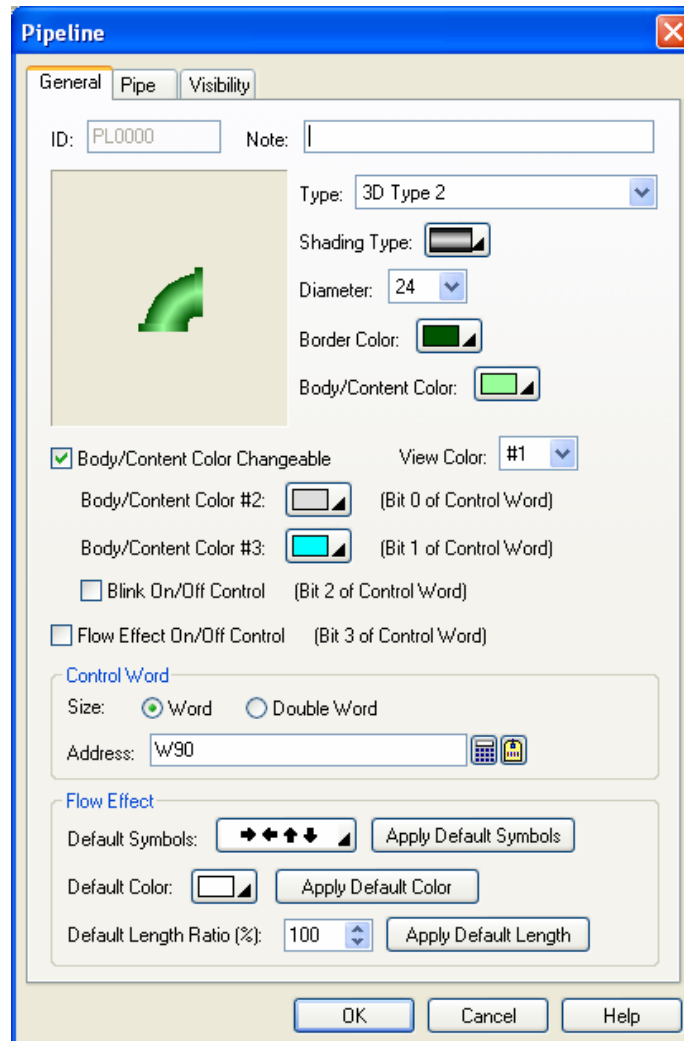



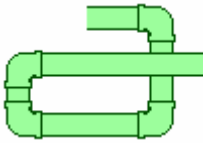
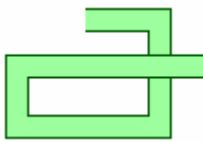

Described in [Section 4.4.6.](#)

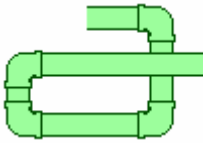
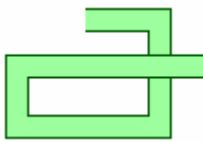
9.1.4. General Settings



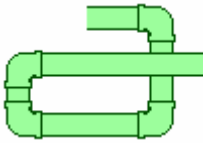
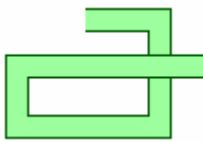



This section describes how to define the general settings for the pipelines. The following is an example of the General page of the Pipeline property sheet.



The following table describes each property in the General page.

Property	Description												
ID	The object's identifier. It is generated when the object is created. The identifier is unique within the screen where the object is located. The format of the IDs for the pipelines is PLnnnn.												
Note	You can type a note for the object.												
Type	The type of the pipeline. There are five types available: <table border="1" data-bbox="512 461 1099 1290"> <thead> <tr> <th>Type</th> <th>Example</th> </tr> </thead> <tbody> <tr> <td>2D Type 1</td> <td></td> </tr> <tr> <td>2D Type 2</td> <td></td> </tr> <tr> <td>2D Type 3</td> <td></td> </tr> <tr> <td>3D Type 1</td> <td></td> </tr> <tr> <td>3D Type 2</td> <td></td> </tr> </tbody> </table>	Type	Example	2D Type 1		2D Type 2		2D Type 3		3D Type 1		3D Type 2	
Type	Example												
2D Type 1													
2D Type 2													
2D Type 3													
3D Type 1													
3D Type 2													
Shading	Select a shading method when the Type is "3D Type 1" or "3D Type 2". There are three shading methods available: 												
Diameter	Specifies the diameter of the pipeline.												
Border Color	Specifies the border color of the pipeline.												
Body/Content Color	Specifies the body or content color of the pipeline.												
Flow Effect On/Off Control	Check this option if you want to enable or disable the flow effect for the pipeline at runtime. The flow effect will be enabled when bit 3 of the control word is on.												

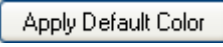
Continued

Property		Description									
Body/Content Color Changeable	<Check Box>	Check this option if you want to control the body/content color of the pipeline at runtime. The variable that controls the pipeline is called the control word and is specified in the Address field.									
	View Color	Select a color so you can view the pipeline painted with that color. <table border="1" data-bbox="512 376 1267 551"> <thead> <tr> <th>View Color</th> <th>Painted With</th> </tr> </thead> <tbody> <tr> <td>0</td> <td>Body/Content Color</td> </tr> <tr> <td>1</td> <td>Body/Content Color #2</td> </tr> <tr> <td>2</td> <td>Body/Content Color #3</td> </tr> </tbody> </table>	View Color	Painted With	0	Body/Content Color	1	Body/Content Color #2	2	Body/Content Color #3	
	View Color	Painted With									
	0	Body/Content Color									
	1	Body/Content Color #2									
	2	Body/Content Color #3									
Body/Content Color #2	Select a color as the second body/content color for the pipeline. This color will be used to paint the pipeline when bit 0 of the control word is on.										
Body/Content Color #3	Select a color as the third body/content color for the pipeline. This color will be used to paint the pipeline when bit 1 of the control word is on.										
Blink On/Off Control	Check this option if you want the pipeline to blink at runtime. The pipeline will blink when bit 2 of the control word is on.										
Control Word	Size	Select Word or Double Word for the size of the control word.									
	Address	Specifies the variable that controls the pipeline. Click  to enter an address for this field. Click  to select a tag for this field. The following table shows the bit assignment data of the variable: <table border="1" data-bbox="512 965 1318 1178"> <thead> <tr> <th>Bit</th> <th>Assignment</th> </tr> </thead> <tbody> <tr> <td>0</td> <td>Shows body/content color #2 when this bit is on</td> </tr> <tr> <td>1</td> <td>Shows body/content color #3 when this bit is on</td> </tr> <tr> <td>2</td> <td>Blinks when this bit is on</td> </tr> <tr> <td>3</td> <td>Shows the flow effect when this bit is on</td> </tr> </tbody> </table>	Bit	Assignment	0	Shows body/content color #2 when this bit is on	1	Shows body/content color #3 when this bit is on	2	Blinks when this bit is on	3
Bit	Assignment										
0	Shows body/content color #2 when this bit is on										
1	Shows body/content color #3 when this bit is on										
2	Blinks when this bit is on										
3	Shows the flow effect when this bit is on										
Flow Effect	Default Symbols	Select a set of symbols as the default symbols for the flow effect. There are 14 available sets: <div data-bbox="517 1285 619 1684" style="border: 1px solid black; padding: 5px; margin: 10px 0;">  </div> Click  to make all pipes of the pipeline use the default symbols for the flow effect.									
	Default Color	Select a color as the default color for the flow symbols. Click  to make all pipes of the pipeline use the default color for the flow symbols.									
	Default Length Ratio(%)	Specifies the length ratio between pipe and flow effect as the default length ratio. Click  to make all pipes of the pipeline use the default length ratio for the flow effect.									

9.1.5. Pipe Settings

This section describes how to define the pipes for the pipelines. The following is an example of the Pipe page.

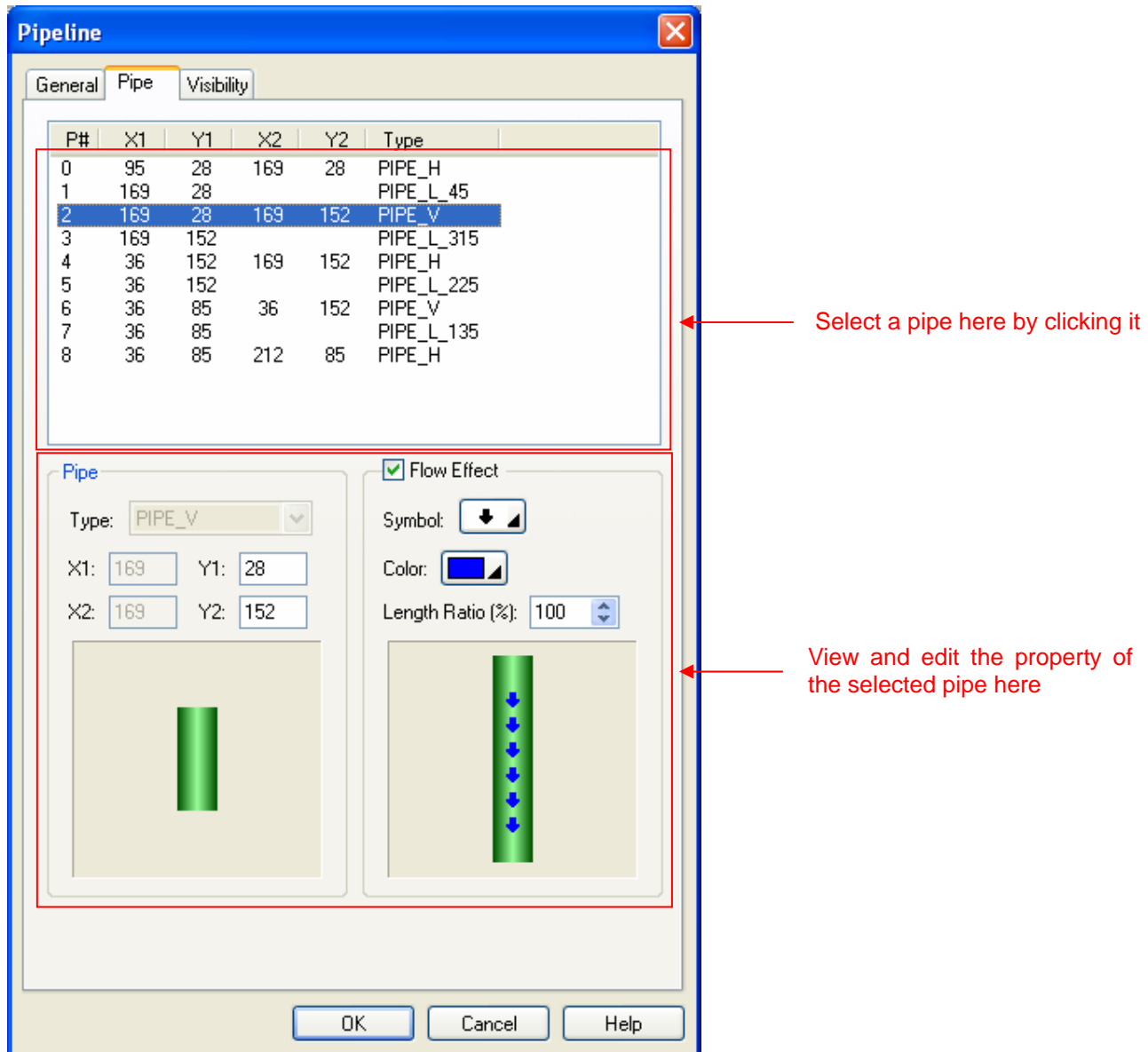

The following table describes each property in the Pipe page.

Property		Description
Pipe	Type	Specifies the type of the selected pipe.
	X1	The horizontal coordinate of the upper-left corner of the selected pipe.
	Y1	The vertical coordinate of the upper-left corner of the selected pipe.
	X2	The horizontal coordinate of the lower-right corner of the selected pipe.
	Y2	The vertical coordinate of the lower-right corner of the selected pipe.
Flow Effect	<Check Box>	Select this option if you want the selected pipe to show the flow effect.
	Symbol	Select a symbol for the flow effect.
	Color	Select a color for the flow symbol
	Length Ratio(%)	Specifies the length ratio between pipe and flow effect.

9.2. Dynamic Circles

You can change the size, position, and/or color of a dynamic circle at runtime.

9.2.1. Operation Options

The following operation option can be added to a dynamic circle. Select and set up the option in the Dynamic Circle property sheet.

Options	Description
Visibility Control	You can show and hide a dynamic circle by a specified bit or the current user level. Select and set up this option in the Visibility page.

9.2.2. Settings

You can complete all the settings of a dynamic circle in the Dynamic Circle property sheet. This sheet contains the following two pages.

- **General**

Described in [Section 9.2.3.](#)

- **Visibility**

Described in [Section 4.4.6.](#)

9.2.3. General Settings

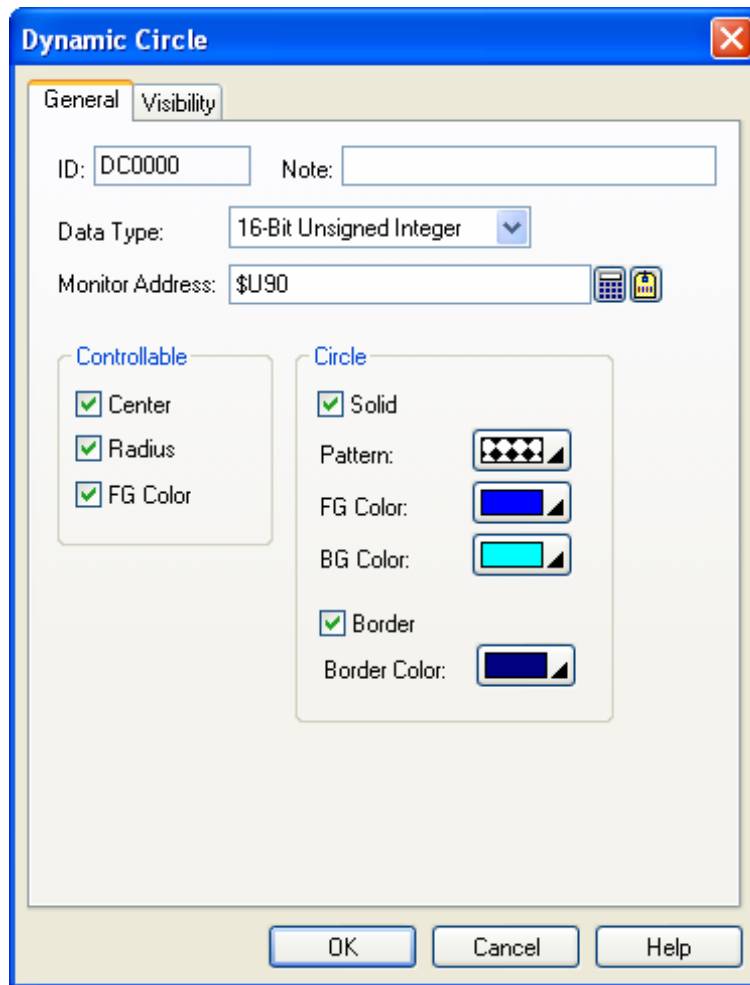

This section describes how to define the general settings for dynamic circles. The following is an example of the General page of the Dynamic Circle property sheet.



The following table describes each property in the General page.

Property	Description
ID	The object's identifier. It is generated when the object is created. The identifier is unique within the screen where the object is located. The format of the IDs for the dynamic circles is DCnnnn.
Note	You can type a note for the object.
Data Type	The data type of the variable that controls the dynamic circle. The supported data types include: 16-Bit Unsigned Integer, 32-Bit Unsigned Integer, 16-Bit Signed Integer, 32-Bit Signed Integer, 16-Bit BCD, and 32-Bit BCD.

Continued

Property		Description																									
Monitor Address		<p>Specifies the variable that controls the dynamic circle.</p> <p>Click  to enter an address for this field. Click  to select a tag for this field.</p> <p>The following table shows the data arrangement of the variable.</p> <table border="1"> <thead> <tr> <th>Data Type</th> <th>16-Bit Unsigned Int. 16-Bit Signed Int. 16-Bit BCD</th> <th>32-Bit Unsigned Int. 32-Bit Signed Int. 32-Bit BCD</th> </tr> </thead> <tbody> <tr> <td> <input type="checkbox"/> Center <input type="checkbox"/> Radius <input checked="" type="checkbox"/> FG Color </td> <td>W0 <input type="text" value="FG Color"/></td> <td>W0,1 <input type="text" value="FG Color"/></td> </tr> <tr> <td> <input type="checkbox"/> Center <input checked="" type="checkbox"/> Radius <input type="checkbox"/> FG Color </td> <td>W0 <input type="text" value="Radius"/></td> <td>W0,1 <input type="text" value="Radius"/></td> </tr> <tr> <td> <input type="checkbox"/> Center <input checked="" type="checkbox"/> Radius <input checked="" type="checkbox"/> FG Color </td> <td>W0 <input type="text" value="Radius"/> W1 <input type="text" value="FG Color"/></td> <td>W0,1 <input type="text" value="Radius"/> W2,3 <input type="text" value="FG Color"/></td> </tr> <tr> <td> <input checked="" type="checkbox"/> Center <input type="checkbox"/> Radius <input type="checkbox"/> FG Color </td> <td>W0 <input type="text" value="X"/> W1 <input type="text" value="Y"/></td> <td>W0,1 <input type="text" value="X"/> W2,3 <input type="text" value="Y"/></td> </tr> <tr> <td> <input checked="" type="checkbox"/> Center <input type="checkbox"/> Radius <input checked="" type="checkbox"/> FG Color </td> <td>W0 <input type="text" value="X"/> W1 <input type="text" value="Y"/> W2 <input type="text" value="FG Color"/></td> <td>W0,1 <input type="text" value="X"/> W2,3 <input type="text" value="Y"/> W4,5 <input type="text" value="FG Color"/></td> </tr> <tr> <td> <input checked="" type="checkbox"/> Center <input checked="" type="checkbox"/> Radius <input type="checkbox"/> FG Color </td> <td>W0 <input type="text" value="X"/> W1 <input type="text" value="Y"/> W2 <input type="text" value="Radius"/></td> <td>W0,1 <input type="text" value="X"/> W2,3 <input type="text" value="Y"/> W4,5 <input type="text" value="Radius"/></td> </tr> <tr> <td> <input checked="" type="checkbox"/> Center <input checked="" type="checkbox"/> Radius <input checked="" type="checkbox"/> FG Color </td> <td>W0 <input type="text" value="X"/> W1 <input type="text" value="Y"/> W2 <input type="text" value="Radius"/> W3 <input type="text" value="FG Color"/></td> <td>W0,1 <input type="text" value="X"/> W2,3 <input type="text" value="Y"/> W4,5 <input type="text" value="Radius"/> W6,7 <input type="text" value="FG Color"/></td> </tr> </tbody> </table> <p>Note: About color values, see Section 9.2.4.</p>		Data Type	16-Bit Unsigned Int. 16-Bit Signed Int. 16-Bit BCD	32-Bit Unsigned Int. 32-Bit Signed Int. 32-Bit BCD	<input type="checkbox"/> Center <input type="checkbox"/> Radius <input checked="" type="checkbox"/> FG Color	W0 <input type="text" value="FG Color"/>	W0,1 <input type="text" value="FG Color"/>	<input type="checkbox"/> Center <input checked="" type="checkbox"/> Radius <input type="checkbox"/> FG Color	W0 <input type="text" value="Radius"/>	W0,1 <input type="text" value="Radius"/>	<input type="checkbox"/> Center <input checked="" type="checkbox"/> Radius <input checked="" type="checkbox"/> FG Color	W0 <input type="text" value="Radius"/> W1 <input type="text" value="FG Color"/>	W0,1 <input type="text" value="Radius"/> W2,3 <input type="text" value="FG Color"/>	<input checked="" type="checkbox"/> Center <input type="checkbox"/> Radius <input type="checkbox"/> FG Color	W0 <input type="text" value="X"/> W1 <input type="text" value="Y"/>	W0,1 <input type="text" value="X"/> W2,3 <input type="text" value="Y"/>	<input checked="" type="checkbox"/> Center <input type="checkbox"/> Radius <input checked="" type="checkbox"/> FG Color	W0 <input type="text" value="X"/> W1 <input type="text" value="Y"/> W2 <input type="text" value="FG Color"/>	W0,1 <input type="text" value="X"/> W2,3 <input type="text" value="Y"/> W4,5 <input type="text" value="FG Color"/>	<input checked="" type="checkbox"/> Center <input checked="" type="checkbox"/> Radius <input type="checkbox"/> FG Color	W0 <input type="text" value="X"/> W1 <input type="text" value="Y"/> W2 <input type="text" value="Radius"/>	W0,1 <input type="text" value="X"/> W2,3 <input type="text" value="Y"/> W4,5 <input type="text" value="Radius"/>	<input checked="" type="checkbox"/> Center <input checked="" type="checkbox"/> Radius <input checked="" type="checkbox"/> FG Color	W0 <input type="text" value="X"/> W1 <input type="text" value="Y"/> W2 <input type="text" value="Radius"/> W3 <input type="text" value="FG Color"/>	W0,1 <input type="text" value="X"/> W2,3 <input type="text" value="Y"/> W4,5 <input type="text" value="Radius"/> W6,7 <input type="text" value="FG Color"/>
Data Type	16-Bit Unsigned Int. 16-Bit Signed Int. 16-Bit BCD	32-Bit Unsigned Int. 32-Bit Signed Int. 32-Bit BCD																									
<input type="checkbox"/> Center <input type="checkbox"/> Radius <input checked="" type="checkbox"/> FG Color	W0 <input type="text" value="FG Color"/>	W0,1 <input type="text" value="FG Color"/>																									
<input type="checkbox"/> Center <input checked="" type="checkbox"/> Radius <input type="checkbox"/> FG Color	W0 <input type="text" value="Radius"/>	W0,1 <input type="text" value="Radius"/>																									
<input type="checkbox"/> Center <input checked="" type="checkbox"/> Radius <input checked="" type="checkbox"/> FG Color	W0 <input type="text" value="Radius"/> W1 <input type="text" value="FG Color"/>	W0,1 <input type="text" value="Radius"/> W2,3 <input type="text" value="FG Color"/>																									
<input checked="" type="checkbox"/> Center <input type="checkbox"/> Radius <input type="checkbox"/> FG Color	W0 <input type="text" value="X"/> W1 <input type="text" value="Y"/>	W0,1 <input type="text" value="X"/> W2,3 <input type="text" value="Y"/>																									
<input checked="" type="checkbox"/> Center <input type="checkbox"/> Radius <input checked="" type="checkbox"/> FG Color	W0 <input type="text" value="X"/> W1 <input type="text" value="Y"/> W2 <input type="text" value="FG Color"/>	W0,1 <input type="text" value="X"/> W2,3 <input type="text" value="Y"/> W4,5 <input type="text" value="FG Color"/>																									
<input checked="" type="checkbox"/> Center <input checked="" type="checkbox"/> Radius <input type="checkbox"/> FG Color	W0 <input type="text" value="X"/> W1 <input type="text" value="Y"/> W2 <input type="text" value="Radius"/>	W0,1 <input type="text" value="X"/> W2,3 <input type="text" value="Y"/> W4,5 <input type="text" value="Radius"/>																									
<input checked="" type="checkbox"/> Center <input checked="" type="checkbox"/> Radius <input checked="" type="checkbox"/> FG Color	W0 <input type="text" value="X"/> W1 <input type="text" value="Y"/> W2 <input type="text" value="Radius"/> W3 <input type="text" value="FG Color"/>	W0,1 <input type="text" value="X"/> W2,3 <input type="text" value="Y"/> W4,5 <input type="text" value="Radius"/> W6,7 <input type="text" value="FG Color"/>																									
Controllable		Center	Check this option if you want to control the center.																								
		Radius	Check this option if you want to control the radius.																								
		FG Color	Check this option if you want to control the FG color. This option is available when the Circle is Solid and the Pattern is not solid white.																								
Circle	Solid	<Check Box>	Check this option if you want the dynamic circle to be filled with the selected pattern.																								
		Pattern	Select a pattern for filling the dynamic circle.																								
		FG Color	Select a color to paint the black part of the pattern. This item is available when the Pattern is not solid white.																								
		BG Color	Select a color to paint the white part of the pattern.																								
	Border	<Check Box>	Check this option if you want the dynamic circle to have a border.																								
		Border Color	The border color.																								

9.2.4. Specifying Colors for Dynamic Rectangles and Circles

9.2.4.1. 64K-color Models

64K-color HMI models use one word to specify a color. The color word contains the three color components: red, green, and blue. The format to store the three color components of a color is described below.

Bit 0-4: 5 bits to store the blue component

Bit 5-10: 6 bits to store the green component

Bit 11-15: 5 bits to store the red component

Example

Color	Red	Green	Blue	Hex. Value	Decimal Value
Black	0	0	0	0000H	0
Blue	0	0	16	0010H	16
Green	0	32	0	0400H	1024
Cyan	0	32	16	0410H	1040
Red	16	0	0	8000H	32768
Magenta	16	0	16	8010H	32784
Brown	16	32	0	8400H	33792
Dark gray	16	32	16	8410H	33808
Gray	24	48	24	C618H	50712
Light blue	0	0	31	001FH	31
Light green	0	63	0	07E0H	2016
Light cyan	0	63	31	07FFH	2047
Light red	31	0	0	F800H	63488
Light magenta	31	0	31	F81FH	63519
Yellow	31	63	0	FFE0H	65504
White	31	63	31	FFFFH	65535

9.2.4.2. 256-color Models

The following table lists the color index values used by 256-color HMI models. You can use the color index values to specify the desired colors for your application.

Color Index Value	Color	Color Index Value	Color	Color Index Value	Color
0	Black	84	Autumn Orange	159	Chalk
1	Blue; 53% Blue	85	Light Orange	166	Deep Blue
2	Red; 53% Red	88	Deep Navy Blue	172	Deep River
3	Green; 53% Green	91	Grass Green	174	Twilight Blue
4	Magenta; 53% Magenta	94	Deep Purple	177	Turquoise
5	Cyan; 53% Cyan	96	Moss Green	178	Purple
6	Brown; 53% Yellow	97	Kentucky Green	179	Majestic Purple
7	Light blue	103	Army Green	180	Twilight Violet
8	Gray; 50% Black	107	Crimson	182	Light Blue Green
9	Light red	109	Khaki	186	Violet
10	Light green	110	Dull Green	187	Pale Purple
11	Light magenta	113	Regal red	189	Ghost Green
12	Light gray; 20% Black	117	Moon Green	193	Pink
13	Light cyan	118	Neon Red	194	Faded Pink
14	Yellow	120	Tropical Pink	195	Pale Yellow
15	White	121	Peach	200	Sky Blue
23	Murky Green	123	Light Yellow	209	Deep Azure
29	Walnut	125	Navy Blue	210	Electric Blue
34	Ruby red	130	Storm Blue	211	Baby Blue
39	Chartreuse	132	Desert Blue	214	Blue Purple
41	Brick Red	134	Sea Green	216	Blue Violet
48	Orange	137	Grape	217	Pastel Blue
50	Deep Yellow	139	Ocean Green	219	Ice Blue
54	Forest Green	142	Deep Violet	221	Neon Purple
62	Spring Green	144	Dusty Plum	222	Light Purple
65	Dark Brown	146	Faded Green	223	Easter Purple
66	Olive Drab	147	Mint Green	224	Powder Blue
67	Avocado Green	149	Deep Rose	229	Light Violet
73	Olive	150	Dusty Rose		
74	Martian Green	155	Hot Pink		
78	Red Brown	156	Deep Pink		
79	Gold	157	Soft Pink		
80	Banana Yellow	158	Sand		

9.3. Dynamic Rectangles

You can change the size, position, and/or color of a dynamic rectangle at runtime.

9.3.1. Operation Options

The following operation option can be added to a dynamic rectangle. Select and set up the option in the Dynamic Rectangle property sheet.

Options	Description
Visibility Control	You can show and hide a dynamic rectangle by a specified bit or the current user level. Select and set up this option in the Visibility page.

9.3.2. Settings

You can complete all the settings of a dynamic rectangle in the Dynamic Rectangle property sheet. This sheet contains the following two pages.

- **General**

Described in [Section 9.3.3.](#)

- **Visibility**

Described in [Section 4.4.6.](#)

9.3.3. General Settings

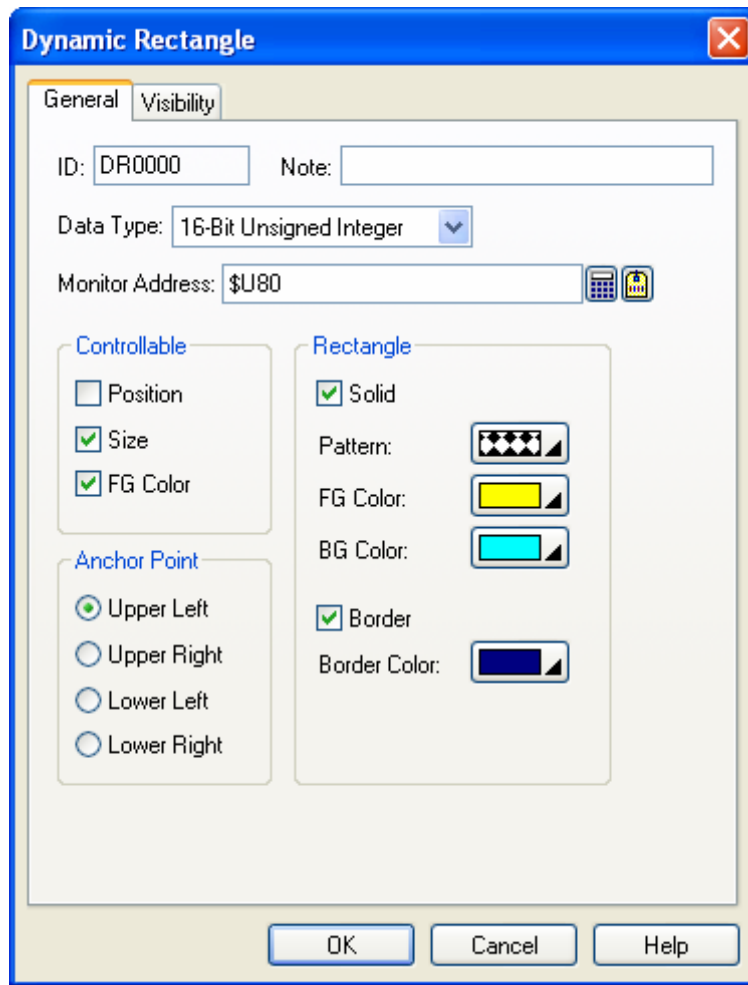

This section describes how to define the general settings for dynamic rectangles. The following is an example of the General page of the Dynamic Rectangle property sheet.



The following table describes each property in the General page.

Property	Description
ID	The object's identifier. It is generated when the object is created. The identifier is unique within the screen where the object is located. The format of the IDs for the dynamic rectangles is DRnnnn.
Note	You can type a note for the object.
Data Type	The data type of the variable that controls the dynamic rectangle. The supported data types include: 16-Bit Unsigned Integer, 32-Bit Unsigned Integer, 16-Bit Signed Integer, 32-Bit Signed Integer, 16-Bit BCD, and 32-Bit BCD.

Continued

Property		Description																								
Monitor Address		<p>Specifies the variable that controls the dynamic rectangle.</p> <p>Click  to enter an address for this field. Click  to select a tag for this field.</p> <p>The following table shows the data arrangement of the monitored variable.</p> <table border="1"> <thead> <tr> <th>Data Type</th> <th>16-Bit Unsigned Int. 16-Bit Signed Int. 16-Bit BCD</th> <th>32-Bit Unsigned Int. 32-Bit Signed Int. 32-Bit BCD</th> </tr> </thead> <tbody> <tr> <td> <input type="checkbox"/> Position <input type="checkbox"/> Size <input checked="" type="checkbox"/> FG Color </td> <td>W0 <input type="text" value="FG Color"/></td> <td>W0,1 <input type="text" value="FG Color"/></td> </tr> <tr> <td> <input type="checkbox"/> Position <input checked="" type="checkbox"/> Size <input type="checkbox"/> FG Color </td> <td> W0 <input type="text" value="Width"/> W1 <input type="text" value="Height"/> </td> <td> W0,1 <input type="text" value="Width"/> W2,3 <input type="text" value="Height"/> </td> </tr> <tr> <td> <input type="checkbox"/> Position <input checked="" type="checkbox"/> Size <input checked="" type="checkbox"/> FG Color </td> <td> W0 <input type="text" value="Width"/> W1 <input type="text" value="Height"/> W2 <input type="text" value="FG Color"/> </td> <td> W0,1 <input type="text" value="Width"/> W2,3 <input type="text" value="Height"/> W4,5 <input type="text" value="FG Color"/> </td> </tr> <tr> <td> <input checked="" type="checkbox"/> Position <input type="checkbox"/> Size <input type="checkbox"/> FG Color </td> <td> W0 <input type="text" value="X"/> W1 <input type="text" value="Y"/> </td> <td> W0,1 <input type="text" value="X"/> W2,3 <input type="text" value="Y"/> </td> </tr> <tr> <td> <input checked="" type="checkbox"/> Position <input type="checkbox"/> Size <input checked="" type="checkbox"/> FG Color </td> <td> W0 <input type="text" value="X"/> W1 <input type="text" value="Y"/> W2 <input type="text" value="FG Color"/> </td> <td> W0,1 <input type="text" value="X"/> W2,3 <input type="text" value="Y"/> W4,5 <input type="text" value="FG Color"/> </td> </tr> <tr> <td> <input checked="" type="checkbox"/> Position <input checked="" type="checkbox"/> Size <input type="checkbox"/> FG Color </td> <td> W0 <input type="text" value="X"/> W1 <input type="text" value="Y"/> W2 <input type="text" value="Width"/> W3 <input type="text" value="Height"/> </td> <td> W0,1 <input type="text" value="X"/> W2,3 <input type="text" value="Y"/> W4,5 <input type="text" value="Width"/> W6,7 <input type="text" value="Height"/> </td> </tr> <tr> <td> <input checked="" type="checkbox"/> Position <input checked="" type="checkbox"/> Size <input checked="" type="checkbox"/> FG Color </td> <td> W0 <input type="text" value="X"/> W1 <input type="text" value="Y"/> W2 <input type="text" value="Width"/> W3 <input type="text" value="Height"/> W4 <input type="text" value="FG Color"/> </td> <td> W0,1 <input type="text" value="X"/> W2,3 <input type="text" value="Y"/> W4,5 <input type="text" value="Width"/> W6,7 <input type="text" value="Height"/> W8,9 <input type="text" value="FG Color"/> </td> </tr> </tbody> </table> <p>Note: About color values, see Section 9.2.4.</p>	Data Type	16-Bit Unsigned Int. 16-Bit Signed Int. 16-Bit BCD	32-Bit Unsigned Int. 32-Bit Signed Int. 32-Bit BCD	<input type="checkbox"/> Position <input type="checkbox"/> Size <input checked="" type="checkbox"/> FG Color	W0 <input type="text" value="FG Color"/>	W0,1 <input type="text" value="FG Color"/>	<input type="checkbox"/> Position <input checked="" type="checkbox"/> Size <input type="checkbox"/> FG Color	W0 <input type="text" value="Width"/> W1 <input type="text" value="Height"/>	W0,1 <input type="text" value="Width"/> W2,3 <input type="text" value="Height"/>	<input type="checkbox"/> Position <input checked="" type="checkbox"/> Size <input checked="" type="checkbox"/> FG Color	W0 <input type="text" value="Width"/> W1 <input type="text" value="Height"/> W2 <input type="text" value="FG Color"/>	W0,1 <input type="text" value="Width"/> W2,3 <input type="text" value="Height"/> W4,5 <input type="text" value="FG Color"/>	<input checked="" type="checkbox"/> Position <input type="checkbox"/> Size <input type="checkbox"/> FG Color	W0 <input type="text" value="X"/> W1 <input type="text" value="Y"/>	W0,1 <input type="text" value="X"/> W2,3 <input type="text" value="Y"/>	<input checked="" type="checkbox"/> Position <input type="checkbox"/> Size <input checked="" type="checkbox"/> FG Color	W0 <input type="text" value="X"/> W1 <input type="text" value="Y"/> W2 <input type="text" value="FG Color"/>	W0,1 <input type="text" value="X"/> W2,3 <input type="text" value="Y"/> W4,5 <input type="text" value="FG Color"/>	<input checked="" type="checkbox"/> Position <input checked="" type="checkbox"/> Size <input type="checkbox"/> FG Color	W0 <input type="text" value="X"/> W1 <input type="text" value="Y"/> W2 <input type="text" value="Width"/> W3 <input type="text" value="Height"/>	W0,1 <input type="text" value="X"/> W2,3 <input type="text" value="Y"/> W4,5 <input type="text" value="Width"/> W6,7 <input type="text" value="Height"/>	<input checked="" type="checkbox"/> Position <input checked="" type="checkbox"/> Size <input checked="" type="checkbox"/> FG Color	W0 <input type="text" value="X"/> W1 <input type="text" value="Y"/> W2 <input type="text" value="Width"/> W3 <input type="text" value="Height"/> W4 <input type="text" value="FG Color"/>	W0,1 <input type="text" value="X"/> W2,3 <input type="text" value="Y"/> W4,5 <input type="text" value="Width"/> W6,7 <input type="text" value="Height"/> W8,9 <input type="text" value="FG Color"/>
Data Type	16-Bit Unsigned Int. 16-Bit Signed Int. 16-Bit BCD	32-Bit Unsigned Int. 32-Bit Signed Int. 32-Bit BCD																								
<input type="checkbox"/> Position <input type="checkbox"/> Size <input checked="" type="checkbox"/> FG Color	W0 <input type="text" value="FG Color"/>	W0,1 <input type="text" value="FG Color"/>																								
<input type="checkbox"/> Position <input checked="" type="checkbox"/> Size <input type="checkbox"/> FG Color	W0 <input type="text" value="Width"/> W1 <input type="text" value="Height"/>	W0,1 <input type="text" value="Width"/> W2,3 <input type="text" value="Height"/>																								
<input type="checkbox"/> Position <input checked="" type="checkbox"/> Size <input checked="" type="checkbox"/> FG Color	W0 <input type="text" value="Width"/> W1 <input type="text" value="Height"/> W2 <input type="text" value="FG Color"/>	W0,1 <input type="text" value="Width"/> W2,3 <input type="text" value="Height"/> W4,5 <input type="text" value="FG Color"/>																								
<input checked="" type="checkbox"/> Position <input type="checkbox"/> Size <input type="checkbox"/> FG Color	W0 <input type="text" value="X"/> W1 <input type="text" value="Y"/>	W0,1 <input type="text" value="X"/> W2,3 <input type="text" value="Y"/>																								
<input checked="" type="checkbox"/> Position <input type="checkbox"/> Size <input checked="" type="checkbox"/> FG Color	W0 <input type="text" value="X"/> W1 <input type="text" value="Y"/> W2 <input type="text" value="FG Color"/>	W0,1 <input type="text" value="X"/> W2,3 <input type="text" value="Y"/> W4,5 <input type="text" value="FG Color"/>																								
<input checked="" type="checkbox"/> Position <input checked="" type="checkbox"/> Size <input type="checkbox"/> FG Color	W0 <input type="text" value="X"/> W1 <input type="text" value="Y"/> W2 <input type="text" value="Width"/> W3 <input type="text" value="Height"/>	W0,1 <input type="text" value="X"/> W2,3 <input type="text" value="Y"/> W4,5 <input type="text" value="Width"/> W6,7 <input type="text" value="Height"/>																								
<input checked="" type="checkbox"/> Position <input checked="" type="checkbox"/> Size <input checked="" type="checkbox"/> FG Color	W0 <input type="text" value="X"/> W1 <input type="text" value="Y"/> W2 <input type="text" value="Width"/> W3 <input type="text" value="Height"/> W4 <input type="text" value="FG Color"/>	W0,1 <input type="text" value="X"/> W2,3 <input type="text" value="Y"/> W4,5 <input type="text" value="Width"/> W6,7 <input type="text" value="Height"/> W8,9 <input type="text" value="FG Color"/>																								
Controllable	Position	Check this option when you want to control the position.																								
	Size	Check this option when you want to control the size.																								
	FG Color	Check this option when you want to control the FG color. This option is available when the Rectangle is Solid and the Pattern is not solid white.																								

Continued

Property			Description
Anchor Point			Select one of the following four corners of the dynamic rectangle to stay fixed as its size changes: Upper Left, Upper Right, Lower Left, and Lower Right. This item is available when Size is controllable but Position is not controllable.
Rectangle	Solid	Solid	Check this option if you want the dynamic rectangle to be filled with the selected pattern.
		Pattern	Select a pattern to fill the dynamic rectangle.
		FG Color	Select a color to paint the black part of the pattern. This item is available when the Pattern is not solid white.
		BG Color	Select a color to paint the white part of the pattern.
	Border	Border	Check this option if you want the dynamic rectangle to have a border.
		Border Color	The border color.

9.4. GIF Displays

You can use a GIF display to show a GIF image and control the animation of that image.

9.4.1. Operation Options

The following operation option can be added to a GIF display. Select and set up the option in the GIF Display property sheet.

Options	Description
Visibility Control	You can show or hide a GIF display by a specified bit or the current user level. Select and set up this option in the Visibility page.

9.4.2. Settings

You can complete all the settings of a GIF display in the GIF Display property sheet. This sheet contains the following two pages.

- **General**

Described in [Section 9.4.3.](#)

- **Visibility**



Described in [Section 4.4.6.](#)

9.4.3. General Settings

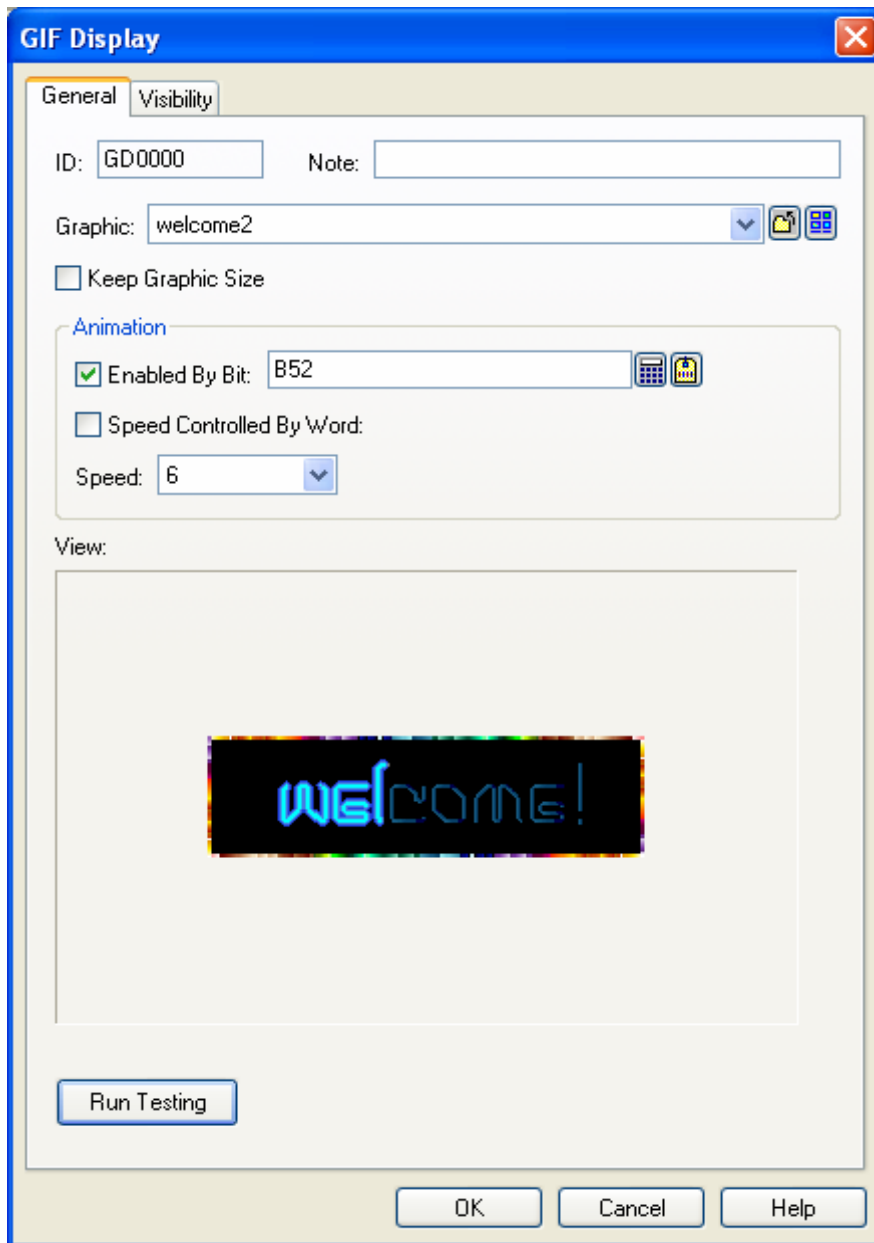



This section describes how to define the general settings for the GIF displays. The following is an example of the General page of the GIF Display property sheet.



The following table describes each property in the General page.

Property	Description
ID	The object's identifier. It is generated when the object is created. The identifier is unique within the screen where the object is located. The format of the IDs for the GIF displays is GDnnnn.
Note	You can type a note for the object.
Graphic	Select a GIF image for the GIF display. You can use the drop-down list to select a GIF image from the picture database. You can click  to select a GIF image from a file. You can click  to select a GIF image from a library file. If the selected GIF image is not from the picture database, it is imported and saved in the picture database.

Continued

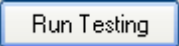
Property		Description
Keep Graphic Size		Check this option so the size of the selected graphic will not change with the object's size.
Animation	Enabled By Bit	Check this option so the animation will be enabled by the specified bit variable.
		Specifies the bit variable that enables the animation. Click  to enter an address for this field. Click  to select a tag for this field. The animation is enabled when the state of the variable is on.
	Speed Controlled By Word	Check this option so the speed of the animation will be controlled by the specified word variable.
		Specifies the variable that controls the speed of the animation. Click  to enter an address for this field. Click  to select a tag for this field. The value of the variable can be from 0 to 10. The slowest speed is 1 and the highest speed is 10. The value 0 disables the animation.
Speed	Select a speed from 1 to 10 for the animation. The slowest speed is 1 and the highest speed is 10.	
		Click this button to see the animation of the GIF display with the current settings on the screen.

9.5. Picture Displays

9.5.1. Basic Operations

You can use a variable to select and display a predefined picture with a picture display.

A picture display can have up to 256 states. Each state can have a predefined picture. The maximum number of states that a picture display can have is determined by the state type and the data type of the monitored variable. The following table shows the maximum in each case.

State Type	Type of Variable	Maximum
Bit	Bit	2
Value	16-bit	256
	32-bit	256
LSB	16-bit	17
	32-bit	33
Animation	Bit	256 Note: This is a special state type that is unique to picture displays. The bit variable is used to control the animation. When the bit is on, the animation is enabled. When the bit is off, the animation is disabled. The animation is performed by showing the picture of each state one by one at a specified change frequency.

You need to specify the number of states for a picture display and the number must not exceed the allowable maximum. You can define a picture for each state. At runtime, a picture display shows the picture corresponding to the state of the monitored variable. The state of the monitored variable is determined by the state type and value of the variable.

9.5.2. Operation Options

The following operation option can be added to a picture display. Select and set up the option in the Picture Display property sheet.

Options	Description
Visibility Control	You can show or hide a picture display by a specified bit or the current user level. Select and set up this option in the Visibility page.

9.5.3. Settings

You can complete all the settings of a picture display in the Picture Display property sheet. This sheet contains the following three pages.



- **General**
Described in [Section 9.5.4.](#)
- **Picture**
Described in [Section 4.3.7.](#)
- **Visibility**
Described in [Section 4.4.6.](#)

9.5.4. General Settings

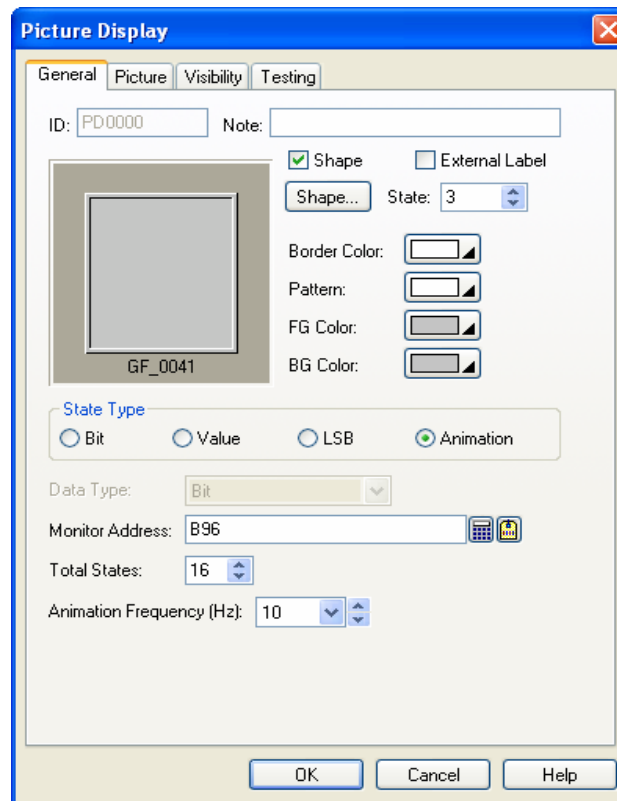
This section describes how to define the general settings for the picture displays. The following is an example of the General page of the Picture Display property sheet.



The following table describes each property in the General page.

Property		Description
ID		The object's identifier. It is generated when the object is created. The identifier is unique within the screen where the object is located. The format of the IDs for the picture displays is PDnnnn.
Note		You can type a note for the object.
Shape	Shape	Check this option if you want the picture display to have a frame.
	Shape settings	For details about the following properties, see Section 4.3.4 Setting up the Shape of an Object .  , Border Color, Pattern, FG Color, BG Color
External Label		Check this option if you want the picture display to have an external label. Set up the external label in the External Label page.
State		Select a state as the current state of the picture display so you can view and set the Pattern, FG Color, BG Color for that state.
State Type		The state type of the variable that controls the picture display. There are four state types you can select from: Bit, Value, LSB, and Bit For Enabling Animation. For details, see Section 9.5.1 Basic Operations .
Data Type		The data type of the variable that controls the picture display. The supported data types include: Bit, 16-bit Unsigned Integer, 16-bit BCD, 32-bit Unsigned Integer, and 32-bit BCD.
Monitor Address		Specifies the variable that controls the picture display. Click  to enter an address for this field. Click  to select a tag for this field.
Total State		The number of states for the picture display.
Animation Frequency (Hz)		The rate to change the picture.

9.6. Animated Graphics

An animated graphic can change its image and move along a specified path automatically. You can also change the position and image of an animated graphic at runtime by a specified variable. You can use BMP/JPG/GIF/Object Group for the animated graphics.

9.6.1. Operation Options

The following operation option can be added to an animated graphic. Select and set up the option in the Animated Graphic property sheet.

Options	Description
Visibility Control	You can show or hide an animated graphic by a specified bit or the current user level. Select and set up this option in the Visibility page.

9.6.2. Settings

You can complete all the settings of an animated graphic in the Animated Graphic property sheet. This sheet contains the following five pages. Some of the pages appear only when they are needed.

- **General**

Described in [Section 9.6.3.](#)

- **Picture**

Described in [Section 4.3.7.](#)

- **GIF**

Described in [Section 9.6.4.](#)

- **Path**

Described in [Section 9.6.5.](#)

- **Visibility**

Described in [Section 4.4.6.](#)

9.6.3. General Settings

This section describes how to define the general settings for animated graphics. The following is an example of the General page of the Animated Graphic property sheet.









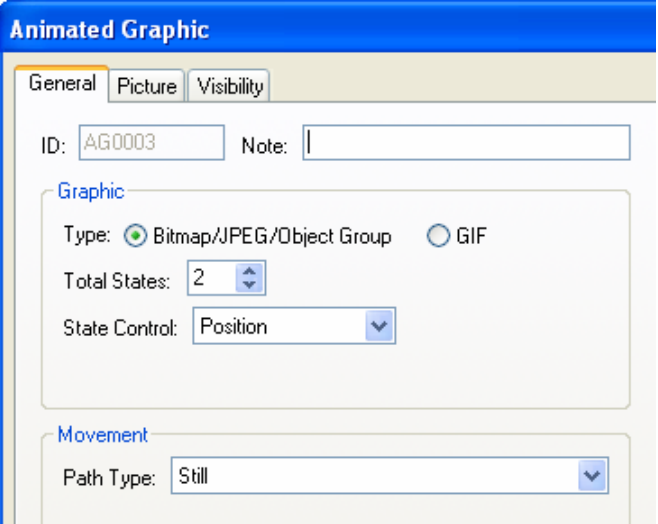

The following table describes each property in the General page.

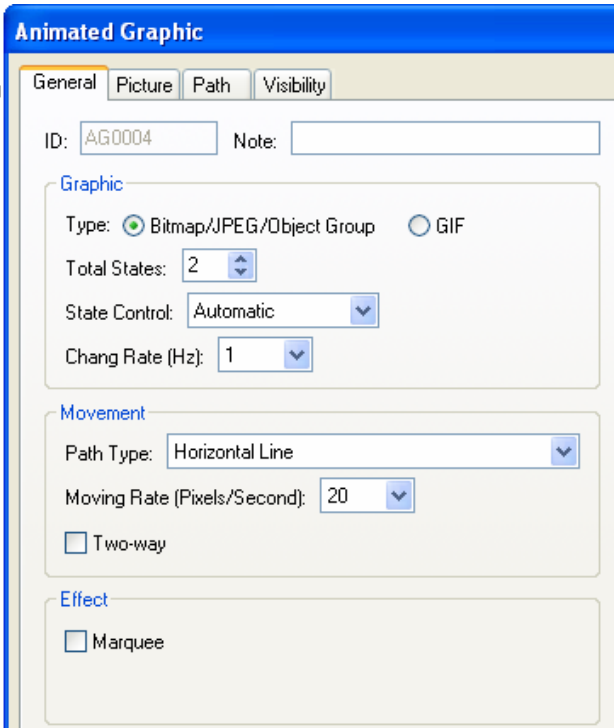
Property	Description
ID	The object's identifier. It is generated when the object is created. The identifier is unique within the screen where the object is located. The format of the IDs for the animated graphics is AGnnnn.
Note	You can type a note for the object.

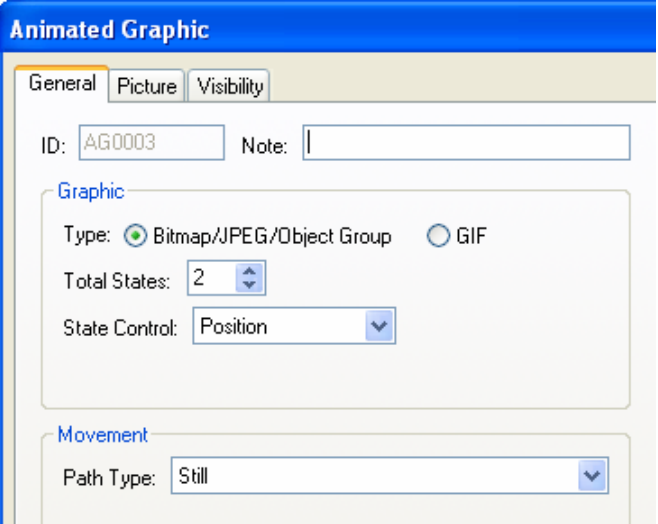

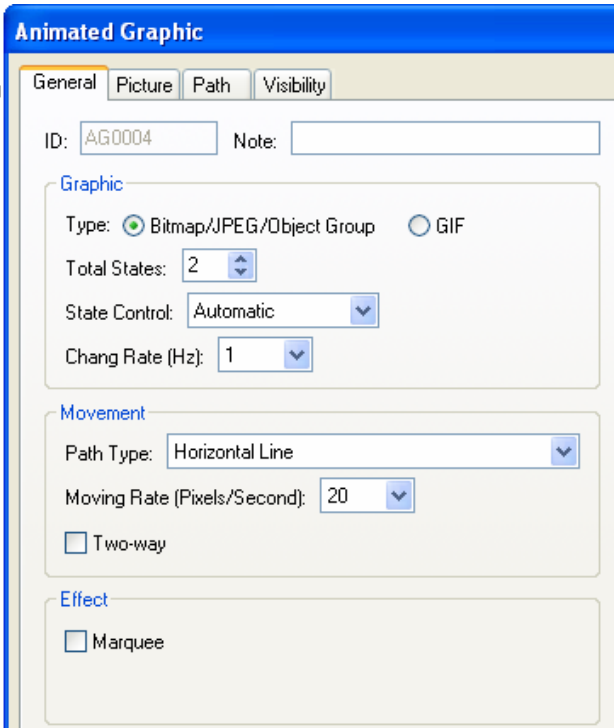

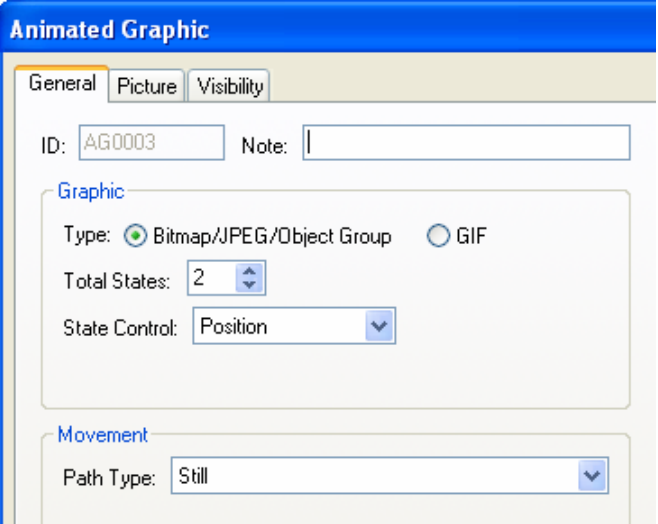

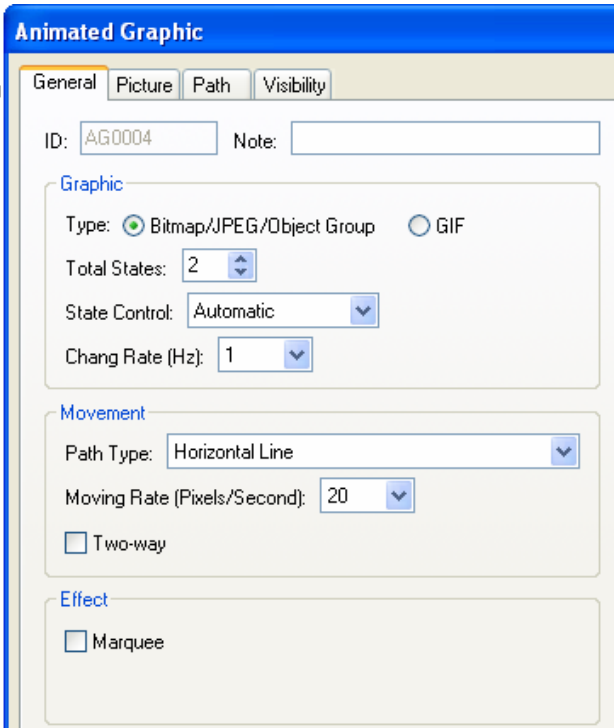
Continued

Property		Description	
Graphic	Type	Select one of the following graphic types for the animated graphic:	
		Type	Description
		Bitmap/JPEG/Object Group	You can configure the animated graphic to have up to 256 pictures. The pictures can be bitmap images, JPEG images, or object groups. Define the pictures in the Picture page. For details, see Section 4.3.7 Picture Settings .
		GIF	The animated graphic can have one GIF image. Define the GIF image in the GIF page. The speed of the animation for the GIF image is specified in the Change Rate field.
	Total States	The number of graphic states. You can specify a picture for each state. The animated graphic displays the associated picture for the current state.	
	State Control	Select one of the following methods to control the state of the animated graphic.	
		State Control	Description
		Automatic	The animated graphic changes the state in sequence starting from state 0 at a rate specified in the Change Rate field. When the current state is the last state, it will change back to state 0.
		Position	The state is determined by where the animated graphic is. In the Path page, you can define the associated state for each path point. For details, see Section 9.6.5 Path Settings .
		Dynamic	The state is determined at run time by the variable specified in the Monitor Address field.
		The animated graphic displays the associated picture for the current state.	
	Change Rate (Hz)	Select a rate when the State Control is Automatic or the Graphic Type is GIF.	

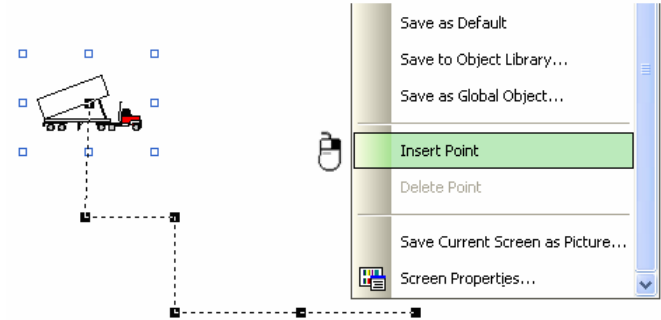

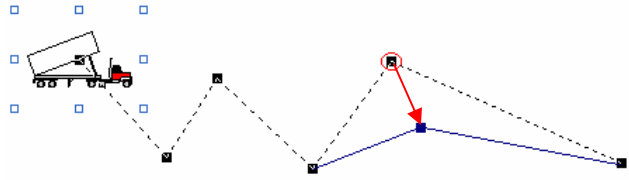
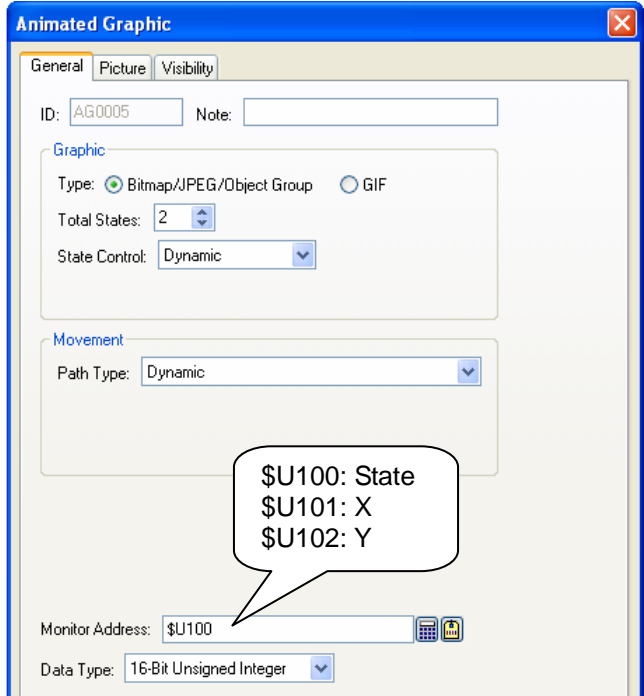
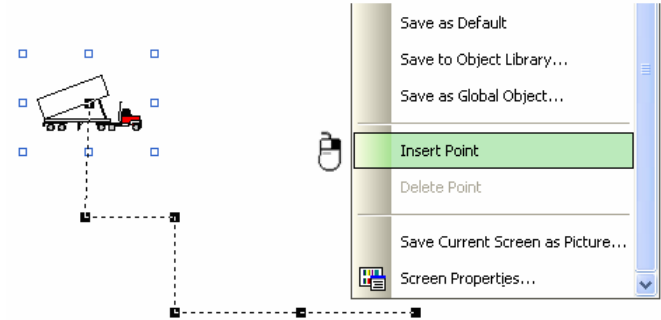
Continued

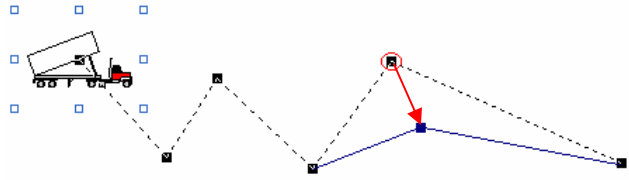
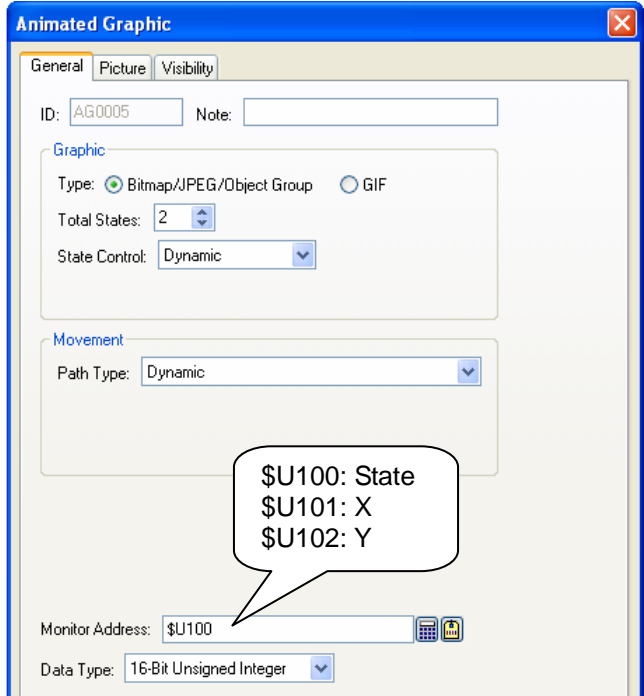
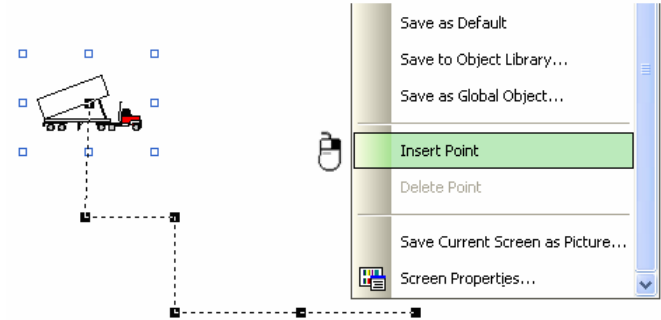
Property	Description									
Movement	Path Type	<p>There are six path types: Still, Horizontal Line, Vertical Line, Polyline, Dynamic, and Dynamic; Predefined Positions.</p> <p>Select one of the following path types for the animated graphic:</p> <table border="1" data-bbox="352 344 1497 1805"> <thead> <tr> <th data-bbox="352 344 523 383">Path Type</th> <th data-bbox="523 344 1497 383">Description</th> </tr> </thead> <tbody> <tr> <td data-bbox="352 383 523 958"> Still  </td> <td data-bbox="523 383 1497 958"> The animated graphic does not move.  </td> </tr> <tr> <td data-bbox="352 958 523 1731"> Horizontal Line  </td> <td data-bbox="523 958 1497 1731"> The animated graphic moves along a horizontal line.  </td> </tr> <tr> <td data-bbox="352 1731 523 1805"> Vertical Line </td> <td data-bbox="523 1731 1497 1805"> The animated graphic moves along a vertical line. </td> </tr> </tbody> </table>	Path Type	Description	Still 	The animated graphic does not move. 	Horizontal Line 	The animated graphic moves along a horizontal line. 	Vertical Line	The animated graphic moves along a vertical line.
Path Type	Description									
Still 	The animated graphic does not move. 									
Horizontal Line 	The animated graphic moves along a horizontal line. 									
Vertical Line	The animated graphic moves along a vertical line.									

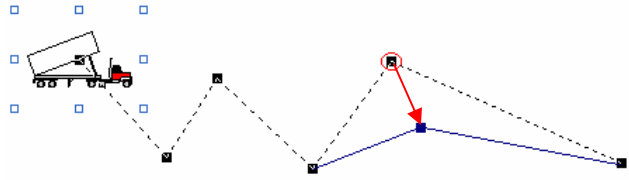
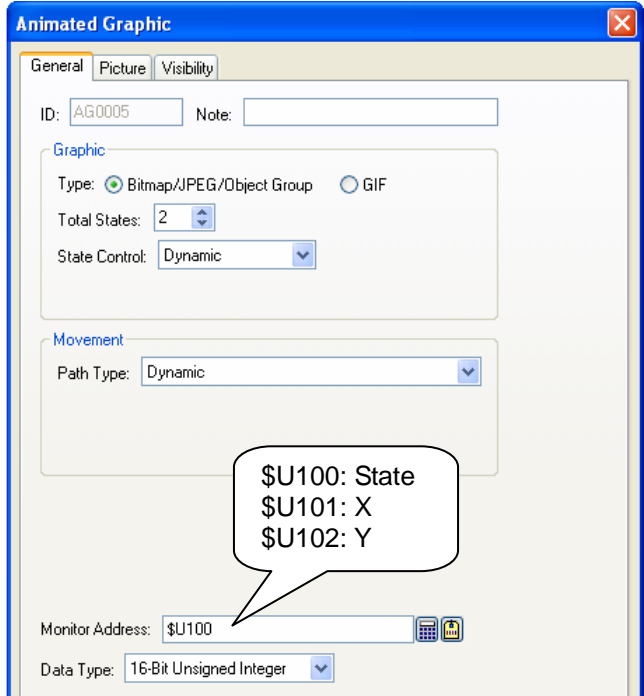
Continued

Property		Description								
Movement	Path Type	<table border="1"> <thead> <tr> <th>Path Type</th> <th>Description</th> </tr> </thead> <tbody> <tr> <td>Polyline</td> <td> <p>The animated graphic moves along a set of connected lines.</p> <p>Tips: You can right-click anywhere on the connected line and use the Insert Point command on the pop-up menu to insert a new point to the polyline. You can also right-click the existing point and use the Delete Point command to delete the point.</p>  <p>You can also position the mouse pointer over one of the points. When the cursor changes to , drag the point to the position you want.</p>  </td> </tr> <tr> <td>Dynamic</td> <td> <p>The position of the animated graphic is determined at runtime by the variable specified in the Monitor Address field. The data elements of the variable that specify the position are X and Y. They specify the coordinate of the position.</p>  </td> </tr> <tr> <td>Dynamic; Predefined Positions</td> <td> <p>The position of the animated graphic is determined at runtime by the variable specified in the Monitor Address field. The data element of the variable that specifies the position is Point. It specifies which point of the predefined path that the animated graphic should move to.</p> </td> </tr> </tbody> </table>	Path Type	Description	Polyline	<p>The animated graphic moves along a set of connected lines.</p> <p>Tips: You can right-click anywhere on the connected line and use the Insert Point command on the pop-up menu to insert a new point to the polyline. You can also right-click the existing point and use the Delete Point command to delete the point.</p>  <p>You can also position the mouse pointer over one of the points. When the cursor changes to , drag the point to the position you want.</p> 	Dynamic	<p>The position of the animated graphic is determined at runtime by the variable specified in the Monitor Address field. The data elements of the variable that specify the position are X and Y. They specify the coordinate of the position.</p> 	Dynamic; Predefined Positions	<p>The position of the animated graphic is determined at runtime by the variable specified in the Monitor Address field. The data element of the variable that specifies the position is Point. It specifies which point of the predefined path that the animated graphic should move to.</p>
		Path Type	Description							
		Polyline	<p>The animated graphic moves along a set of connected lines.</p> <p>Tips: You can right-click anywhere on the connected line and use the Insert Point command on the pop-up menu to insert a new point to the polyline. You can also right-click the existing point and use the Delete Point command to delete the point.</p>  <p>You can also position the mouse pointer over one of the points. When the cursor changes to , drag the point to the position you want.</p> 							
Dynamic	<p>The position of the animated graphic is determined at runtime by the variable specified in the Monitor Address field. The data elements of the variable that specify the position are X and Y. They specify the coordinate of the position.</p> 									
Dynamic; Predefined Positions	<p>The position of the animated graphic is determined at runtime by the variable specified in the Monitor Address field. The data element of the variable that specifies the position is Point. It specifies which point of the predefined path that the animated graphic should move to.</p>									

Continued

Property		Description																																				
Effect	Marquee	Check this option if you want the current picture of the animated graphic to scroll into both ends of its path. This option is available when the Path Type is Horizontal Line or Vertical Line.																																				
	Duplicate Picture	Check this option so the current picture of the animated graphic will be duplicated by a specified number of times. All the copies will display and move together. This option is available when the Marquee option is selected.																																				
	Number of Copies	Specifies the number of copies to make for the Duplicate Picture option.																																				
Monitor Address		<p>Specifies the variable that controls the animated graphic.</p> <p>Click  to enter an address for this field. Click  to select a tag for this field.</p> <p>The following table shows the data arrangement of the variable:</p> <table border="1"> <thead> <tr> <th rowspan="2">Settings</th> <th>Data Type</th> <th>16-Bit Unsigned Int. 16-Bit Signed Int. 16-Bit BCD</th> <th>32-Bit Unsigned Int. 32-Bit Signed Int. 32-Bit BCD</th> </tr> </thead> <tbody> <tr> <td>State Control = Dynamic</td> <td>W0</td> <td><input type="text" value="State"/></td> <td>W0,1 <input type="text" value="State"/></td> </tr> <tr> <td rowspan="2">Path Type = Dynamic</td> <td>W0</td> <td><input type="text" value="X"/></td> <td>W0,1 <input type="text" value="X"/></td> </tr> <tr> <td>W1</td> <td><input type="text" value="Y"/></td> <td>W2,2 <input type="text" value="Y"/></td> </tr> <tr> <td>Path Type = Dynamic; Predefined Positions</td> <td>W0</td> <td><input type="text" value="Point"/></td> <td>W0,1 <input type="text" value="Point"/></td> </tr> <tr> <td rowspan="3">State Control = Dynamic Path Type = Dynamic</td> <td>W0</td> <td><input type="text" value="State"/></td> <td>W0,1 <input type="text" value="State"/></td> </tr> <tr> <td>W1</td> <td><input type="text" value="X"/></td> <td>W2,3 <input type="text" value="X"/></td> </tr> <tr> <td>W2</td> <td><input type="text" value="Y"/></td> <td>W4,5 <input type="text" value="Y"/></td> </tr> <tr> <td rowspan="2">State Control = Dynamic Path Type = Dynamic; Predefined Positions</td> <td>W0</td> <td><input type="text" value="State"/></td> <td>W0,1 <input type="text" value="State"/></td> </tr> <tr> <td>W1</td> <td><input type="text" value="Point"/></td> <td>W2,3 <input type="text" value="Point"/></td> </tr> </tbody> </table>	Settings	Data Type	16-Bit Unsigned Int. 16-Bit Signed Int. 16-Bit BCD	32-Bit Unsigned Int. 32-Bit Signed Int. 32-Bit BCD	State Control = Dynamic	W0	<input type="text" value="State"/>	W0,1 <input type="text" value="State"/>	Path Type = Dynamic	W0	<input type="text" value="X"/>	W0,1 <input type="text" value="X"/>	W1	<input type="text" value="Y"/>	W2,2 <input type="text" value="Y"/>	Path Type = Dynamic; Predefined Positions	W0	<input type="text" value="Point"/>	W0,1 <input type="text" value="Point"/>	State Control = Dynamic Path Type = Dynamic	W0	<input type="text" value="State"/>	W0,1 <input type="text" value="State"/>	W1	<input type="text" value="X"/>	W2,3 <input type="text" value="X"/>	W2	<input type="text" value="Y"/>	W4,5 <input type="text" value="Y"/>	State Control = Dynamic Path Type = Dynamic; Predefined Positions	W0	<input type="text" value="State"/>	W0,1 <input type="text" value="State"/>	W1	<input type="text" value="Point"/>	W2,3 <input type="text" value="Point"/>
Settings	Data Type	16-Bit Unsigned Int. 16-Bit Signed Int. 16-Bit BCD		32-Bit Unsigned Int. 32-Bit Signed Int. 32-Bit BCD																																		
	State Control = Dynamic	W0	<input type="text" value="State"/>	W0,1 <input type="text" value="State"/>																																		
Path Type = Dynamic	W0	<input type="text" value="X"/>	W0,1 <input type="text" value="X"/>																																			
	W1	<input type="text" value="Y"/>	W2,2 <input type="text" value="Y"/>																																			
Path Type = Dynamic; Predefined Positions	W0	<input type="text" value="Point"/>	W0,1 <input type="text" value="Point"/>																																			
State Control = Dynamic Path Type = Dynamic	W0	<input type="text" value="State"/>	W0,1 <input type="text" value="State"/>																																			
	W1	<input type="text" value="X"/>	W2,3 <input type="text" value="X"/>																																			
	W2	<input type="text" value="Y"/>	W4,5 <input type="text" value="Y"/>																																			
State Control = Dynamic Path Type = Dynamic; Predefined Positions	W0	<input type="text" value="State"/>	W0,1 <input type="text" value="State"/>																																			
	W1	<input type="text" value="Point"/>	W2,3 <input type="text" value="Point"/>																																			
Data Type		The data type of the variable that controls the animated graphic. The supported data types include: 16-bit Unsigned Integer, 32-bit Unsigned Integer, 16-bit Signed Integer, 32-bit Signed Integer, 16-bit BCD, and 32-bit BCD.																																				

9.6.3.1. Using Object Group for Animated Graphics

You can use an object group for the animated graphic.

To create an object group, you can first group the selected objects and then save the group into the object library.

To use the object group, you can click the  button in the Picture page to bring up the Copy Object from Object Library dialog box. In the dialog, you can select an existing object group for the animated graphic.

Any modifications such as moving the group, resizing the group, deleting the group etc. will be applied to the objects of the group at the same time. However, each object in the group can have its own properties. You can double click the  icon to bring up the properties dialog box of the corresponding object and then define the settings of each object.

The following is an example showing you how to edit the object group for the animated graphic. The object group includes a numeric entry, a numeric display and a picture object. They will move along the set of connected lines. At the same time, the value of numeric entry and the numeric display will change.

1. Set up the animated graphic with the object group as its graphic.

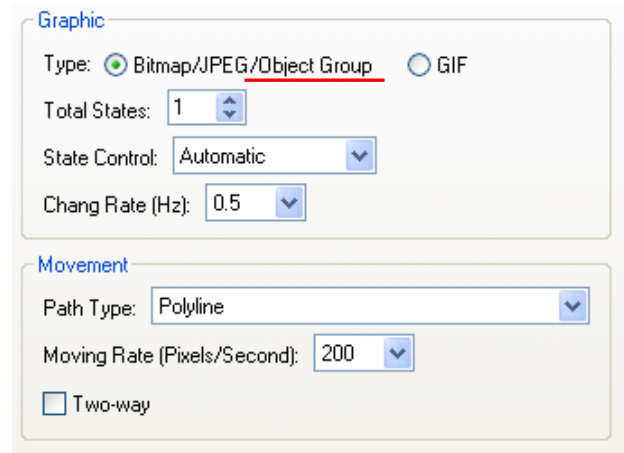
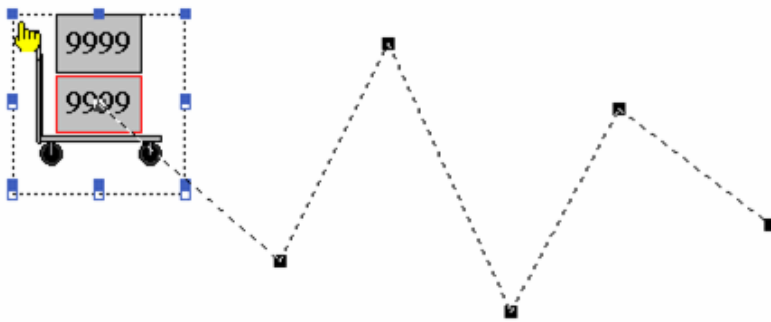

2. Set up the picture object

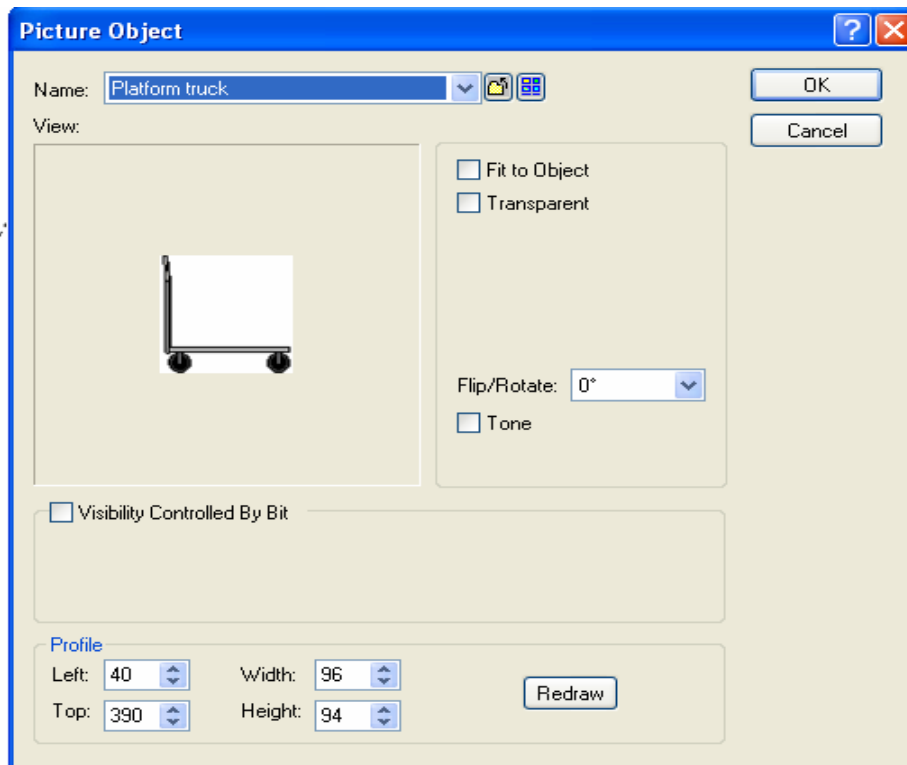
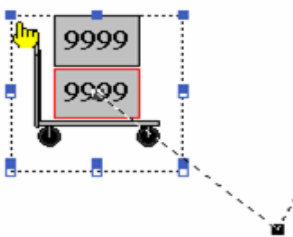

3. Set up the numeric entry

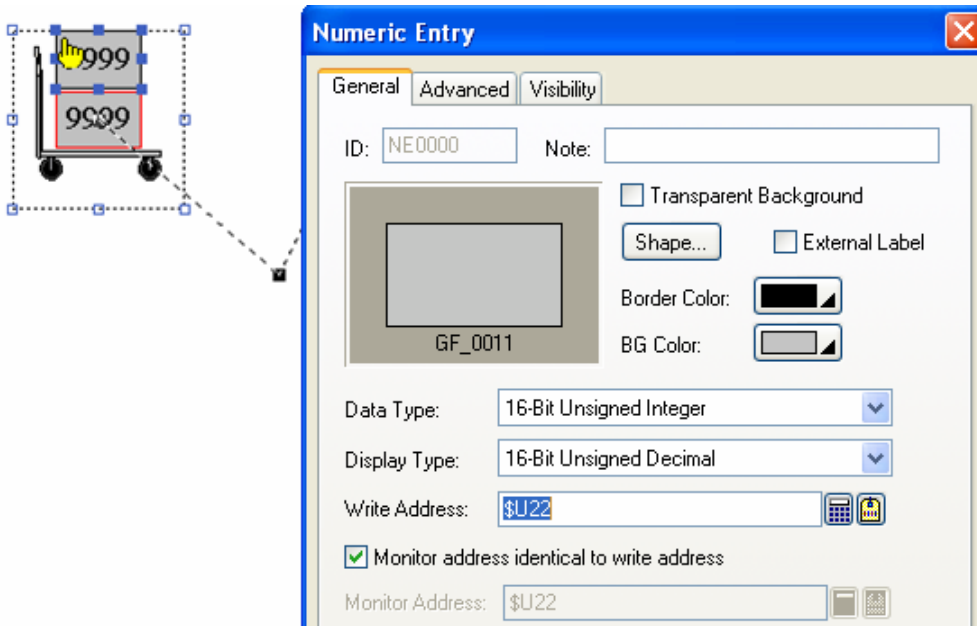

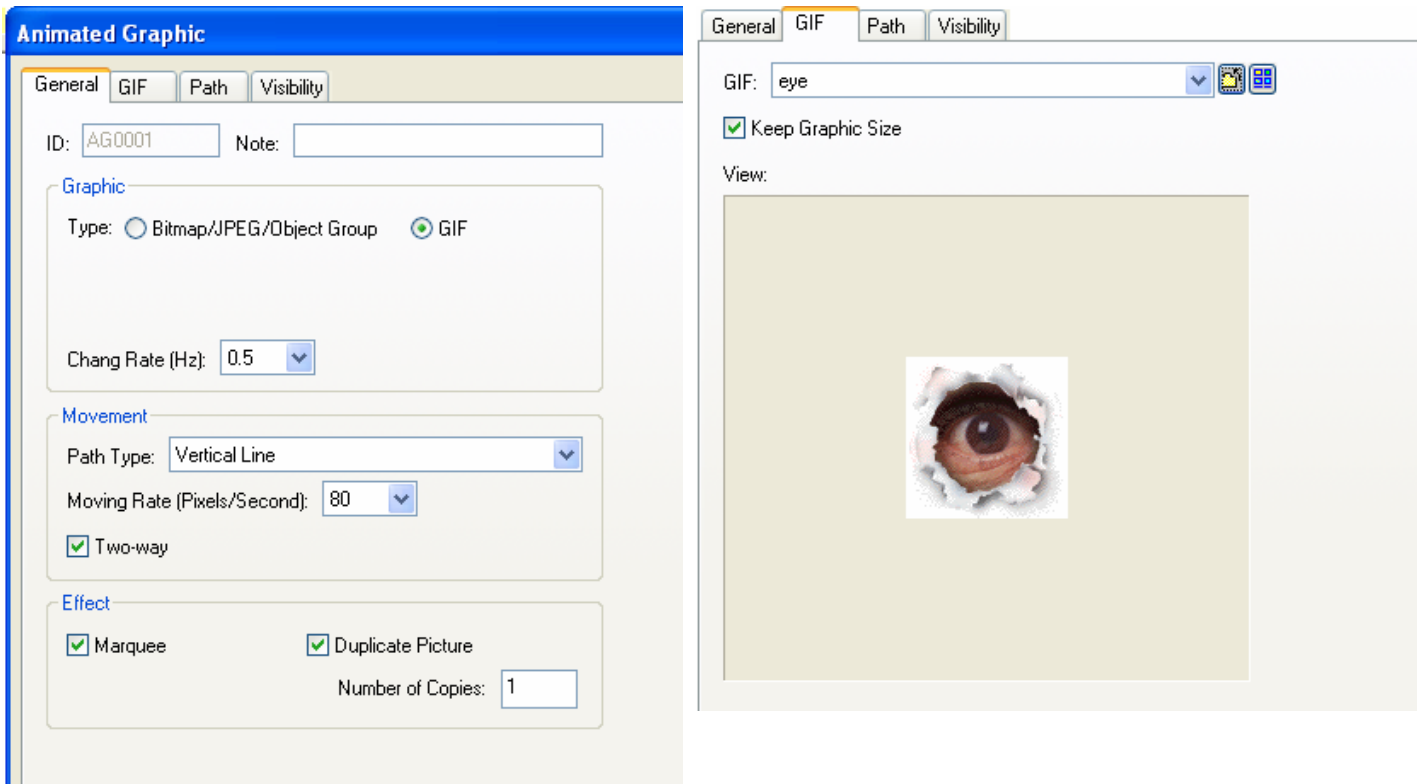

9.6.4. GIF Settings

This section describes how to define the GIF image for animated graphics. The following is an example of the GIF page.



The following table describes each property in the GIF page.

Property	Description
GIF	Select a GIF image for the animated graphic. You can use the drop-down list to select a GIF image from the picture database. You can click  to select a GIF image from a file. You can click  to select a GIF image from a library file. If the selected GIF image is not from the picture database, it is imported and saved in the picture database.
Keep Graphic Size	Check this option so the size of the selected GIF image will not change with the object's size.

9.6.5. Path Settings

This section describes how to define the path settings for animated graphics. You can easily define the path of an animated graphic in the editing window. To edit the path of an animated graphic, click it to display the path as shown in the following example.

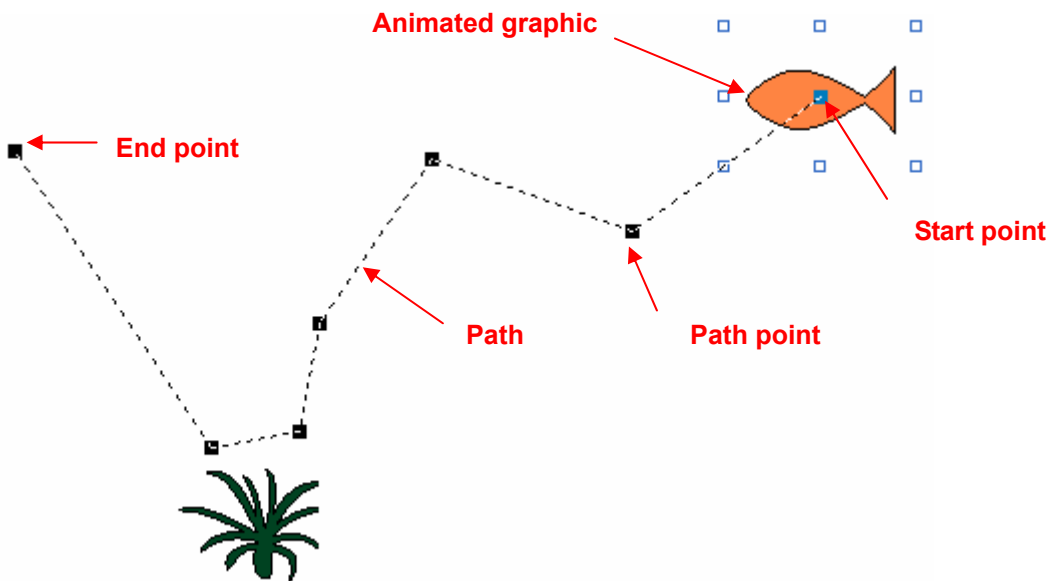

To modify the path, drag the path points to desired positions. You can insert a path point by right-clicking at the desired position on the path and clicking Insert Point from the popup menu. To delete a path point, right-click at the path point and click Delete Point on the popup menu. Use the Path page to define all the properties of the path.

The following is an example of the Path page.

P#	X	Y	S#(F)	Pic(F)	S#(B)	Pic(B)
0	622	91	0	Fish		
1	528	158	0	Fish	1	Fish2
2	428	122	0	Fish	1	Fish2
3	372	204	0	Fish	1	Fish2
4	362	258	0	Fish	1	Fish2
5	318	266	0	Fish	1	Fish2
6	220	118			1	Fish2

Point

X: Y:

Picture for Forward Movement

State: Name:

Picture for Backward Movement

State: Name:

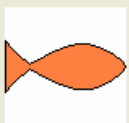
The following table describes each property in the Path page.

Property		Description
X		The horizontal coordinate of the selected path point.
Y		The vertical coordinate of the selected path point.
Picture for Forward Movement	State	The associated state of the selected path point for forward movement.
	Name	The associated picture name of the selected state. It is also the associated picture name of the selected path point for forward movement.
Picture for Backward Movement	State	The associated state of the selected path point for backward movement.
	Name	The associated picture name of the selected state. It is also the associated picture name of the selected path point for backward movement.

CHAPTER 10

RECIPES AND RECIPE OBJECTS

10.1. Recipes	1
10.2. Recipe Data Flow and Memory Allocation	2
10.3. Working with Recipes	3
10.4. Transferring Recipes	4
10.4.1. Between the PC and HMI	4
10.4.2. Between the HMI and USB Memory Stick/Micro SD Card	4
10.4.3. Between the battery backed memory and flash ROM	4
10.4.4. Between the HMI and PLC/Controller	5
10.5. Setting up Recipe Blocks.....	6
10.5.1. General Settings.....	6
10.5.2. Data Item Settings.....	9
10.6. Selecting a Recipe Using Recipe Selectors	11
10.6.1. Basic Operations	11
10.6.2. Operation Options.....	12
10.6.3. Settings	12
10.6.4. General Settings.....	12
10.7. Displaying and Modifying Recipe Data Using Recipe Tables	14
10.7.1. Basic Operations	14
10.7.2. Operation Options.....	15
10.7.3. Settings	15
10.7.4. General Settings.....	15
10.7.5. Data Item Settings.....	17

In this chapter we will explain how recipes in the software can be set up, stored and transferred. We also describe how to configure the basic functions and recipe objects (recipe selector and recipe table) used for recipes.

10.1. Recipes

■ Recipe Block

A recipe block is a memory block that stores recipe data as a two dimensional array in the panel. The memory size of each recipe block is the product of the size of a recipe by the number of recipes in word. You can create up to 16 recipe blocks for your application. Each recipe block can contain at most 65535 recipes. Each recipe can have as many as 4096 words of data.

■ Recipe

A recipe is a group of data items. You can use a recipe number or a recipe name to index a recipe in the corresponding recipe block.

The recipe number is a unique number between 0 and the total number of recipes. The current recipe number of the recipe block m is saved in the current recipe number register \$RNm (m: The recipe block ID).

The recipe name can be represented by ASCII or Unicode String. To specify ASCII or Unicode String as the recipe name, you need to open the dialog box of a recipe block and set the data type of the related data item into ASCII or Unicode String in the data item page. For details about recipe data item settings, please see [Section 10.5.2](#).

■ Recipe Data Item

A data item is a word or words of data used to represent an application related data or a machine setup parameter used in process and production control. You can specify the format such as name, data type, size, scaling and range check for each data item in the recipe block dialog box.

The following is a sample of a recipe block with 3 recipes and each recipe has 8 data items.

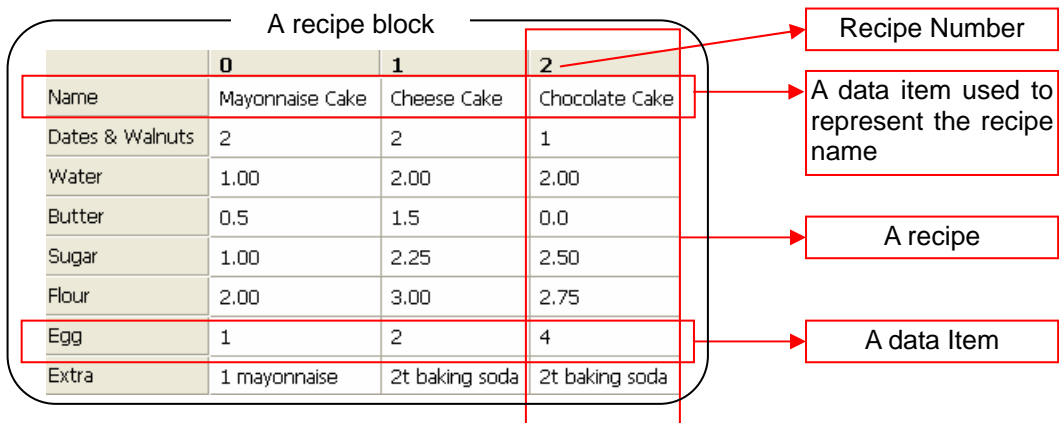

■ Recipe Data

There are two types of recipe data: TXT Data and PRD Data. These recipes can be transferred directly between the PC and HMI or between the HMI and USB Memory Stick/Micro SD card.

Recipe Data	Description
TXT Data	<ul style="list-style-type: none"> Can be created and edited in Microsoft Excel or text editor software (e.g., Notepad)
PRD Data	<ul style="list-style-type: none"> Binary Data created in the software Can be edited in RecipeEditor

10.2. Recipe Data Flow and Memory Allocation

Assume there are two recipe blocks (Recipe Block 0 and Recipe Block 9) in an application. Recipe Block 0 has 3 recipes and each recipe has 4 data items named A, B, C and D. Recipe Block 9 has 2 recipes and each recipe has 3 data items named E, F and G.

The following illustration gives an overview of recipe data flow and recipe memory allocation.

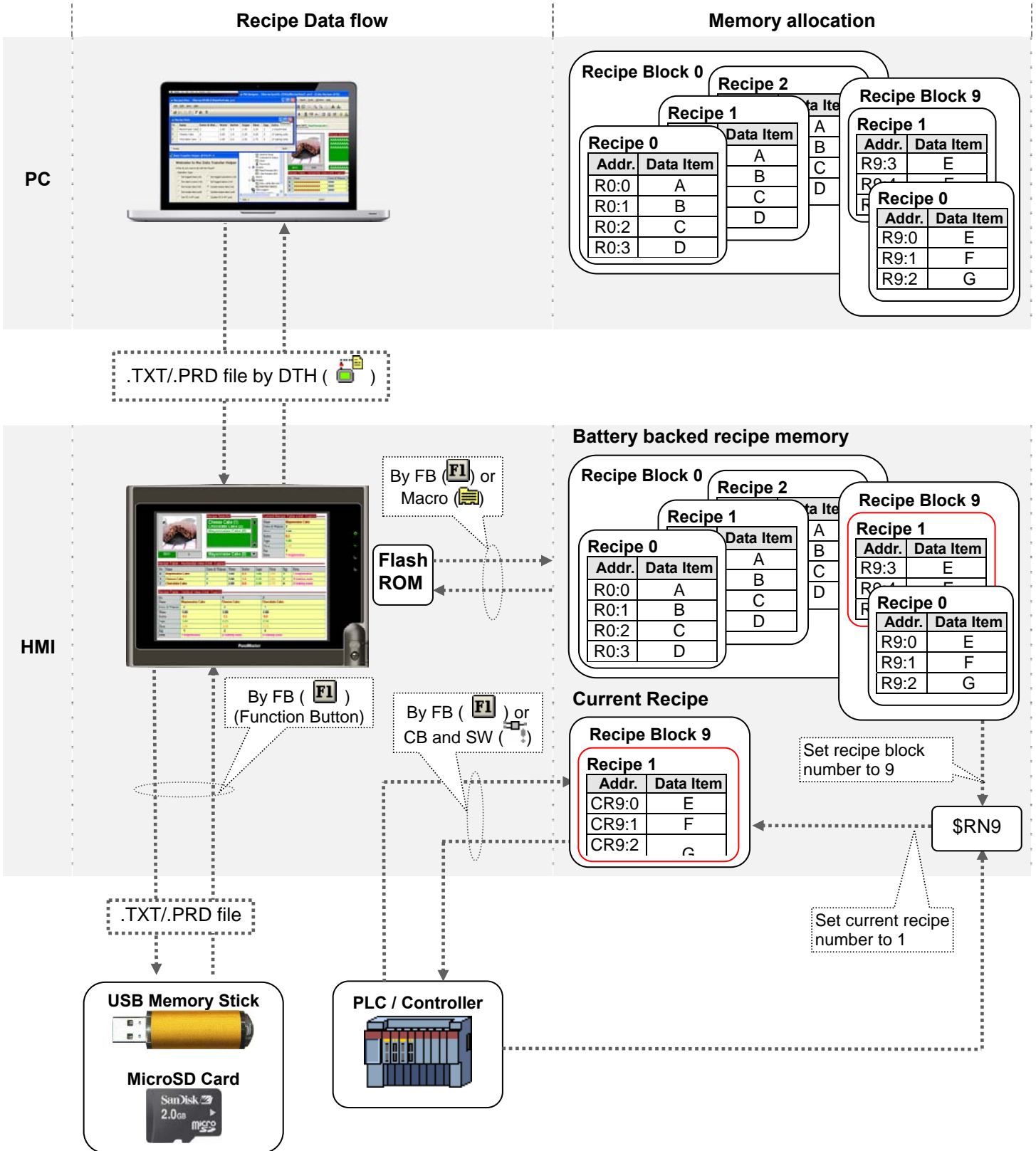

10.3. Working with Recipes

To work with recipes, you need to do the following:

■ **Create and set up a recipe block**

To create a recipe block, you may do one of the following:

- 1) In the Project Manager tool window, right-click the Recipes node of the concerned panel application and select Add Recipe Block.
- 2) In the menu bar, click Panel to bring up the Panel sub-menu. Click Recipe Block in the Panel sub-menu to bring up the Recipe Block pop-up menu. Select Add in the pop-up menu.

For details about how to set up a recipe block, please see [Section 10.5](#).

■ **View and edit recipe data on a PC**

On a PC, you can use RecipeEditor to view and edit recipe data saved in *.prd file. The following is an example of the RecipeEditor.

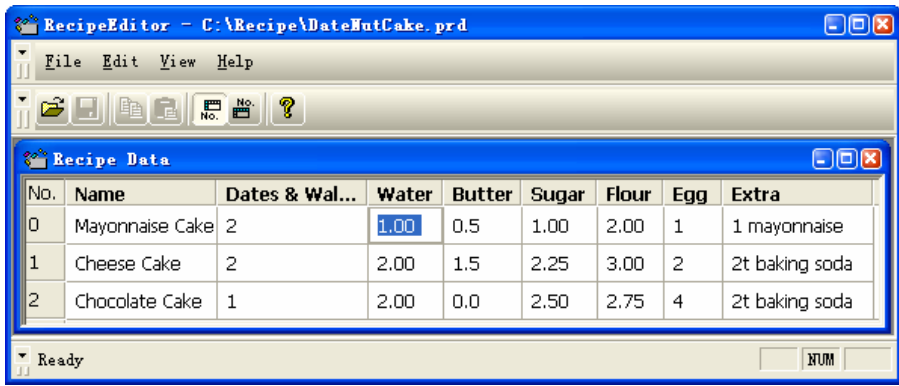

▶▶ To run the RecipeEditor, choose Start > Programs > "The software" > RecipeEditor.

▶▶ To edit recipe data directly in the cell, right click the cell and key in the value you want. Note that any value not matched with the predefined format will cause an error when using the recipe at runtime.

■ **View and edit recipe data on a HMI**

On a HMI, you can use a recipe table to view and edit recipe data. For details about how to create and set up a recipe table for an application, please see [Section 10.7](#).

■ **Select a recipe on HMI**

On a HMI, you can select a recipe by using recipe selector. For details about how to create and set up a recipe selector for an application, please see [Section 10.6](#).

■ **Transfer recipes**

Described in [Section 10.4](#)

10.4. Transferring Recipes

10.4.1. Between the PC and HMI

■ Using Data Transfer Helper (DTH) ()

You can use DTH to download recipe data in *.prd/*.txt file from a PC to a HMI. With DTH, you can also get recipe data from a HMI and save the data in *.prd/*.txt file on to a PC. The following is an example of the Data Transfer Helper (DTH) used to get or update recipe data.

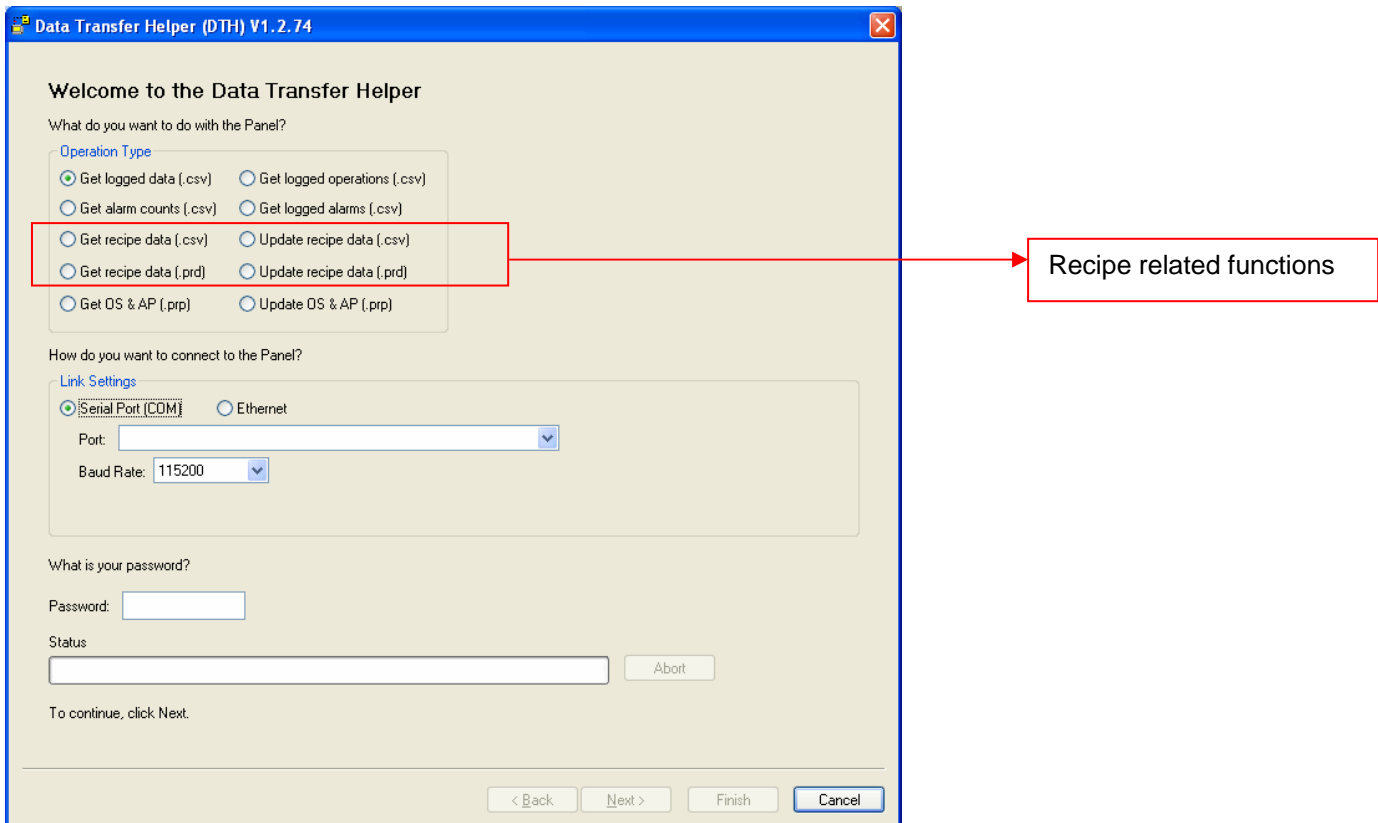

To run the DTH, choose Start > Programs > “The software” >  Data Transfer Helper (DTH).

10.4.2. Between the HMI and USB Memory Stick/Micro SD Card

■ Using the Function Button ()

You can use a function button to save recipe data of the specified recipe block as a .txt\prd file, or load recipe data of the specified recipe block from a .txt\prd file. For details, please see [Section 5.4.1 Basic Operations](#) of function buttons

10.4.3. Between the battery backed memory and flash ROM

■ Using Macro Command ()

You can use RB2ROM to save the data of the specified recipe block to a flash ROM, and use ROM2RB to load recipe data from a flash ROM. For details, please see [Section 5.4.1 Basic Operations](#) of Macro command

■ Using Function Button ()

You can use a function button to save recipe data to a flash ROM, and load recipe data from a flash ROM. For details, please see [Section 5.4.1 Basic Operations](#) of function buttons

10.4.4. Between the HMI and PLC/Controller

■ Using Command Block and Status Words ()

You can use the command flag setting in Command Block to request the panel to set the current recipe number, read a recipe from a PLC or write a recipe to a PLC. You can also receive current the recipe block ID or current recipe number by checking the related status word and specifying the word variable in Status Words. For details, please see [Section 3.5.1 Command Block and Status Words](#).

To change the current recipe number, the PLC first sets the Parameter Two Register to the desired recipe block and the Parameter One Register to the desired recipe number, then turns on the Set Current Recipe Number (#2) command flag. Also, \$RNm (Current Recipe Number Register, m: Recipe Block ID) of the panel can be changed by the PLC.

To update a recipe in the panel, the PLC first sets the Parameter Two Register to the desired recipe block and the Parameter One Register to the desired recipe number, then turns on the Read Recipe From PLC (#3) command flag. The panel reads data in the Recipe Block to update the specified recipe in the panel.

To receive a recipe, the PLC first sets the Parameter Two Register to the desired recipe block and the Parameter One Register to the desired recipe number, then turns on the Write Recipe To PLC (#4) command flag. The panel sends the specified recipe data to the Recipe Block in the PLC.

Note: You do not need to specify the recipe block if the application has only one recipe block.

Note: To make the above operation work, the specified recipe block must exist, or else the panel ignores the request. The specified recipe number in the Parameter One Register must be between 0 and the maximum recipe number - 1. If the Parameter One Register is greater than or equal to the maximum recipe number, the panel ignores the request.

■ Using the Function Button ()

You can use a function button to write the current recipe to the controller, or update current the recipe by reading the recipe from the controller. For details, please see [Section 5.4.1 Basic Operations](#) of function buttons

10.5. Setting up Recipe Blocks

You can set up a recipe block with the Recipe Block dialog box. There are two ways to open the dialog box of a recipe block:

- 1) In the Project Manager window, right-click the node of the desired Recipe Block and select Properties.
- 2) In the menu bar, click Panel to bring up the Panel sub-menu. Click Recipes in the Panel sub-menu to bring up the Recipe Block pop-up menu. Select Properties in the pop-up menu to bring up the recipe block list of the current panel application. Select the recipe block in the list.

The Recipe Block dialog box contains the following two pages:

- **General**

Described in [Section 10.5.1](#).

- **Data Item**

Described in [Section 10.5.2](#).

10.5.1. General Settings

Use the General page to define the general settings for a recipe block. The following is an example of the General page.

Recipe Block

General | Data Item

Name: ID:

Recipe Size: words Number Of Recipes:

Memory Required: words

Write Recipe To PLC

Write Address:

Notification Bit:

Read Recipe From PLC Read Address Identical To Write Address

Read Address:

Notification Bit:

Read/Write Size: words

Reverse the order of the high word and low word of 32-bit data

Recipe Memory

Bit Address Range:

Word Address Range:

Current Recipe









Bit Address Range:

Word Address Range:

Current Recipe Number Register:

OK Cancel Help

The table below describes each property in the General page.

Property	Description									
Name	The recipe block's name. The maximum length of the name is 48 characters.									
ID	The recipe block's ID number. Select a number between 0 and 15. The number is unique among all recipe blocks of the panel application.									
Recipe Size	Specifies the data size that each recipe contains. The unit is word.									
Number of Recipes	Specifies the maximum number of recipes that the recipe memory can hold.									
Memory Required	The size of the recipe memory. The unit is word. The formula to calculate the size is: Memory Required = Recipe Size * Number of Recipes									
Write Recipe To PLC	Check the option if you want to write the recipe to PLC									
Write Address	Available when Write Recipe To PLC is checked. Specifies the variable that is the starting address of the Recipe Block in your PLC. Click  to enter an address for this field. Click  to select a tag for this field. The size of the recipes to be written is specified in the Read/Write Size field.									
Notification	Check this option if you want the recipe to set the bit specified in the Bit Field to On when it finishes writing a recipe to PLC.									
Bit	Available when the Notification field is checked. Specifies the bit for the operation done notification. Click  to enter an address for this field. Click  to select a tag for this field.									
Read Recipe From PLC	Check this option if you want to read recipes from PLC.									
Read Address Identical To Write Address	Specifies that the Read Address is identical to the Write Address. With this item checked, you don't need to specify the Read Address again. This item is available when the option Read Recipe From PLC is checked.									
Read Address	Available when Read Recipe From PLC is checked. Specifies the variable representing the starting address of the recipe block on your PLC. Click  to enter an address for this field. Click  to select a tag for this field. The size of the recipes to be read is specified in the Read/Write Size field.									
Notification	Check the option if you want the recipe to set the bit specified in the Bit Field to On when it finishes reading a recipe from PLC.									
Bit	Available when the Notification field is checked. Specifies the bit for the operation done notification. Click  to enter an address for this field. Click  to select a tag for this field.									
Read/Write Size	The size of the recipe for reading and writing.									
Reverse the order of the high word and low word of 32-bit data	Check this option if the Write Address or the Read Address belongs to a controller that stores data in big-endian byte order and if there are 32-bit data items, such as 32-bit signed integers and 32-bit floating point numbers, defined in the recipe block.									
Recipe Memory	Set the overall recipe block's address range in the internal memory of the panel. <table border="1" data-bbox="478 1644 1481 1863"> <thead> <tr> <th>Range Type</th> <th>Address Format</th> <th>Description</th> </tr> </thead> <tbody> <tr> <td>Bit Address Range</td> <td>\$Rm:n.b b: 0-f</td> <td>Each bit address in the range refers to a bit of a recipe word in the specified recipe block.</td> </tr> <tr> <td>Word Address Range</td> <td>\$Rm:n</td> <td>Each word address in the range refers to a recipe word</td> </tr> </tbody> </table> <p>Legend: m = Recipe Block ID, n = The Number of Recipe Word, b = Bit Number</p>	Range Type	Address Format	Description	Bit Address Range	\$Rm:n.b b: 0-f	Each bit address in the range refers to a bit of a recipe word in the specified recipe block.	Word Address Range	\$Rm:n	Each word address in the range refers to a recipe word
Range Type	Address Format	Description								
Bit Address Range	\$Rm:n.b b: 0-f	Each bit address in the range refers to a bit of a recipe word in the specified recipe block.								
Word Address Range	\$Rm:n	Each word address in the range refers to a recipe word								

Continued

Property	Description		
Current Recipe	Set the current recipe's address range in the internal memory of the panel.		
	Range Type	Address Format	Description
	Bit Address Range	\$CRm:n.b b: 0-f	Each bit address in the range refers to a bit of a recipe word in the current recipe of the specified recipe block.
	Word Address Range	\$CRm:n	Each word address in the range refers to a recipe word in the current recipe of the specified recipe block.
Current Recipe Number Register	\$RNm	An internal register of the panel that specifies the current recipe number of the specified recipe block.	
Legend: m = Recipe Block ID, n = The Number of Recipe Word, b = Bit Number.			
Need space in flash ROM to save backup	Check this option if you need space in the flash ROM to save backup recipes.		
Do not use battery backed RAM	Check this option so the recipe memory will be located in the ordinary RAM, and the recipe memory will be cleared whenever the target panel is powered up. If this option is not selected, so the recipe memory will be located in the battery backed RAM. The recipe data will not be lost after power down if the battery backed RAM is used.		

10.5.2. Data Item Settings

Use the Data Item page to define the data items of the data for a recipe block. The following is an example of the Data Item page.

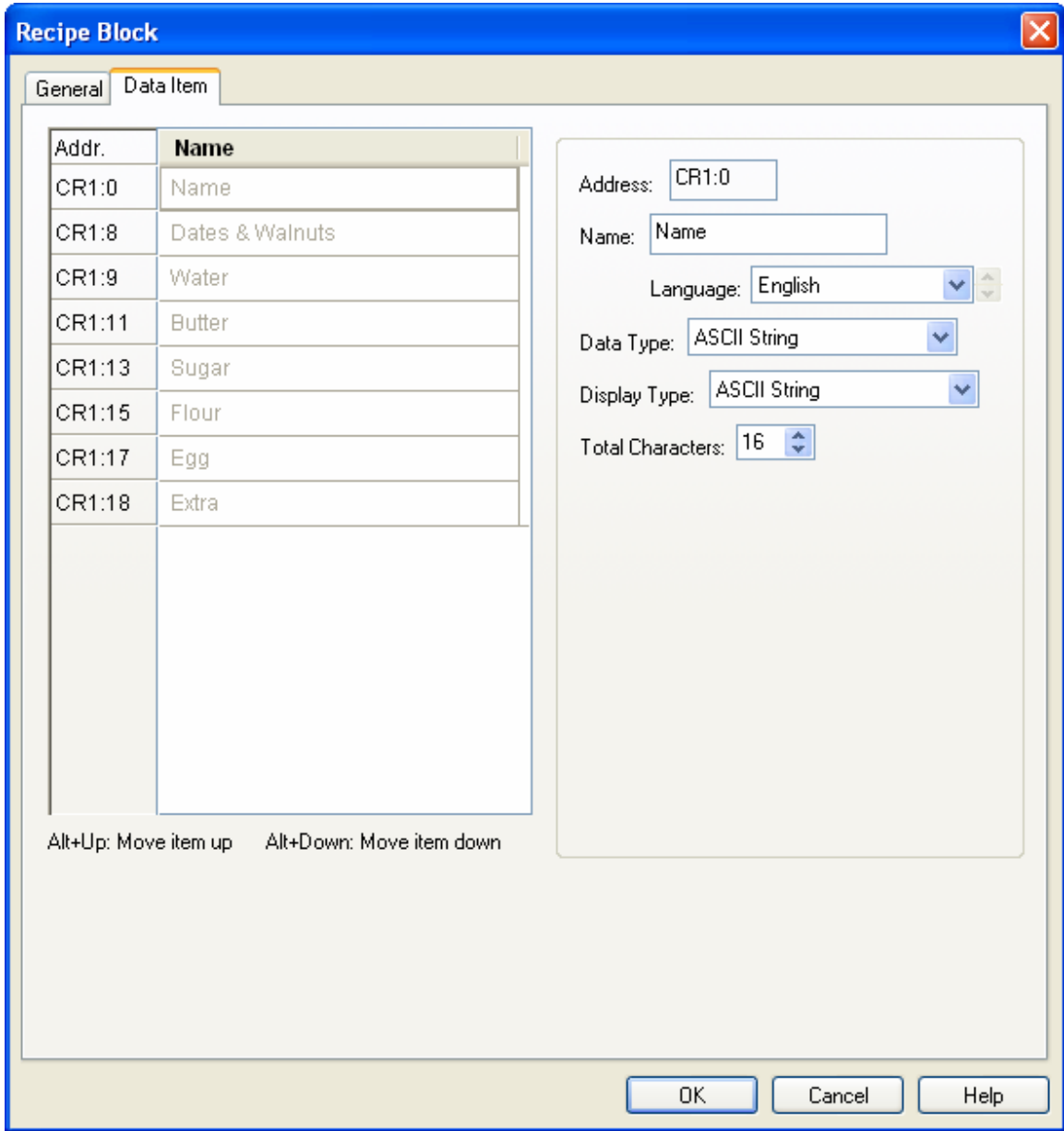

The Data Item page contains two parts. The left side of the data item list shows the address and name of each data item. The right side shows the properties of the selected data item. To select a data item, click the row of the data item in the data item list. The following table describes each property of the data item.

Property	Description
Address	The address of the latest value of the data item.
Name	Specifies the name of the data item for the language specified in the Language field.
Language	Select a language so you can view and edit the name of the data item for that language.
Data Type	The data type of the data item. The supported data types include: 16-Bit Unsigned Integer, 32-Bit Unsigned Integer, 16-Bit Signed Integer, 32-Bit Signed Integer, 16-Bit BCD, 32-Bit BCD, 32-Bit Floating Point, ASCII String, and Unicode String.



Continued

Property	Description																									
Display Type	<p>The display type for the value of the data item. The following table shows the available display types for each data type.</p> <table border="1"> <thead> <tr> <th>Data Type</th> <th>Available Display Types</th> </tr> </thead> <tbody> <tr> <td>16-Bit Unsigned Integer</td> <td>16-Bit Unsigned Decimal, 16-Bit Hexadecimal, 16-Bit Octal</td> </tr> <tr> <td>32-Bit Unsigned Integer</td> <td>32-Bit Unsigned Decimal, 32-Bit Hexadecimal, 32-Bit Octal</td> </tr> <tr> <td>16-Bit Signed Integer</td> <td>16-Bit Signed Decimal</td> </tr> <tr> <td>32-Bit Signed Integer</td> <td>32-Bit Signed Decimal</td> </tr> <tr> <td>16-Bit BCD</td> <td>16-Bit Unsigned Decimal</td> </tr> <tr> <td>32-Bit BCD</td> <td>32-Bit Unsigned Decimal</td> </tr> <tr> <td>32-Bit Floating Point</td> <td>32-Bit Floating Point</td> </tr> <tr> <td>ASCII String</td> <td>ASCII String</td> </tr> <tr> <td>Unicode String</td> <td>Unicode String</td> </tr> </tbody> </table>	Data Type	Available Display Types	16-Bit Unsigned Integer	16-Bit Unsigned Decimal, 16-Bit Hexadecimal, 16-Bit Octal	32-Bit Unsigned Integer	32-Bit Unsigned Decimal, 32-Bit Hexadecimal, 32-Bit Octal	16-Bit Signed Integer	16-Bit Signed Decimal	32-Bit Signed Integer	32-Bit Signed Decimal	16-Bit BCD	16-Bit Unsigned Decimal	32-Bit BCD	32-Bit Unsigned Decimal	32-Bit Floating Point	32-Bit Floating Point	ASCII String	ASCII String	Unicode String	Unicode String					
Data Type	Available Display Types																									
16-Bit Unsigned Integer	16-Bit Unsigned Decimal, 16-Bit Hexadecimal, 16-Bit Octal																									
32-Bit Unsigned Integer	32-Bit Unsigned Decimal, 32-Bit Hexadecimal, 32-Bit Octal																									
16-Bit Signed Integer	16-Bit Signed Decimal																									
32-Bit Signed Integer	32-Bit Signed Decimal																									
16-Bit BCD	16-Bit Unsigned Decimal																									
32-Bit BCD	32-Bit Unsigned Decimal																									
32-Bit Floating Point	32-Bit Floating Point																									
ASCII String	ASCII String																									
Unicode String	Unicode String																									
Total Digits	Specifies the number of digits to be displayed for the value of the data item.																									
Fractional Digits	<p>Specifies how to display the fractional part for the value of the data item. When the Display Type is 32-bit Floating Point, this property specifies the number of fractional digits to be displayed. When the Display Type is not 32-bit Floating Point, this property specifies not only the number of fractional digits to be displayed, but also the number of least significant digits to be displayed as the fractional part. With this feature, an integer can be shown as a fixed point number.</p> <p>Example:</p> <table border="1"> <thead> <tr> <th>Display Type</th> <th>Total Digits</th> <th>Fractional Digits</th> <th>Sampled Value</th> <th>Displayed Value</th> </tr> </thead> <tbody> <tr> <td>32-bit Floating Point</td> <td>4</td> <td>2</td> <td>12.34</td> <td>12.34</td> </tr> <tr> <td>32-bit Floating Point</td> <td>4</td> <td>2</td> <td>123.4</td> <td>23.40</td> </tr> <tr> <td>16-bit Signed Decimal</td> <td>5</td> <td>2</td> <td>12345</td> <td>123.45</td> </tr> <tr> <td>16-bit Signed Decimal</td> <td>5</td> <td>2</td> <td>-5</td> <td>-0.05</td> </tr> </tbody> </table>	Display Type	Total Digits	Fractional Digits	Sampled Value	Displayed Value	32-bit Floating Point	4	2	12.34	12.34	32-bit Floating Point	4	2	123.4	23.40	16-bit Signed Decimal	5	2	12345	123.45	16-bit Signed Decimal	5	2	-5	-0.05
Display Type	Total Digits	Fractional Digits	Sampled Value	Displayed Value																						
32-bit Floating Point	4	2	12.34	12.34																						
32-bit Floating Point	4	2	123.4	23.40																						
16-bit Signed Decimal	5	2	12345	123.45																						
16-bit Signed Decimal	5	2	-5	-0.05																						
Scaling	<p>Check this option if you want the value of the data item to be displayed in a scaled manner. The following is the scaling formula:</p> $\text{DisplayedValue} = \text{SampledValue} * \text{Gain} + \text{Offset}$ <p>Note: The <i>Gain</i> and <i>Offset</i> are 32-bit floating point numbers. They have, at most, 6 significant digits. Rounding and truncation errors may happen.</p>																									
Gain	Available when the Scaling option is checked. Specifies the <i>Gain</i> used in the scaling formula.																									
Offset	Available when the Scaling option is checked. Specifies the <i>Offset</i> used in the scaling formula.																									
Range Check	Check this option if you want the data item to verify the entered value according to the specified minimum and maximum. If the entered value is not within the allowable range, the entered value will not be output.																									
Min	Specifies the minimum value.																									
Max	Specifies the maximum value.																									

10.6. Selecting a Recipe Using Recipe Selectors

10.6.1. Basic Operations

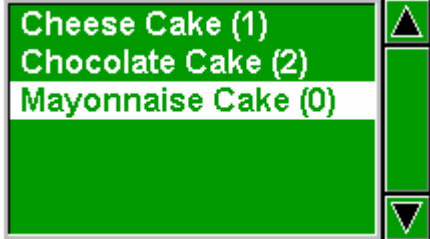
A recipe selector can be configured to perform as one of the following types of controls:

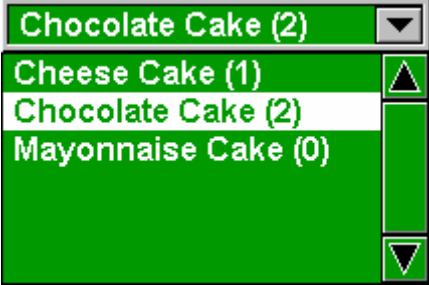
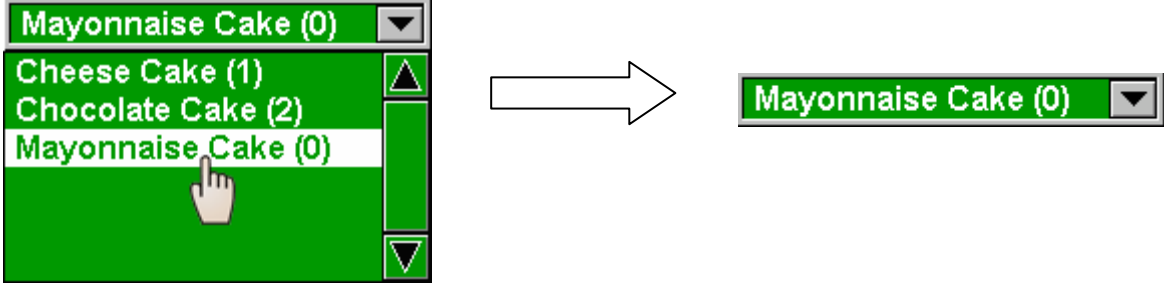
Type	Description
List	<p>The recipe selector is a list box. It displays a list of index strings of the recipes in the specified recipe block. The index string's format is recipe name (recipe number). One recipe index string is displayed per line.</p> <p>The index string of the current recipe is highlighted. If the desired recipe is not in view, you can scroll the list with the scroll bar attached to the right side of the list box. When you select a desired recipe by touching its index string, the recipe selector writes the recipe number of the selected recipe to the current recipe number register.</p> 
Drop-down List	<p>The recipe selector is a drop-down list. It displays the index string of the current recipe and a button with the down arrow symbol as shown.</p>  <p>When the button is touched, the recipe selector displays a list box beneath itself as shown.</p>  <p>The list box lists the index strings of all the recipes of the recipe block, one index string per line. The index string of the current recipe is highlighted. If the desired recipe is not in view, you can use the scroll bar attached to the right side of the list to scroll the index string. When you select a desired recipe by touching its index string, the recipe selector writes the recipe number of the selected recipe to the current recipe number register and closes the list box.</p>  <p>If you want to cancel the operation when the list box is showing, touch anywhere other than an index string in the list box.</p>

10.6.2. Operation Options

The following operation options can be added to a recipe selector. Select and set up the options in the recipe selector property sheet.

Options	Description
Visibility Control	You can show or hide a recipe selector by a specified bit or the current user level. Select and set up this option in the Visibility page.

10.6.3. Settings

You can complete all the settings of a recipe selector in the Recipe Selector property sheet. This sheet contains the following three pages.

- **General**
Described in [Section 10.6.4.](#)
- **Advanced**
Described in [Section 4.4.5.](#)
- **Visibility**
Described in [Section 4.4.6.](#)

10.6.4. General Settings

This section describes how to define the general settings of a recipe selector. The following is an example of the General page.

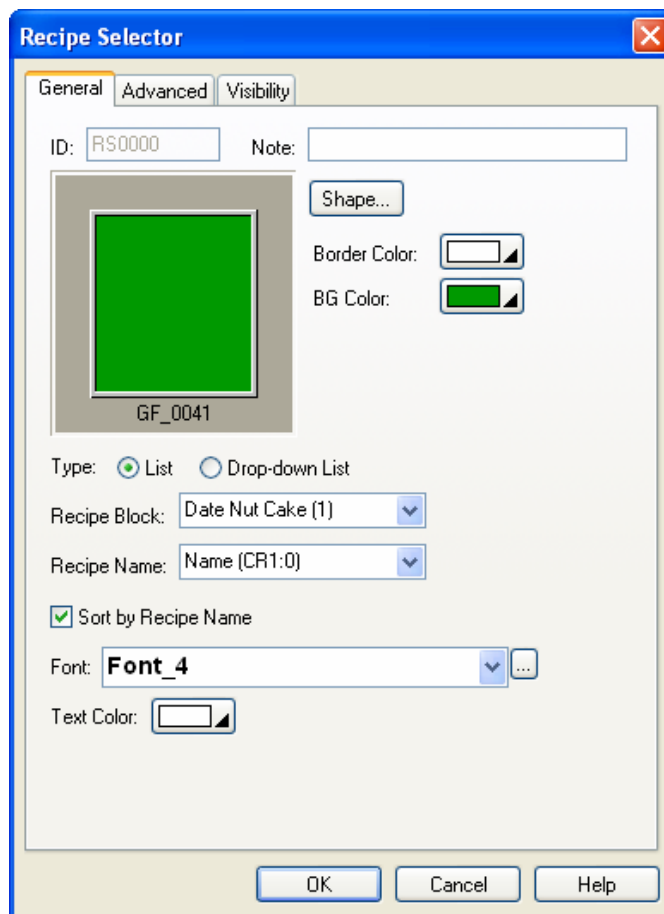
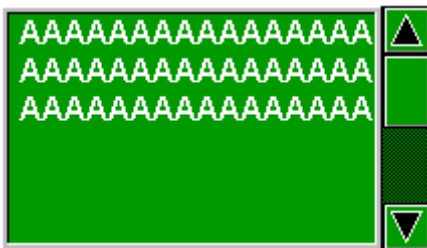

The following table describes each property in the General page.

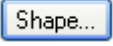
Property	Description						
ID	The object's identifier. It is generated when the object is created and is unchangeable. The identifier is unique within the screen where the object is located. The format of the IDs for the recipe selectors is RSnnnn.						
Note	You can type a note for the object.						
Shape settings	For details about the following properties, Section 4.3.4 Setting up the Shape of an Object.  , Border Color, BG Color						
Type	Select one of the following types for the recipe selector: <table border="1" data-bbox="534 562 1492 719"> <thead> <tr> <th>Type</th> <th>Description</th> </tr> </thead> <tbody> <tr> <td>List</td> <td>The list box is displayed at all times.</td> </tr> <tr> <td>Drop-down List</td> <td>The list box is not displayed unless the user clicks the down arrow icon next to the static-text control.</td> </tr> </tbody> </table>	Type	Description	List	The list box is displayed at all times.	Drop-down List	The list box is not displayed unless the user clicks the down arrow icon next to the static-text control.
Type	Description						
List	The list box is displayed at all times.						
Drop-down List	The list box is not displayed unless the user clicks the down arrow icon next to the static-text control.						
Recipe Block	Select the recipe block whose recipe is to be selected by the Recipe Selector object.						
Recipe Name	Select a data item from the list as the recipe name. You can select any data items with ASCII String data type as the name of the recipe from the drop down list.						
Sort by Recipe Name	Check this option to automatically sort all recipe names added to the list box.						
Font	The font of the displayed string.						
Text Color	The color of the displayed string.						

10.7. Displaying and Modifying Recipe Data Using Recipe Tables

10.7.1. Basic Operations

There are three types of recipe tables.

Type	Description																																				
Horizontal View	<p>Displays the recipes in rows and recipe data items in columns.</p> <table border="1"> <thead> <tr> <th>No.</th> <th>Name</th> <th>Dates & Walnuts</th> <th>Water</th> <th>Butter</th> <th>Sugar</th> <th>Flour</th> <th>Egg</th> <th>Extra</th> </tr> </thead> <tbody> <tr> <td>0</td> <td>Mayonnaise Cake</td> <td>2</td> <td>1.00</td> <td>0.5</td> <td>1.00</td> <td>2.00</td> <td>1</td> <td>1 mayonnaise</td> </tr> <tr> <td>1</td> <td>Cheese Cake</td> <td>2</td> <td>2.00</td> <td>1.5</td> <td>2.25</td> <td>3.00</td> <td>2</td> <td>2t baking soda</td> </tr> <tr> <td>2</td> <td>Chocolate Cake</td> <td>1</td> <td>2.00</td> <td>0.0</td> <td>2.50</td> <td>2.75</td> <td>4</td> <td>2t baking soda</td> </tr> </tbody> </table> <p>The above is an example of the recipe table with horizontal view. The first row displays the data item name of each column. The other rows display one recipe per row. The first column displays the recipe number. You can create scroll button groups or scroll bars to scroll the contents.</p>	No.	Name	Dates & Walnuts	Water	Butter	Sugar	Flour	Egg	Extra	0	Mayonnaise Cake	2	1.00	0.5	1.00	2.00	1	1 mayonnaise	1	Cheese Cake	2	2.00	1.5	2.25	3.00	2	2t baking soda	2	Chocolate Cake	1	2.00	0.0	2.50	2.75	4	2t baking soda
No.	Name	Dates & Walnuts	Water	Butter	Sugar	Flour	Egg	Extra																													
0	Mayonnaise Cake	2	1.00	0.5	1.00	2.00	1	1 mayonnaise																													
1	Cheese Cake	2	2.00	1.5	2.25	3.00	2	2t baking soda																													
2	Chocolate Cake	1	2.00	0.0	2.50	2.75	4	2t baking soda																													
Vertical View	<p>Displays the recipes in columns and recipe data items in rows.</p> <table border="1"> <thead> <tr> <th>No.</th> <th>0</th> <th>1</th> <th>2</th> </tr> </thead> <tbody> <tr> <td>Name</td> <td>Mayonnaise Cake</td> <td>Cheese Cake</td> <td>Chocolate Cake</td> </tr> <tr> <td>Dates & Walnuts</td> <td>2</td> <td>2</td> <td>1</td> </tr> <tr> <td>Water</td> <td>1.00</td> <td>2.00</td> <td>2.00</td> </tr> <tr> <td>Butter</td> <td>0.5</td> <td>1.5</td> <td>0.0</td> </tr> <tr> <td>Sugar</td> <td>1.00</td> <td>2.25</td> <td>2.50</td> </tr> <tr> <td>Flour</td> <td>2.00</td> <td>3.00</td> <td>2.75</td> </tr> <tr> <td>Egg</td> <td>1</td> <td>2</td> <td>4</td> </tr> <tr> <td>Extra</td> <td>1 mayonnaise</td> <td>2t baking soda</td> <td>2t baking soda</td> </tr> </tbody> </table> <p>The above is an example of the recipe table with vertical view. The first column displays the data item name of each row. The other columns display one recipe per column. The first row displays the recipe number. You can create scroll button groups or scroll bars to scroll the contents.</p>	No.	0	1	2	Name	Mayonnaise Cake	Cheese Cake	Chocolate Cake	Dates & Walnuts	2	2	1	Water	1.00	2.00	2.00	Butter	0.5	1.5	0.0	Sugar	1.00	2.25	2.50	Flour	2.00	3.00	2.75	Egg	1	2	4	Extra	1 mayonnaise	2t baking soda	2t baking soda
No.	0	1	2																																		
Name	Mayonnaise Cake	Cheese Cake	Chocolate Cake																																		
Dates & Walnuts	2	2	1																																		
Water	1.00	2.00	2.00																																		
Butter	0.5	1.5	0.0																																		
Sugar	1.00	2.25	2.50																																		
Flour	2.00	3.00	2.75																																		
Egg	1	2	4																																		
Extra	1 mayonnaise	2t baking soda	2t baking soda																																		
Current Recipe	<p>Displays the recipe data items of the current recipe in rows.</p> <table border="1"> <tbody> <tr> <td>Name</td> <td>Mayonnaise Cake</td> </tr> <tr> <td>Dates & Walnuts</td> <td>2</td> </tr> <tr> <td>Water</td> <td>1.00</td> </tr> <tr> <td>Butter</td> <td>0.5</td> </tr> <tr> <td>Sugar</td> <td>1.00</td> </tr> <tr> <td>Flour</td> <td>2.00</td> </tr> <tr> <td>Egg</td> <td>1</td> </tr> <tr> <td>Extra</td> <td>1 mayonnaise</td> </tr> </tbody> </table> <p>The above is an example of the current recipe. The first column displays the data item name of each row. The other column displays the current recipe. You can create scroll button groups or scroll bars to scroll the contents.</p>	Name	Mayonnaise Cake	Dates & Walnuts	2	Water	1.00	Butter	0.5	Sugar	1.00	Flour	2.00	Egg	1	Extra	1 mayonnaise																				
Name	Mayonnaise Cake																																				
Dates & Walnuts	2																																				
Water	1.00																																				
Butter	0.5																																				
Sugar	1.00																																				
Flour	2.00																																				
Egg	1																																				
Extra	1 mayonnaise																																				

10.7.2. Operation Options

The following operation option can be added to a recipe table. Select and set up the option in the recipe table property sheet.

Options	Description
Visibility Control	You can show or hide a recipe table by a specified bit or the current user level. Select and set up this option in the Visibility page.

10.7.3. Settings

You can complete all the settings of a recipe table in the Recipe Table property sheet. This sheet contains the following three pages.

- **General**
Described in [Section 10.7.4.](#)
- **Data Item**
Described in [Section 10.7.5.](#)
- **Visibility**
Described in [Section 4.4.6.](#)

10.7.4. General Settings

This section describes how to define the general settings for a recipe table. The following is an example of the General page.

Name	AAAAAAAAAAAAAAAA
Dates & Walnuts	9999
Water	-99.99
Butter	-999.9
Sugar	-99.99
Flour	-99.99
Egg	9999
Extra	AAAAAAAAAAAAAAAA

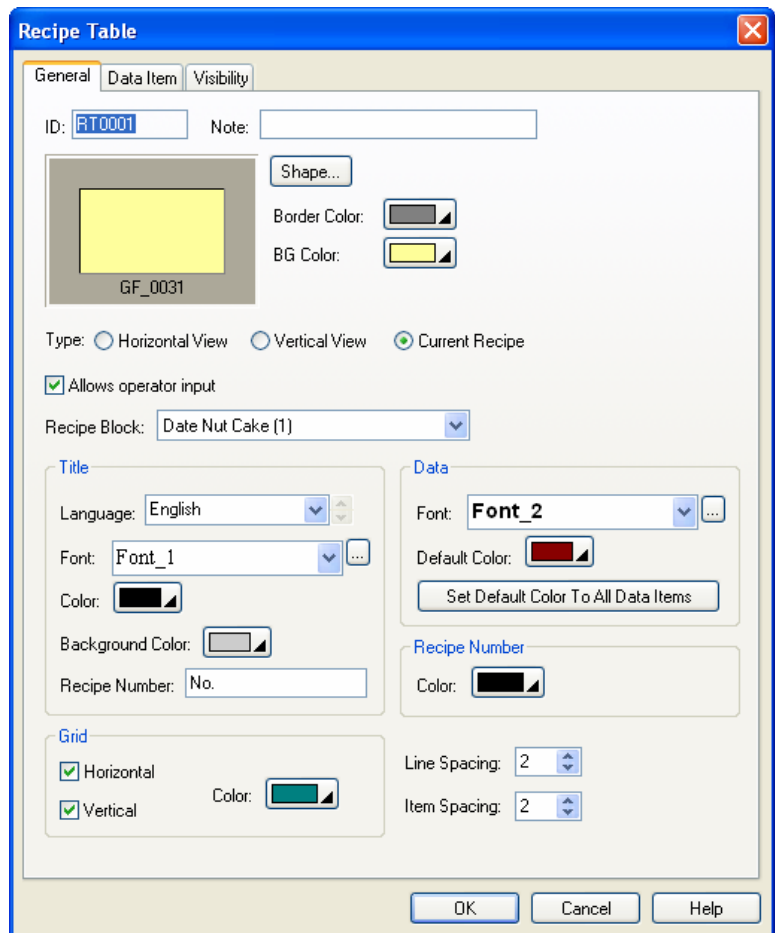

The following table describes each property in the General page.

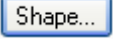
Property		Description								
ID		The object's identifier. It is generated when the object is created and is unchangeable. The identifier is unique within the screen where the object is located. The format of the IDs for the recipe tables is RTnnnn.								
Note		You can type a note for the object.								
Shape settings		For details about the following properties, Section 4.3.4 Setting up the Shape of an Object .  , Border Color, BG Color								
Type		Select one of the following types for the recipe table: <table border="1" data-bbox="533 546 1461 808"> <thead> <tr> <th>Type</th> <th>Description</th> </tr> </thead> <tbody> <tr> <td>Horizontal View</td> <td>Displays the recipes in rows and recipe data items in columns.</td> </tr> <tr> <td>Vertical View</td> <td>Displays the recipes in columns and recipe data items in rows.</td> </tr> <tr> <td>Current Recipe</td> <td>Displays the recipe data items of the current recipe in rows.</td> </tr> </tbody> </table>	Type	Description	Horizontal View	Displays the recipes in rows and recipe data items in columns.	Vertical View	Displays the recipes in columns and recipe data items in rows.	Current Recipe	Displays the recipe data items of the current recipe in rows.
Type	Description									
Horizontal View	Displays the recipes in rows and recipe data items in columns.									
Vertical View	Displays the recipes in columns and recipe data items in rows.									
Current Recipe	Displays the recipe data items of the current recipe in rows.									
Allows operator input		Check this option if you allow the operator to update the value of the recipe data item.								
Recipe Block		Select the recipe whose collected data is to be displayed by the object.								
Title	Language	Select a language so you can view and edit the settings of the title row for that language.								
	Font	Select a font for the title text.								
	Color	Select a color for the title text.								
	Background Color	Select a color for the background of the title row.								
	Recipe Number	Specifies the title for the recipe number column.								
Grid	Vertical	Check this option if you want the object to have vertical grids.								
	Horizontal	Check this option if you want the object to have horizontal grids.								
	Color	Select a color for the grids.								
Data	Font	Select a font for displaying data.								
	Default Color	Select a color as the default color for displaying data.								
	Set Default Color to All Data Items	Click this button to set the colors of all the data items to the Default Color.								
Recipe Number	Color	Select a color for the recipe number.								
Line Spacing		Specifies the extra space in pixels for two adjacent rows in the table.								
Item Spacing		Specifies the extra space for every column in the table.								

10.7.5. Data Item Settings

This section describes how to define the display format for the values of each data item. The following is an example of the Data Item page.

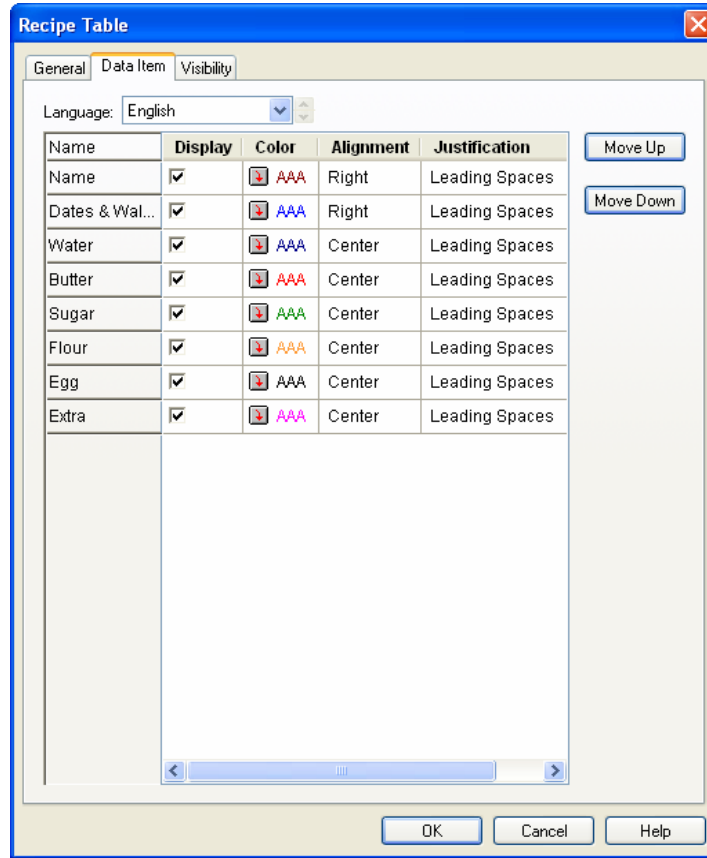

The following table describes each property in the Data Item page.

Property		Description							
Language		Select a language so you can view and edit the settings for that language.							
Row #n of the property table	Name	The name of data item #n. The data item names are defined in the Data Item page of the Data Logger dialog box.							
	Display	Check this option if you want the object to display data item #n.							
	Color	Select a color for displaying data item #n.							
	Alignment	The alignment for displaying data item #n. There are three types of alignments: Left, Center, and Right.							
	Justification	The justification for displaying data item #n. There are three types of justifications: <table border="1" style="width: 100%; margin-top: 5px;"> <thead> <tr> <th>Option</th> <th>Description</th> </tr> </thead> <tbody> <tr> <td>Zero Suppress</td> <td>The leading digits will not display when they are 0.</td> </tr> <tr> <td>Leading Zeros</td> <td>All digits will display.</td> </tr> <tr> <td>Leading Spaces</td> <td>The leading digits will display as blank characters when they are 0.</td> </tr> </tbody> </table>	Option	Description	Zero Suppress	The leading digits will not display when they are 0.	Leading Zeros	All digits will display.	Leading Spaces
Option	Description								
Zero Suppress	The leading digits will not display when they are 0.								
Leading Zeros	All digits will display.								
Leading Spaces	The leading digits will display as blank characters when they are 0.								
Move Up		Click the button to move the selected data item before the previous data item. The Move Up button will help you to reorder the display sequence of the data items. It will not be available when multiple rows are selected or no row is selected.							
Move Down		Click the button to move the selected data item after the next data item. The Move Down button will help you to reorder the display sequence of the data items. It will not be available when multiple rows are selected or no row is selected.							

CHAPTER 10

RECIPES AND RECIPE OBJECTS

10.1. Recipes	1
10.2. Recipe Data Flow and Memory Allocation	2
10.3. Working with Recipes	3
10.4. Transferring Recipes	4
10.4.1. Between the PC and HMI	4
10.4.2. Between the HMI and USB Memory Stick/Micro SD Card	4
10.4.3. Between the battery backed memory and flash ROM	4
10.4.4. Between the HMI and PLC/Controller	5
10.5. Setting up Recipe Blocks.....	6
10.5.1. General Settings.....	6
10.5.2. Data Item Settings.....	9
10.6. Selecting a Recipe Using Recipe Selectors	11
10.6.1. Basic Operations	11
10.6.2. Operation Options.....	12
10.6.3. Settings	12
10.6.4. General Settings.....	12
10.7. Displaying and Modifying Recipe Data Using Recipe Tables	14
10.7.1. Basic Operations	14
10.7.2. Operation Options.....	15
10.7.3. Settings	15
10.7.4. General Settings.....	15
10.7.5. Data Item Settings.....	17

In this chapter we will explain how recipes in the software can be set up, stored and transferred. We also describe how to configure the basic functions and recipe objects (recipe selector and recipe table) used for recipes.

10.1. Recipes

■ Recipe Block

A recipe block is a memory block that stores recipe data as a two dimensional array in the panel. The memory size of each recipe block is the product of the size of a recipe by the number of recipes in word. You can create up to 16 recipe blocks for your application. Each recipe block can contain at most 65535 recipes. Each recipe can have as many as 4096 words of data.

■ Recipe

A recipe is a group of data items. You can use a recipe number or a recipe name to index a recipe in the corresponding recipe block.

The recipe number is a unique number between 0 and the total number of recipes. The current recipe number of the recipe block m is saved in the current recipe number register \$RNm (m: The recipe block ID).

The recipe name can be represented by ASCII or Unicode String. To specify ASCII or Unicode String as the recipe name, you need to open the dialog box of a recipe block and set the data type of the related data item into ASCII or Unicode String in the data item page. For details about recipe data item settings, please see [Section 10.5.2](#).

■ Recipe Data Item

A data item is a word or words of data used to represent an application related data or a machine setup parameter used in process and production control. You can specify the format such as name, data type, size, scaling and range check for each data item in the recipe block dialog box.

The following is a sample of a recipe block with 3 recipes and each recipe has 8 data items.

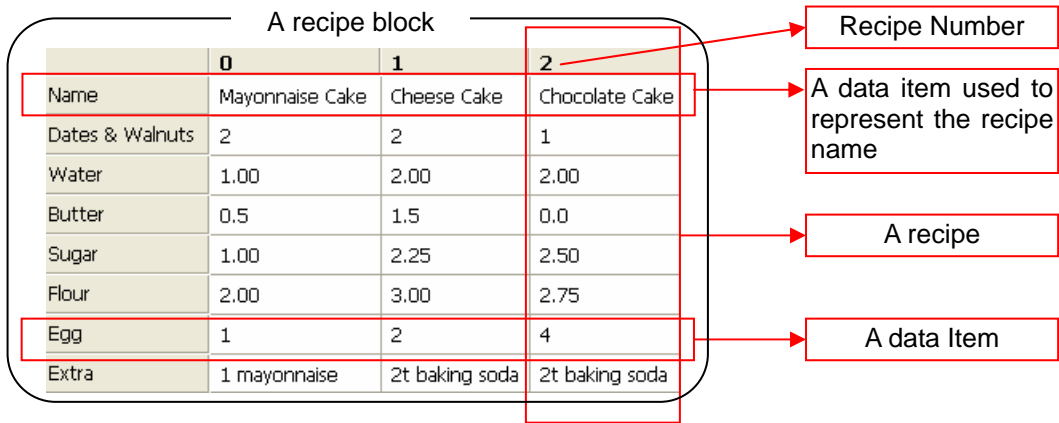

■ Recipe Data

There are two types of recipe data: TXT Data and PRD Data. These recipes can be transferred directly between the PC and HMI or between the HMI and USB Memory Stick/Micro SD card.

Recipe Data	Description
TXT Data	<ul style="list-style-type: none"> Can be created and edited in Microsoft Excel or text editor software (e.g., Notepad)
PRD Data	<ul style="list-style-type: none"> Binary Data created in the software Can be edited in RecipeEditor

10.2. Recipe Data Flow and Memory Allocation

Assume there are two recipe blocks (Recipe Block 0 and Recipe Block 9) in an application. Recipe Block 0 has 3 recipes and each recipe has 4 data items named A, B, C and D. Recipe Block 9 has 2 recipes and each recipe has 3 data items named E, F and G.

The following illustration gives an overview of recipe data flow and recipe memory allocation.

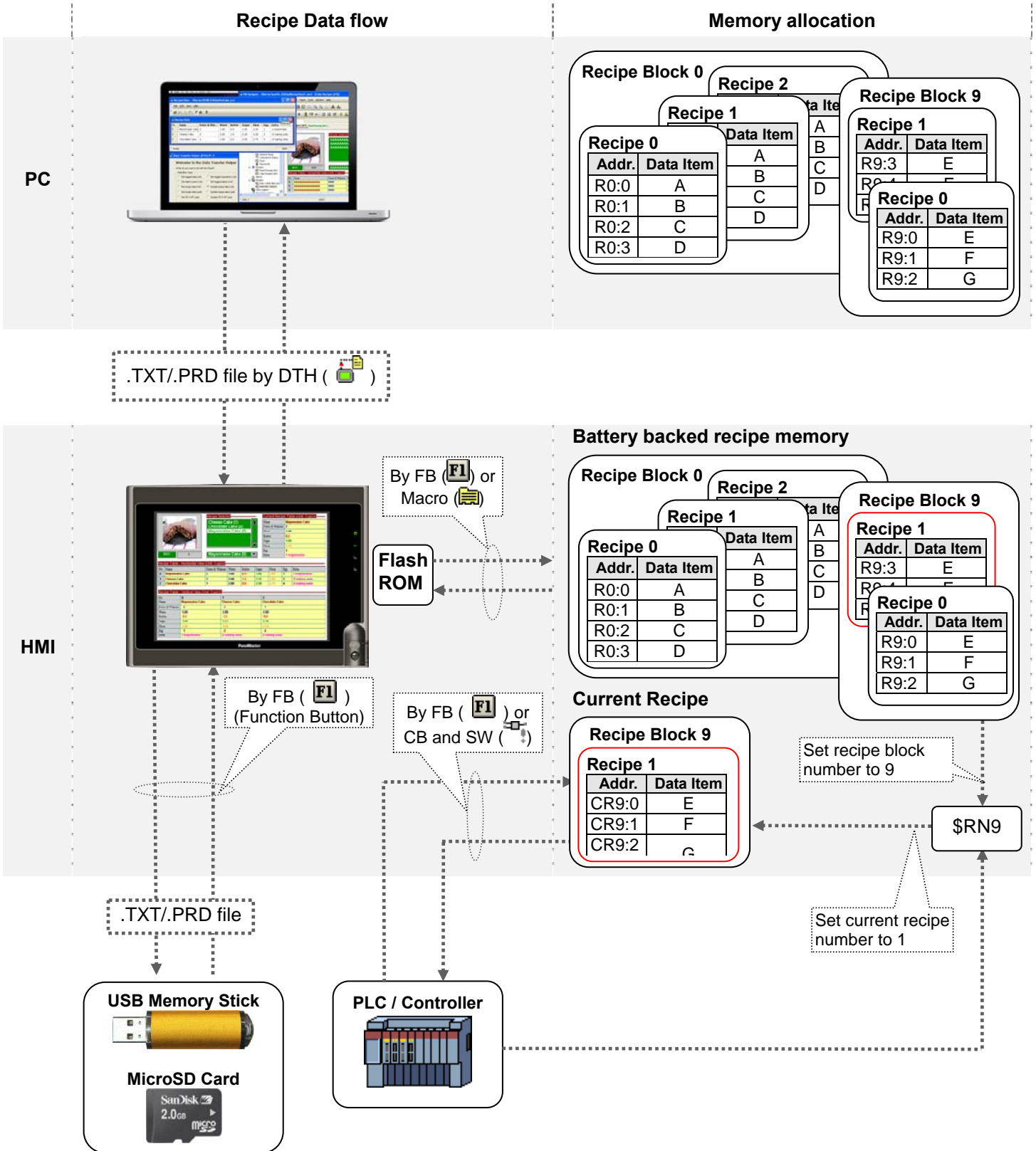

10.3. Working with Recipes

To work with recipes, you need to do the following:

■ **Create and set up a recipe block**

To create a recipe block, you may do one of the following:

- 1) In the Project Manager tool window, right-click the Recipes node of the concerned panel application and select Add Recipe Block.
- 2) In the menu bar, click Panel to bring up the Panel sub-menu. Click Recipe Block in the Panel sub-menu to bring up the Recipe Block pop-up menu. Select Add in the pop-up menu.

For details about how to set up a recipe block, please see [Section 10.5](#).

■ **View and edit recipe data on a PC**

On a PC, you can use RecipeEditor to view and edit recipe data saved in *.prd file. The following is an example of the RecipeEditor.

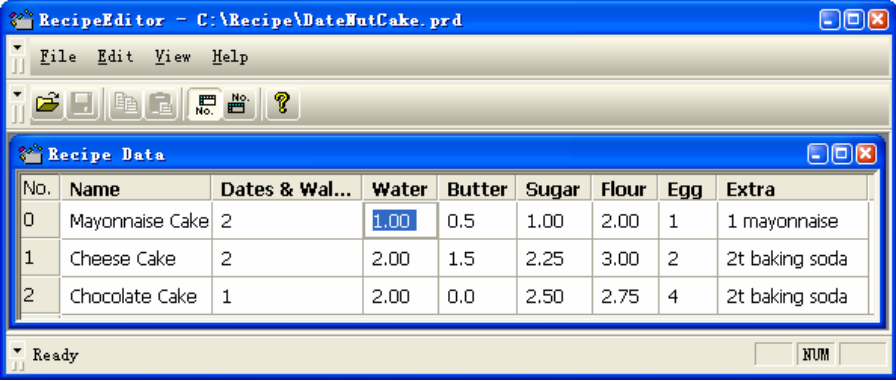

▶▶ To run the RecipeEditor, choose Start > Programs > "The software" > RecipeEditor.

▶▶ To edit recipe data directly in the cell, right click the cell and key in the value you want. Note that any value not matched with the predefined format will cause an error when using the recipe at runtime.

■ **View and edit recipe data on a HMI**

On a HMI, you can use a recipe table to view and edit recipe data. For details about how to create and set up a recipe table for an application, please see [Section 10.7](#).

■ **Select a recipe on HMI**

On a HMI, you can select a recipe by using recipe selector. For details about how to create and set up a recipe selector for an application, please see [Section 10.6](#).

■ **Transfer recipes**

Described in [Section 10.4](#)

10.4. Transferring Recipes

10.4.1. Between the PC and HMI

■ Using Data Transfer Helper (DTH) ()

You can use DTH to download recipe data in *.prd/*.txt file from a PC to a HMI. With DTH, you can also get recipe data from a HMI and save the data in *.prd/*.txt file on to a PC. The following is an example of the Data Transfer Helper (DTH) used to get or update recipe data.

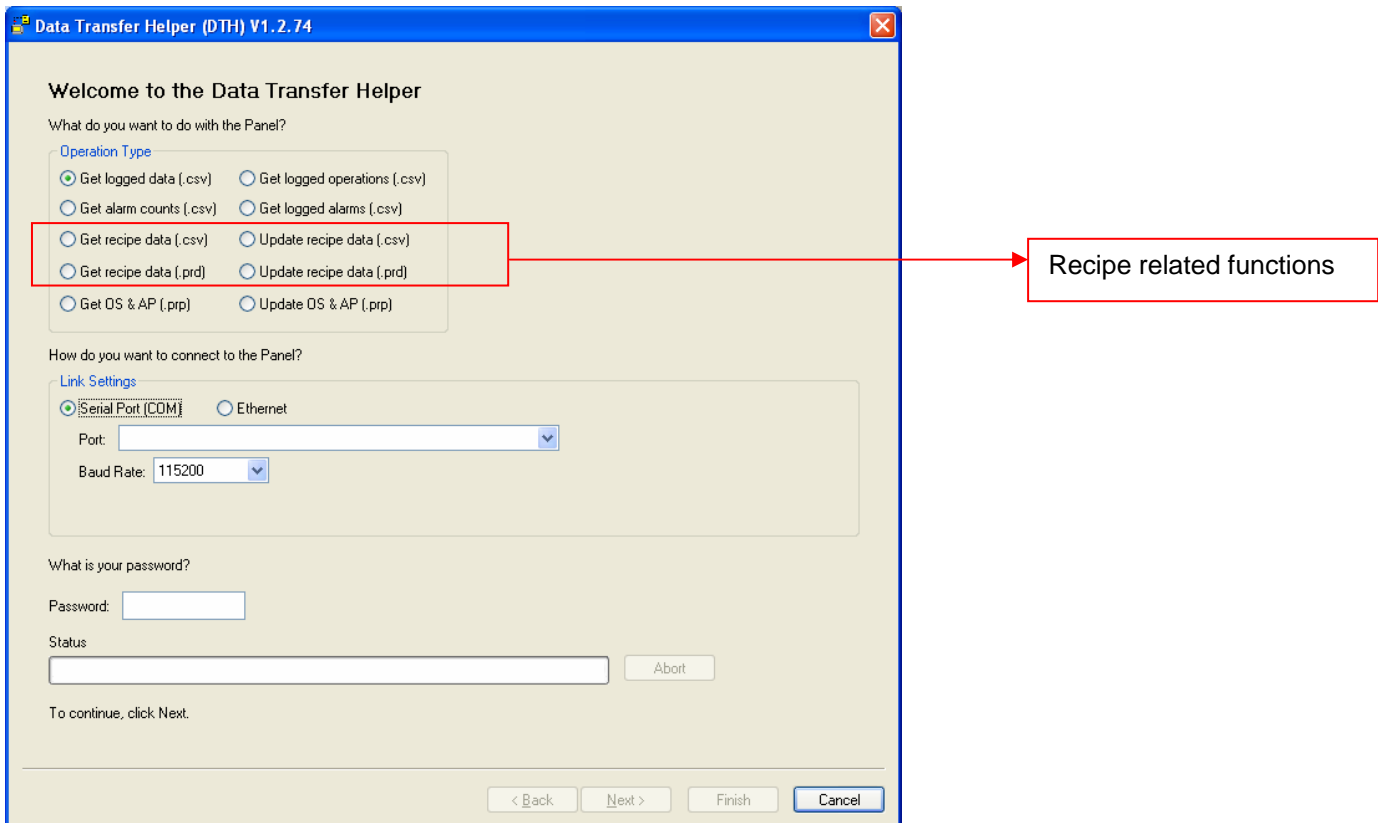

To run the DTH, choose Start > Programs > “The software” >  Data Transfer Helper (DTH).

10.4.2. Between the HMI and USB Memory Stick/Micro SD Card

■ Using the Function Button ()

You can use a function button to save recipe data of the specified recipe block as a .txt\prd file, or load recipe data of the specified recipe block from a .txt\prd file. For details, please see [Section 5.4.1 Basic Operations](#) of function buttons

10.4.3. Between the battery backed memory and flash ROM

■ Using Macro Command ()

You can use RB2ROM to save the data of the specified recipe block to a flash ROM, and use ROM2RB to load recipe data from a flash ROM. For details, please see [Section 5.4.1 Basic Operations](#) of Macro command

■ Using Function Button ()

You can use a function button to save recipe data to a flash ROM, and load recipe data from a flash ROM. For details, please see [Section 5.4.1 Basic Operations](#) of function buttons

10.4.4. Between the HMI and PLC/Controller

■ Using Command Block and Status Words ()

You can use the command flag setting in Command Block to request the panel to set the current recipe number, read a recipe from a PLC or write a recipe to a PLC. You can also receive current the recipe block ID or current recipe number by checking the related status word and specifying the word variable in Status Words. For details, please see [Section 3.5.1 Command Block and Status Words](#).

To change the current recipe number, the PLC first sets the Parameter Two Register to the desired recipe block and the Parameter One Register to the desired recipe number, then turns on the Set Current Recipe Number (#2) command flag. Also, \$RNm (Current Recipe Number Register, m: Recipe Block ID) of the panel can be changed by the PLC.

To update a recipe in the panel, the PLC first sets the Parameter Two Register to the desired recipe block and the Parameter One Register to the desired recipe number, then turns on the Read Recipe From PLC (#3) command flag. The panel reads data in the Recipe Block to update the specified recipe in the panel.

To receive a recipe, the PLC first sets the Parameter Two Register to the desired recipe block and the Parameter One Register to the desired recipe number, then turns on the Write Recipe To PLC (#4) command flag. The panel sends the specified recipe data to the Recipe Block in the PLC.

Note: You do not need to specify the recipe block if the application has only one recipe block.

Note: To make the above operation work, the specified recipe block must exist, or else the panel ignores the request. The specified recipe number in the Parameter One Register must be between 0 and the maximum recipe number - 1. If the Parameter One Register is greater than or equal to the maximum recipe number, the panel ignores the request.

■ Using the Function Button ()

You can use a function button to write the current recipe to the controller, or update current the recipe by reading the recipe from the controller. For details, please see [Section 5.4.1 Basic Operations](#) of function buttons

10.5. Setting up Recipe Blocks

You can set up a recipe block with the Recipe Block dialog box. There are two ways to open the dialog box of a recipe block:

- 1) In the Project Manager window, right-click the node of the desired Recipe Block and select Properties.
- 2) In the menu bar, click Panel to bring up the Panel sub-menu. Click Recipes in the Panel sub-menu to bring up the Recipe Block pop-up menu. Select Properties in the pop-up menu to bring up the recipe block list of the current panel application. Select the recipe block in the list.

The Recipe Block dialog box contains the following two pages:

- **General**

Described in [Section 10.5.1](#).

- **Data Item**

Described in [Section 10.5.2](#).

10.5.1. General Settings

Use the General page to define the general settings for a recipe block. The following is an example of the General page.

Recipe Block

General | Data Item

Name: ID:

Recipe Size: words Number Of Recipes:

Memory Required: words

Write Recipe To PLC

Write Address:

Notification Bit:

Read Recipe From PLC Read Address Identical To Write Address

Read Address:

Notification Bit:

Read/Write Size: words

Reverse the order of the high word and low word of 32-bit data

Recipe Memory

Bit Address Range:

Word Address Range:

Current Recipe









Bit Address Range:

Word Address Range:

Current Recipe Number Register:

OK Cancel Help

The table below describes each property in the General page.

Property	Description									
Name	The recipe block's name. The maximum length of the name is 48 characters.									
ID	The recipe block's ID number. Select a number between 0 and 15. The number is unique among all recipe blocks of the panel application.									
Recipe Size	Specifies the data size that each recipe contains. The unit is word.									
Number of Recipes	Specifies the maximum number of recipes that the recipe memory can hold.									
Memory Required	The size of the recipe memory. The unit is word. The formula to calculate the size is: $\text{Memory Required} = \text{Recipe Size} * \text{Number of Recipes}$									
Write Recipe To PLC	Check the option if you want to write the recipe to PLC									
Write Address	Available when Write Recipe To PLC is checked. Specifies the variable that is the starting address of the Recipe Block in your PLC. Click  to enter an address for this field. Click  to select a tag for this field. The size of the recipes to be written is specified in the Read/Write Size field.									
Notification	Check this option if you want the recipe to set the bit specified in the Bit Field to On when it finishes writing a recipe to PLC.									
Bit	Available when the Notification field is checked. Specifies the bit for the operation done notification. Click  to enter an address for this field. Click  to select a tag for this field.									
Read Recipe From PLC	Check this option if you want to read recipes from PLC.									
Read Address Identical To Write Address	Specifies that the Read Address is identical to the Write Address. With this item checked, you don't need to specify the Read Address again. This item is available when the option Read Recipe From PLC is checked.									
Read Address	Available when Read Recipe From PLC is checked. Specifies the variable representing the starting address of the recipe block on your PLC. Click  to enter an address for this field. Click  to select a tag for this field. The size of the recipes to be read is specified in the Read/Write Size field.									
Notification	Check the option if you want the recipe to set the bit specified in the Bit Field to On when it finishes reading a recipe from PLC.									
Bit	Available when the Notification field is checked. Specifies the bit for the operation done notification. Click  to enter an address for this field. Click  to select a tag for this field.									
Read/Write Size	The size of the recipe for reading and writing.									
Reverse the order of the high word and low word of 32-bit data	Check this option if the Write Address or the Read Address belongs to a controller that stores data in big-endian byte order and if there are 32-bit data items, such as 32-bit signed integers and 32-bit floating point numbers, defined in the recipe block.									
Recipe Memory	Set the overall recipe block's address range in the internal memory of the panel. <table border="1" data-bbox="478 1644 1481 1861"> <thead> <tr> <th>Range Type</th> <th>Address Format</th> <th>Description</th> </tr> </thead> <tbody> <tr> <td>Bit Address Range</td> <td>\$Rm:n.b b: 0-f</td> <td>Each bit address in the range refers to a bit of a recipe word in the specified recipe block.</td> </tr> <tr> <td>Word Address Range</td> <td>\$Rm:n</td> <td>Each word address in the range refers to a recipe word</td> </tr> </tbody> </table> <p>Legend: m = Recipe Block ID, n = The Number of Recipe Word, b = Bit Number</p>	Range Type	Address Format	Description	Bit Address Range	\$Rm:n.b b: 0-f	Each bit address in the range refers to a bit of a recipe word in the specified recipe block.	Word Address Range	\$Rm:n	Each word address in the range refers to a recipe word
Range Type	Address Format	Description								
Bit Address Range	\$Rm:n.b b: 0-f	Each bit address in the range refers to a bit of a recipe word in the specified recipe block.								
Word Address Range	\$Rm:n	Each word address in the range refers to a recipe word								

Continued

Property	Description		
Current Recipe	Set the current recipe's address range in the internal memory of the panel.		
	Range Type	Address Format	Description
	Bit Address Range	\$CRm:n.b b: 0-f	Each bit address in the range refers to a bit of a recipe word in the current recipe of the specified recipe block.
	Word Address Range	\$CRm:n	Each word address in the range refers to a recipe word in the current recipe of the specified recipe block.
Current Recipe Number Register	\$RNm	An internal register of the panel that specifies the current recipe number of the specified recipe block.	
Legend: m = Recipe Block ID, n = The Number of Recipe Word, b = Bit Number.			
Need space in flash ROM to save backup	Check this option if you need space in the flash ROM to save backup recipes.		
Do not use battery backed RAM	Check this option so the recipe memory will be located in the ordinary RAM, and the recipe memory will be cleared whenever the target panel is powered up. If this option is not selected, so the recipe memory will be located in the battery backed RAM. The recipe data will not be lost after power down if the battery backed RAM is used.		

10.5.2. Data Item Settings

Use the Data Item page to define the data items of the data for a recipe block. The following is an example of the Data Item page.

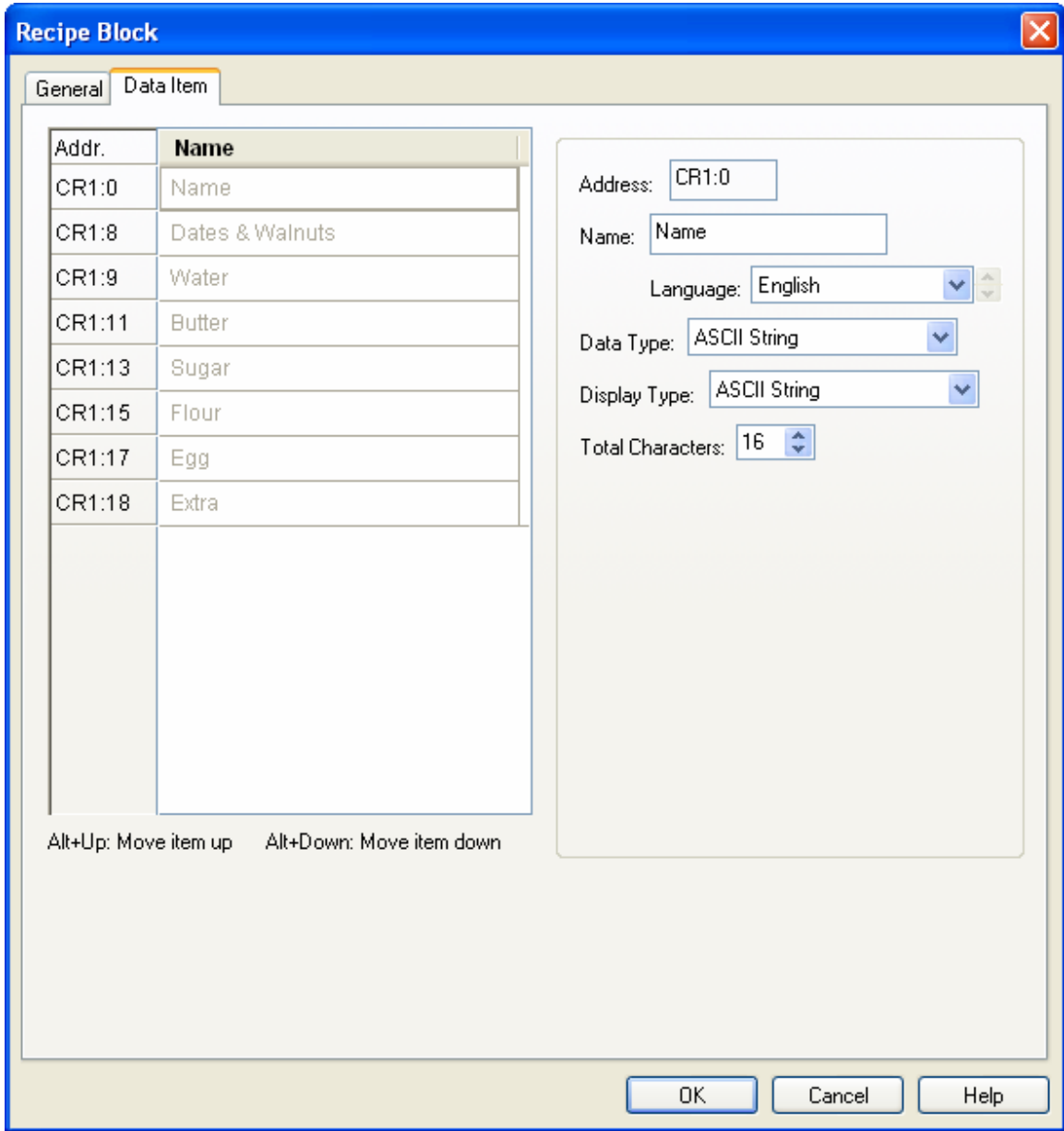

The Data Item page contains two parts. The left side of the data item list shows the address and name of each data item. The right side shows the properties of the selected data item. To select a data item, click the row of the data item in the data item list. The following table describes each property of the data item.

Property	Description
Address	The address of the latest value of the data item.
Name	Specifies the name of the data item for the language specified in the Language field.
Language	Select a language so you can view and edit the name of the data item for that language.
Data Type	The data type of the data item. The supported data types include: 16-Bit Unsigned Integer, 32-Bit Unsigned Integer, 16-Bit Signed Integer, 32-Bit Signed Integer, 16-Bit BCD, 32-Bit BCD, 32-Bit Floating Point, ASCII String, and Unicode String.



Continued

Property	Description																									
Display Type	<p>The display type for the value of the data item. The following table shows the available display types for each data type.</p> <table border="1"> <thead> <tr> <th>Data Type</th> <th>Available Display Types</th> </tr> </thead> <tbody> <tr> <td>16-Bit Unsigned Integer</td> <td>16-Bit Unsigned Decimal, 16-Bit Hexadecimal, 16-Bit Octal</td> </tr> <tr> <td>32-Bit Unsigned Integer</td> <td>32-Bit Unsigned Decimal, 32-Bit Hexadecimal, 32-Bit Octal</td> </tr> <tr> <td>16-Bit Signed Integer</td> <td>16-Bit Signed Decimal</td> </tr> <tr> <td>32-Bit Signed Integer</td> <td>32-Bit Signed Decimal</td> </tr> <tr> <td>16-Bit BCD</td> <td>16-Bit Unsigned Decimal</td> </tr> <tr> <td>32-Bit BCD</td> <td>32-Bit Unsigned Decimal</td> </tr> <tr> <td>32-Bit Floating Point</td> <td>32-Bit Floating Point</td> </tr> <tr> <td>ASCII String</td> <td>ASCII String</td> </tr> <tr> <td>Unicode String</td> <td>Unicode String</td> </tr> </tbody> </table>	Data Type	Available Display Types	16-Bit Unsigned Integer	16-Bit Unsigned Decimal, 16-Bit Hexadecimal, 16-Bit Octal	32-Bit Unsigned Integer	32-Bit Unsigned Decimal, 32-Bit Hexadecimal, 32-Bit Octal	16-Bit Signed Integer	16-Bit Signed Decimal	32-Bit Signed Integer	32-Bit Signed Decimal	16-Bit BCD	16-Bit Unsigned Decimal	32-Bit BCD	32-Bit Unsigned Decimal	32-Bit Floating Point	32-Bit Floating Point	ASCII String	ASCII String	Unicode String	Unicode String					
Data Type	Available Display Types																									
16-Bit Unsigned Integer	16-Bit Unsigned Decimal, 16-Bit Hexadecimal, 16-Bit Octal																									
32-Bit Unsigned Integer	32-Bit Unsigned Decimal, 32-Bit Hexadecimal, 32-Bit Octal																									
16-Bit Signed Integer	16-Bit Signed Decimal																									
32-Bit Signed Integer	32-Bit Signed Decimal																									
16-Bit BCD	16-Bit Unsigned Decimal																									
32-Bit BCD	32-Bit Unsigned Decimal																									
32-Bit Floating Point	32-Bit Floating Point																									
ASCII String	ASCII String																									
Unicode String	Unicode String																									
Total Digits	Specifies the number of digits to be displayed for the value of the data item.																									
Fractional Digits	<p>Specifies how to display the fractional part for the value of the data item. When the Display Type is 32-bit Floating Point, this property specifies the number of fractional digits to be displayed. When the Display Type is not 32-bit Floating Point, this property specifies not only the number of fractional digits to be displayed, but also the number of least significant digits to be displayed as the fractional part. With this feature, an integer can be shown as a fixed point number.</p> <p>Example:</p> <table border="1"> <thead> <tr> <th>Display Type</th> <th>Total Digits</th> <th>Fractional Digits</th> <th>Sampled Value</th> <th>Displayed Value</th> </tr> </thead> <tbody> <tr> <td>32-bit Floating Point</td> <td>4</td> <td>2</td> <td>12.34</td> <td>12.34</td> </tr> <tr> <td>32-bit Floating Point</td> <td>4</td> <td>2</td> <td>123.4</td> <td>23.40</td> </tr> <tr> <td>16-bit Signed Decimal</td> <td>5</td> <td>2</td> <td>12345</td> <td>123.45</td> </tr> <tr> <td>16-bit Signed Decimal</td> <td>5</td> <td>2</td> <td>-5</td> <td>-0.05</td> </tr> </tbody> </table>	Display Type	Total Digits	Fractional Digits	Sampled Value	Displayed Value	32-bit Floating Point	4	2	12.34	12.34	32-bit Floating Point	4	2	123.4	23.40	16-bit Signed Decimal	5	2	12345	123.45	16-bit Signed Decimal	5	2	-5	-0.05
Display Type	Total Digits	Fractional Digits	Sampled Value	Displayed Value																						
32-bit Floating Point	4	2	12.34	12.34																						
32-bit Floating Point	4	2	123.4	23.40																						
16-bit Signed Decimal	5	2	12345	123.45																						
16-bit Signed Decimal	5	2	-5	-0.05																						
Scaling	<p>Check this option if you want the value of the data item to be displayed in a scaled manner. The following is the scaling formula:</p> $\text{DisplayedValue} = \text{SampledValue} * \text{Gain} + \text{Offset}$ <p>Note: The <i>Gain</i> and <i>Offset</i> are 32-bit floating point numbers. They have, at most, 6 significant digits. Rounding and truncation errors may happen.</p>																									
Gain	Available when the Scaling option is checked. Specifies the <i>Gain</i> used in the scaling formula.																									
Offset	Available when the Scaling option is checked. Specifies the <i>Offset</i> used in the scaling formula.																									
Range Check	Check this option if you want the data item to verify the entered value according to the specified minimum and maximum. If the entered value is not within the allowable range, the entered value will not be output.																									
Min	Specifies the minimum value.																									
Max	Specifies the maximum value.																									

10.6. Selecting a Recipe Using Recipe Selectors

10.6.1. Basic Operations

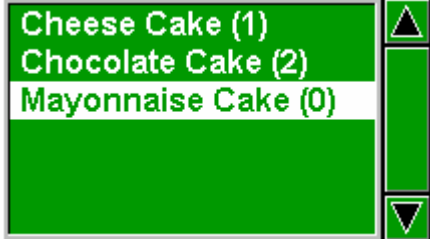
A recipe selector can be configured to perform as one of the following types of controls:

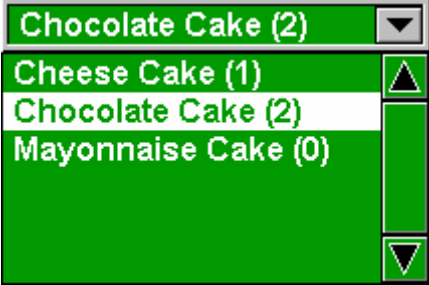
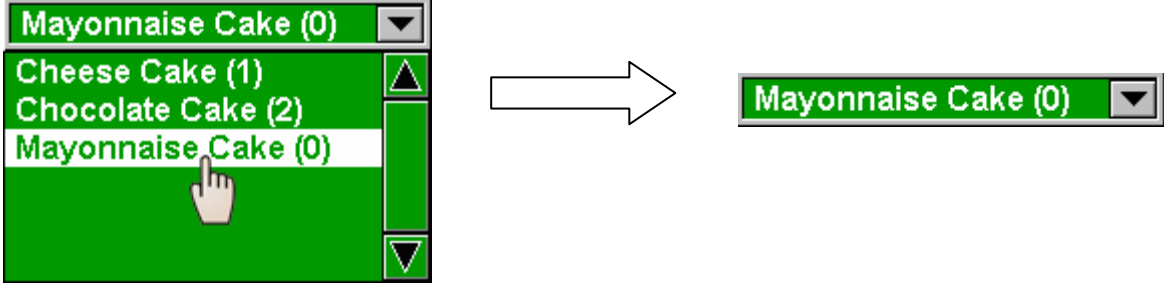
Type	Description
List	<p>The recipe selector is a list box. It displays a list of index strings of the recipes in the specified recipe block. The index string's format is recipe name (recipe number). One recipe index string is displayed per line.</p> <p>The index string of the current recipe is highlighted. If the desired recipe is not in view, you can scroll the list with the scroll bar attached to the right side of the list box. When you select a desired recipe by touching its index string, the recipe selector writes the recipe number of the selected recipe to the current recipe number register.</p> 
Drop-down List	<p>The recipe selector is a drop-down list. It displays the index string of the current recipe and a button with the down arrow symbol as shown.</p>  <p>When the button is touched, the recipe selector displays a list box beneath itself as shown.</p>  <p>The list box lists the index strings of all the recipes of the recipe block, one index string per line. The index string of the current recipe is highlighted. If the desired recipe is not in view, you can use the scroll bar attached to the right side of the list to scroll the index string. When you select a desired recipe by touching its index string, the recipe selector writes the recipe number of the selected recipe to the current recipe number register and closes the list box.</p>  <p>If you want to cancel the operation when the list box is showing, touch anywhere other than an index string in the list box.</p>

10.6.2. Operation Options

The following operation options can be added to a recipe selector. Select and set up the options in the recipe selector property sheet.

Options	Description
Visibility Control	You can show or hide a recipe selector by a specified bit or the current user level. Select and set up this option in the Visibility page.

10.6.3. Settings

You can complete all the settings of a recipe selector in the Recipe Selector property sheet. This sheet contains the following three pages.

- **General**
Described in [Section 10.6.4.](#)
- **Advanced**
Described in [Section 4.4.5.](#)
- **Visibility**
Described in [Section 4.4.6.](#)

10.6.4. General Settings

This section describes how to define the general settings of a recipe selector. The following is an example of the General page.

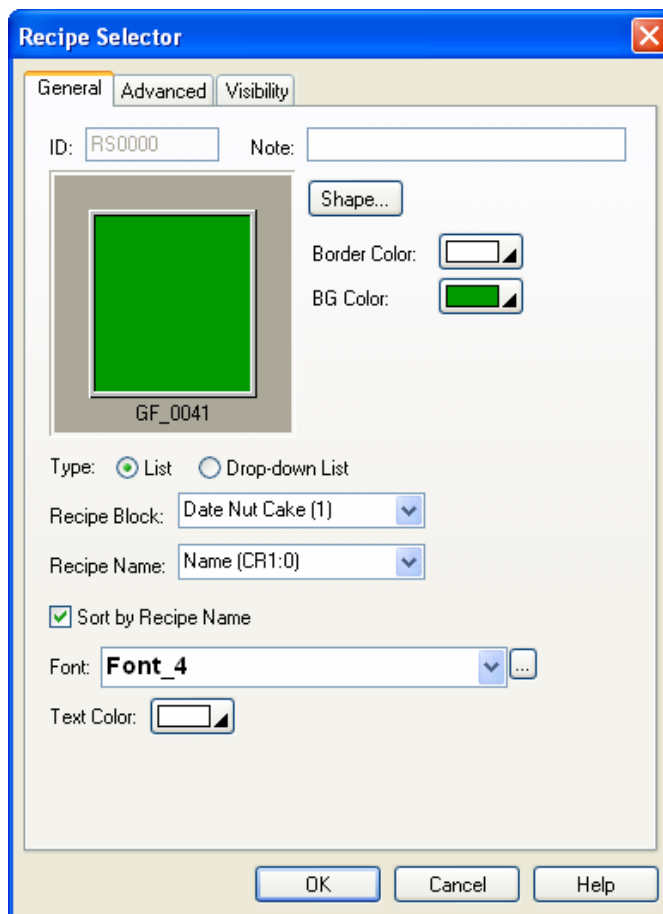
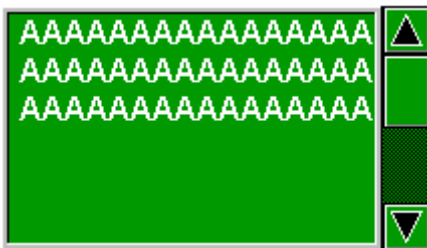

The following table describes each property in the General page.

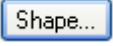
Property	Description						
ID	The object's identifier. It is generated when the object is created and is unchangeable. The identifier is unique within the screen where the object is located. The format of the IDs for the recipe selectors is RSnnnn.						
Note	You can type a note for the object.						
Shape settings	For details about the following properties, Section 4.3.4 Setting up the Shape of an Object.  , Border Color, BG Color						
Type	Select one of the following types for the recipe selector: <table border="1" data-bbox="534 562 1492 719"> <thead> <tr> <th>Type</th> <th>Description</th> </tr> </thead> <tbody> <tr> <td>List</td> <td>The list box is displayed at all times.</td> </tr> <tr> <td>Drop-down List</td> <td>The list box is not displayed unless the user clicks the down arrow icon next to the static-text control.</td> </tr> </tbody> </table>	Type	Description	List	The list box is displayed at all times.	Drop-down List	The list box is not displayed unless the user clicks the down arrow icon next to the static-text control.
Type	Description						
List	The list box is displayed at all times.						
Drop-down List	The list box is not displayed unless the user clicks the down arrow icon next to the static-text control.						
Recipe Block	Select the recipe block whose recipe is to be selected by the Recipe Selector object.						
Recipe Name	Select a data item from the list as the recipe name. You can select any data items with ASCII String data type as the name of the recipe from the drop down list.						
Sort by Recipe Name	Check this option to automatically sort all recipe names added to the list box.						
Font	The font of the displayed string.						
Text Color	The color of the displayed string.						

10.7. Displaying and Modifying Recipe Data Using Recipe Tables

10.7.1. Basic Operations

There are three types of recipe tables.

Type	Description																																				
Horizontal View	<p>Displays the recipes in rows and recipe data items in columns.</p> <table border="1"> <thead> <tr> <th>No.</th> <th>Name</th> <th>Dates & Walnuts</th> <th>Water</th> <th>Butter</th> <th>Sugar</th> <th>Flour</th> <th>Egg</th> <th>Extra</th> </tr> </thead> <tbody> <tr> <td>0</td> <td>Mayonnaise Cake</td> <td>2</td> <td>1.00</td> <td>0.5</td> <td>1.00</td> <td>2.00</td> <td>1</td> <td>1 mayonnaise</td> </tr> <tr> <td>1</td> <td>Cheese Cake</td> <td>2</td> <td>2.00</td> <td>1.5</td> <td>2.25</td> <td>3.00</td> <td>2</td> <td>2t baking soda</td> </tr> <tr> <td>2</td> <td>Chocolate Cake</td> <td>1</td> <td>2.00</td> <td>0.0</td> <td>2.50</td> <td>2.75</td> <td>4</td> <td>2t baking soda</td> </tr> </tbody> </table> <p>The above is an example of the recipe table with horizontal view. The first row displays the data item name of each column. The other rows display one recipe per row. The first column displays the recipe number. You can create scroll button groups or scroll bars to scroll the contents.</p>	No.	Name	Dates & Walnuts	Water	Butter	Sugar	Flour	Egg	Extra	0	Mayonnaise Cake	2	1.00	0.5	1.00	2.00	1	1 mayonnaise	1	Cheese Cake	2	2.00	1.5	2.25	3.00	2	2t baking soda	2	Chocolate Cake	1	2.00	0.0	2.50	2.75	4	2t baking soda
No.	Name	Dates & Walnuts	Water	Butter	Sugar	Flour	Egg	Extra																													
0	Mayonnaise Cake	2	1.00	0.5	1.00	2.00	1	1 mayonnaise																													
1	Cheese Cake	2	2.00	1.5	2.25	3.00	2	2t baking soda																													
2	Chocolate Cake	1	2.00	0.0	2.50	2.75	4	2t baking soda																													
Vertical View	<p>Displays the recipes in columns and recipe data items in rows.</p> <table border="1"> <thead> <tr> <th>No.</th> <th>0</th> <th>1</th> <th>2</th> </tr> </thead> <tbody> <tr> <td>Name</td> <td>Mayonnaise Cake</td> <td>Cheese Cake</td> <td>Chocolate Cake</td> </tr> <tr> <td>Dates & Walnuts</td> <td>2</td> <td>2</td> <td>1</td> </tr> <tr> <td>Water</td> <td>1.00</td> <td>2.00</td> <td>2.00</td> </tr> <tr> <td>Butter</td> <td>0.5</td> <td>1.5</td> <td>0.0</td> </tr> <tr> <td>Sugar</td> <td>1.00</td> <td>2.25</td> <td>2.50</td> </tr> <tr> <td>Flour</td> <td>2.00</td> <td>3.00</td> <td>2.75</td> </tr> <tr> <td>Egg</td> <td>1</td> <td>2</td> <td>4</td> </tr> <tr> <td>Extra</td> <td>1 mayonnaise</td> <td>2t baking soda</td> <td>2t baking soda</td> </tr> </tbody> </table> <p>The above is an example of the recipe table with vertical view. The first column displays the data item name of each row. The other columns display one recipe per column. The first row displays the recipe number. You can create scroll button groups or scroll bars to scroll the contents.</p>	No.	0	1	2	Name	Mayonnaise Cake	Cheese Cake	Chocolate Cake	Dates & Walnuts	2	2	1	Water	1.00	2.00	2.00	Butter	0.5	1.5	0.0	Sugar	1.00	2.25	2.50	Flour	2.00	3.00	2.75	Egg	1	2	4	Extra	1 mayonnaise	2t baking soda	2t baking soda
No.	0	1	2																																		
Name	Mayonnaise Cake	Cheese Cake	Chocolate Cake																																		
Dates & Walnuts	2	2	1																																		
Water	1.00	2.00	2.00																																		
Butter	0.5	1.5	0.0																																		
Sugar	1.00	2.25	2.50																																		
Flour	2.00	3.00	2.75																																		
Egg	1	2	4																																		
Extra	1 mayonnaise	2t baking soda	2t baking soda																																		
Current Recipe	<p>Displays the recipe data items of the current recipe in rows.</p> <table border="1"> <tbody> <tr> <td>Name</td> <td>Mayonnaise Cake</td> </tr> <tr> <td>Dates & Walnuts</td> <td>2</td> </tr> <tr> <td>Water</td> <td>1.00</td> </tr> <tr> <td>Butter</td> <td>0.5</td> </tr> <tr> <td>Sugar</td> <td>1.00</td> </tr> <tr> <td>Flour</td> <td>2.00</td> </tr> <tr> <td>Egg</td> <td>1</td> </tr> <tr> <td>Extra</td> <td>1 mayonnaise</td> </tr> </tbody> </table> <p>The above is an example of the current recipe. The first column displays the data item name of each row. The other column displays the current recipe. You can create scroll button groups or scroll bars to scroll the contents.</p>	Name	Mayonnaise Cake	Dates & Walnuts	2	Water	1.00	Butter	0.5	Sugar	1.00	Flour	2.00	Egg	1	Extra	1 mayonnaise																				
Name	Mayonnaise Cake																																				
Dates & Walnuts	2																																				
Water	1.00																																				
Butter	0.5																																				
Sugar	1.00																																				
Flour	2.00																																				
Egg	1																																				
Extra	1 mayonnaise																																				

10.7.2. Operation Options

The following operation option can be added to a recipe table. Select and set up the option in the recipe table property sheet.

Options	Description
Visibility Control	You can show or hide a recipe table by a specified bit or the current user level. Select and set up this option in the Visibility page.

10.7.3. Settings

You can complete all the settings of a recipe table in the Recipe Table property sheet. This sheet contains the following three pages.

- **General**
Described in [Section 10.7.4.](#)
- **Data Item**
Described in [Section 10.7.5.](#)
- **Visibility**
Described in [Section 4.4.6.](#)

10.7.4. General Settings

This section describes how to define the general settings for a recipe table. The following is an example of the General page.

Name	AAAAAAAAAAAAAAAAAAAA
Dates & Walnuts	9999
Water	-99.99
Butter	-999.9
Sugar	-99.99
Flour	-99.99
Egg	9999
Extra	AAAAAAAAAAAAAAAAAAAA

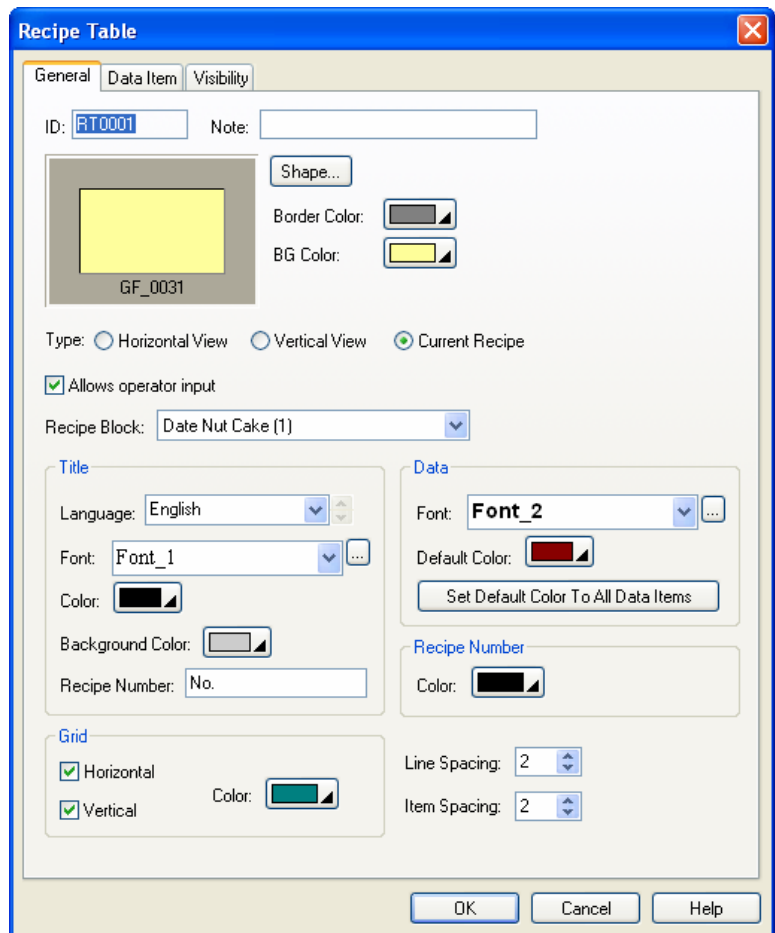

The following table describes each property in the General page.

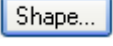
Property		Description								
ID		The object's identifier. It is generated when the object is created and is unchangeable. The identifier is unique within the screen where the object is located. The format of the IDs for the recipe tables is RTnnnn.								
Note		You can type a note for the object.								
Shape settings		For details about the following properties, Section 4.3.4 Setting up the Shape of an Object .  , Border Color, BG Color								
Type		Select one of the following types for the recipe table: <table border="1" data-bbox="533 546 1461 808"> <thead> <tr> <th>Type</th> <th>Description</th> </tr> </thead> <tbody> <tr> <td>Horizontal View</td> <td>Displays the recipes in rows and recipe data items in columns.</td> </tr> <tr> <td>Vertical View</td> <td>Displays the recipes in columns and recipe data items in rows.</td> </tr> <tr> <td>Current Recipe</td> <td>Displays the recipe data items of the current recipe in rows.</td> </tr> </tbody> </table>	Type	Description	Horizontal View	Displays the recipes in rows and recipe data items in columns.	Vertical View	Displays the recipes in columns and recipe data items in rows.	Current Recipe	Displays the recipe data items of the current recipe in rows.
Type	Description									
Horizontal View	Displays the recipes in rows and recipe data items in columns.									
Vertical View	Displays the recipes in columns and recipe data items in rows.									
Current Recipe	Displays the recipe data items of the current recipe in rows.									
Allows operator input		Check this option if you allow the operator to update the value of the recipe data item.								
Recipe Block		Select the recipe whose collected data is to be displayed by the object.								
Title	Language	Select a language so you can view and edit the settings of the title row for that language.								
	Font	Select a font for the title text.								
	Color	Select a color for the title text.								
	Background Color	Select a color for the background of the title row.								
	Recipe Number	Specifies the title for the recipe number column.								
Grid	Vertical	Check this option if you want the object to have vertical grids.								
	Horizontal	Check this option if you want the object to have horizontal grids.								
	Color	Select a color for the grids.								
Data	Font	Select a font for displaying data.								
	Default Color	Select a color as the default color for displaying data.								
	Set Default Color to All Data Items	Click this button to set the colors of all the data items to the Default Color.								
Recipe Number	Color	Select a color for the recipe number.								
Line Spacing		Specifies the extra space in pixels for two adjacent rows in the table.								
Item Spacing		Specifies the extra space for every column in the table.								

10.7.5. Data Item Settings

This section describes how to define the display format for the values of each data item. The following is an example of the Data Item page.

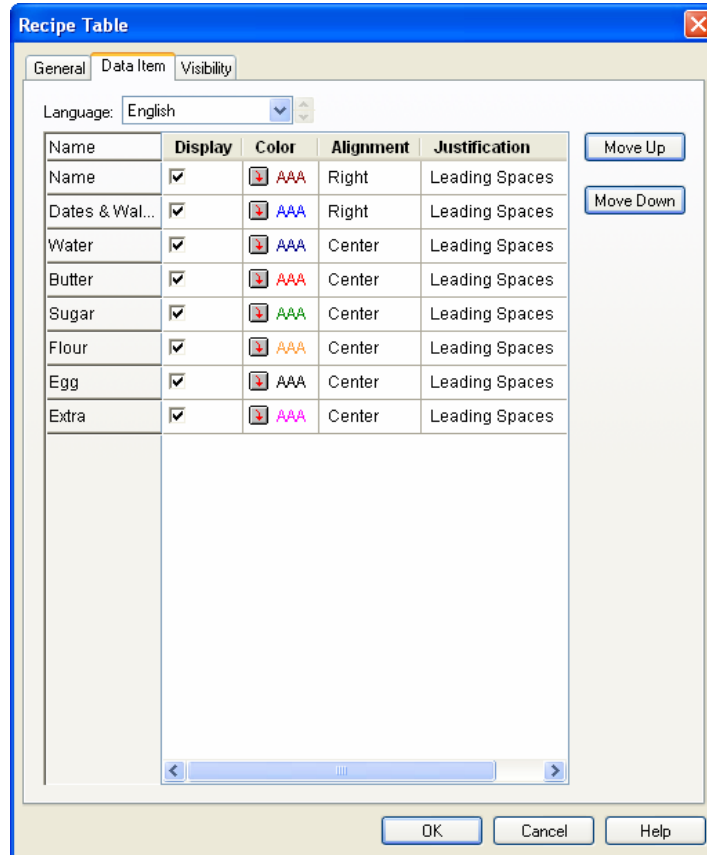

The following table describes each property in the Data Item page.

Property		Description							
Language		Select a language so you can view and edit the settings for that language.							
Row #n of the property table	Name	The name of data item #n. The data item names are defined in the Data Item page of the Data Logger dialog box.							
	Display	Check this option if you want the object to display data item #n.							
	Color	Select a color for displaying data item #n.							
	Alignment	The alignment for displaying data item #n. There are three types of alignments: Left, Center, and Right.							
	Justification	The justification for displaying data item #n. There are three types of justifications: <table border="1" style="width: 100%; margin-top: 5px;"> <thead> <tr> <th>Option</th> <th>Description</th> </tr> </thead> <tbody> <tr> <td>Zero Suppress</td> <td>The leading digits will not display when they are 0.</td> </tr> <tr> <td>Leading Zeros</td> <td>All digits will display.</td> </tr> <tr> <td>Leading Spaces</td> <td>The leading digits will display as blank characters when they are 0.</td> </tr> </tbody> </table>	Option	Description	Zero Suppress	The leading digits will not display when they are 0.	Leading Zeros	All digits will display.	Leading Spaces
Option	Description								
Zero Suppress	The leading digits will not display when they are 0.								
Leading Zeros	All digits will display.								
Leading Spaces	The leading digits will display as blank characters when they are 0.								
Move Up		Click the button to move the selected data item before the previous data item. The Move Up button will help you to reorder the display sequence of the data items. It will not be available when multiple rows are selected or no row is selected.							
Move Down		Click the button to move the selected data item after the next data item. The Move Down button will help you to reorder the display sequence of the data items. It will not be available when multiple rows are selected or no row is selected.							

CHAPTER 11

ALARMS AND ALARM DISPLAYS

11.1. Using Alarms	1
11.2. Setting Up Alarm Processing	2
11.3. Working with Alarm Blocks	4
11.3.1. Creating an Alarm Block	4
11.3.2. Importing and Exporting an Alarm Block	4
11.3.3. Deleting an Alarm Block	4
11.3.4. Specifying To-be-recorded Data	5
11.4. Discrete Alarm Blocks	7
11.4.1. Settings	7
11.5. Analog Alarm Blocks	11
11.5.1. Settings	11
11.6. Alarm Displays	15
11.6.1. Basic Operations	15
11.6.2. Operation Options.....	17
11.6.3. Settings	17
11.6.4. General Settings.....	18
11.6.5. Query Settings	21

In order to use alarm display for your application, you need to set up alarm processing first, and then define an alarm block. This chapter describes how to set up alarm processing and the alarm block. It also describes how to configure the alarm display to show alarm history, alarm count, active alarm and alarm marquee.

11.1. Using Alarms

To use an alarm in your application, please follow the procedure as below:

1. Setting up alarm processing
Described in [Section 11.2](#)
2. Creating and configuring discrete alarm blocks or analog alarm blocks
Described in [Section 11.4](#) and [Section 11.5](#)
3. Creating and configuring alarm displays
Described in [Section 11.6](#)

You can use the command flag setting in the command block or function button to request the panel to clear the alarm history or clear the alarm count.

To know how to set up the command flag in the command block, please see [Section 3.5.1 Command Block and Status Words](#). To know how to define a function button, please see [Section 5.4.1 Basic Operations](#) on function buttons.

11.2. Setting Up Alarm Processing

You can set up the alarm processing with the Alarm Properties dialog box. In this dialog, you can determine the required memory for the alarm logging buffer, choose the default color and font for the alarm message, specify how to save the alarm history records to a text file and configure the global alarm marquee if you want to display it on the screen. To open the dialog box for alarm processing, please double click the node named Alarms in the Project Manager tool window. The following is an example of the Alarm Properties dialog box.

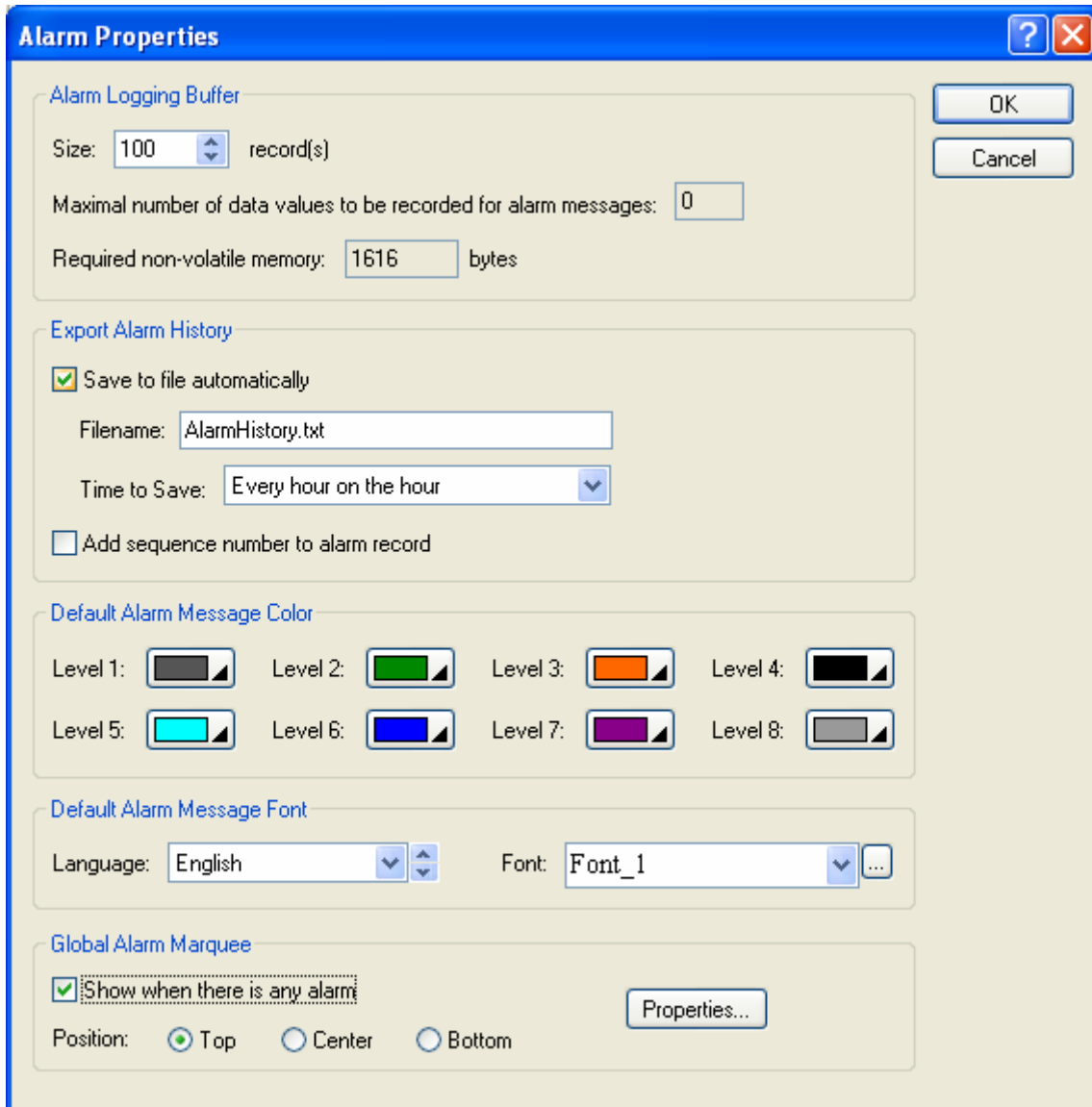

The table below describes each property in the Alarm Properties dialog.

Property		Description
Alarm Logging Buffer	Size	The maximum number of records that the alarm logging buffer can hold. For example: 100 means that when the 101 st alarm occurs, the 1 st record will be overwritten.
	Required non-volatile memory	The size of the alarm logging buffer. The unit is byte. The formula to calculate the size is: Alarm Logging Buffer Size = Number of Records * 16 + Maximal Number of Data Values for Each Record * 4 + 16.

Continued

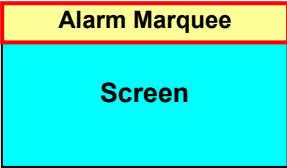
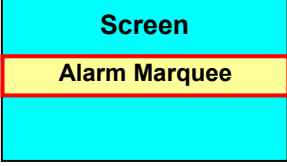
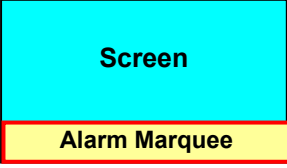
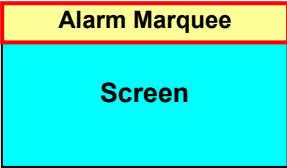
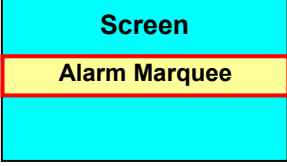
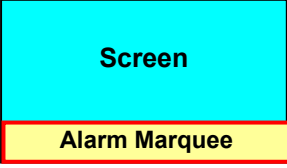
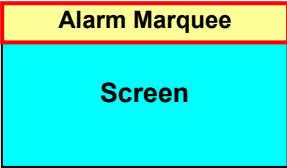
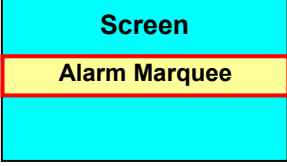
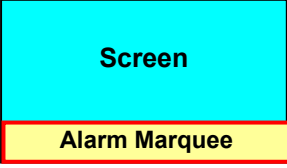
Property		Description												
Export Alarm History	Save to file automatically	Check this option so the most current alarm history record will be written to a specified file periodically. Each time the operation is performed, the panel writes only the record that has not already been saved to the file.												
	File Name	The filename or the prefix of the filename of the file to save the alarm record as. The alarm records are saved in text format and the file extension name must be ".txt". You can use any text editor or Microsoft Excel to view the alarm records directly. This item is available when the option Save alarm history to file is checked.												
	Time to Save	Specifies the period to save the alarm history records. This item is available when the option Save alarm history to file is checked. There are nine periods available: Every hour on the hour ; Every 8 hours (00:00, 08:00, 16:00) ; Every 12 hours (00:00, 12:00) Every day at 00:00; Every day at 08:00; Every day at 12:00; Every Sunday at 00:00; Every Monday at 00:00; Every first day of the month at 00:00.												
	Add sequence number to alarm record	Check this option so the exported alarm history can have the sequence numbers for the alarm records.												
Default Alarm Message Color	Level 1, Level 2... Level 8	Select a default color for alarm levels 1, 2...8. The alarm display for each alarm level will show an alarm message with the selected color.												
Default Alarm Message Font	Language	Select a default language so you can view and edit the language dependent settings in the Text group for that language. The language dependent properties in the Text group include Font and Alarm Status Abbreviation.												
	Font	Select a default font for the text of the alarm message.												
Global Alarm Marquee	Show when there is any alarm	Check this option if you want to show the global alarm marquee on the current screen when there is any alarm.												
	Position	Select one of the following 3 positions for the global alarm marquee to be displayed.												
		<table border="1"> <thead> <tr> <th>Position</th> <th>Description</th> <th></th> </tr> </thead> <tbody> <tr> <td>Top</td> <td>The global alarm marquee shows up at the top of the screen.</td> <td>  </td> </tr> <tr> <td>Center</td> <td>The global alarm marquee shows up at the center of the screen.</td> <td>  </td> </tr> <tr> <td>Bottom</td> <td>The global alarm marquee shows up at the bottom of the screen.</td> <td>  </td> </tr> </tbody> </table>	Position	Description		Top	The global alarm marquee shows up at the top of the screen.		Center	The global alarm marquee shows up at the center of the screen.		Bottom	The global alarm marquee shows up at the bottom of the screen.	
		Position	Description											
Top	The global alarm marquee shows up at the top of the screen.													
Center	The global alarm marquee shows up at the center of the screen.													
Bottom	The global alarm marquee shows up at the bottom of the screen.													
Properties	Click the button to bring up the Alarm Display dialog box to set up the properties of the global alarm marquee. Please see Section 11.6.4 for details.													

11.3. Working with Alarm Blocks

11.3.1. Creating an Alarm Block

To create a discrete alarm block, you may do one of the following:

- 1) In the Project Manager tool window, right-click the Alarms node of the concerned panel application and select Add Discrete Alarm Block.
- 2) In the menu bar, click Panel to bring up the Panel sub-menu. Click Discrete Alarm Block in the Panel sub-menu to bring up the pop-up menu. Select Add in the pop-up menu.

To create an analog alarm block, you may do one of the following:

- 1) In the Project Manager tool window, right-click the Alarms node of the concerned panel application and select Add Analog Alarm Block.
- 2) In the menu bar, click Panel to bring up the Panel sub-menu. Click Analog Alarm Block in the Panel sub-menu to bring up the pop-up menu. Select Add in the pop-up menu.

11.3.2. Importing and Exporting an Alarm Block

To import an alarm block, right-click the Alarms node and then select Import Alarm Block... in the Project Manager window. Select *.alm file in the Open file dialog and then click Open.

To export a discrete alarm block, right-click the node of the desired discrete alarm block and then select Export Alarm Block.... in the Project Manager window.

To export an analog alarm block, right-click the node of the desired analog alarm block and then select Export Alarm Block.... in the Project Manager window.

11.3.3. Deleting an Alarm Block

To delete a discrete alarm block, you may do one of the following:

- 1) In the Project Manager window, right-click the node of the desired discrete alarm block and then select Delete.
- 2) In the menu bar, click Panel to bring up the Panel sub-menu. Click Discrete Alarm Block in the Panel sub-menu to bring up the Discrete Alarm Block pop-up menu. Select Delete in the pop-up menu to bring up the discrete alarm block list of the current panel application. Select the desired discrete alarm block in the list.

To delete an analog alarm block, you may do one of the following:

- 1) In the Project Manager window, right-click the node of the desired analog alarm block and then select Delete.
- 2) In the menu bar, click Panel to bring up the Panel sub-menu. Click Analog Alarm Block in the Panel sub-menu to bring up the Analog Alarm Block pop-up menu. Select Delete in the pop-up menu to bring up the analog alarm block list of the current panel application. Select the desired analog alarm block in the list.

11.3.4. Specifying To-be-recorded Data

You can record maximum 8 data values and display them in the alarm message. The data value will be appended to the alarm message with the following format:

(Name: Value of the address with the specified format)

For example, the recorded value #2 will display the **32-bit floating point number** stored in **W10** with the format of **4 total digits** and **1 fractional digit**.

If the value of W10 is 123.456 when the alarm occurs, the following text will be appended to its alarm message:
(Temperature: 123.4)

To specify values, use the Specify To-be-recorded Data dialog. The following is an example of the dialog:

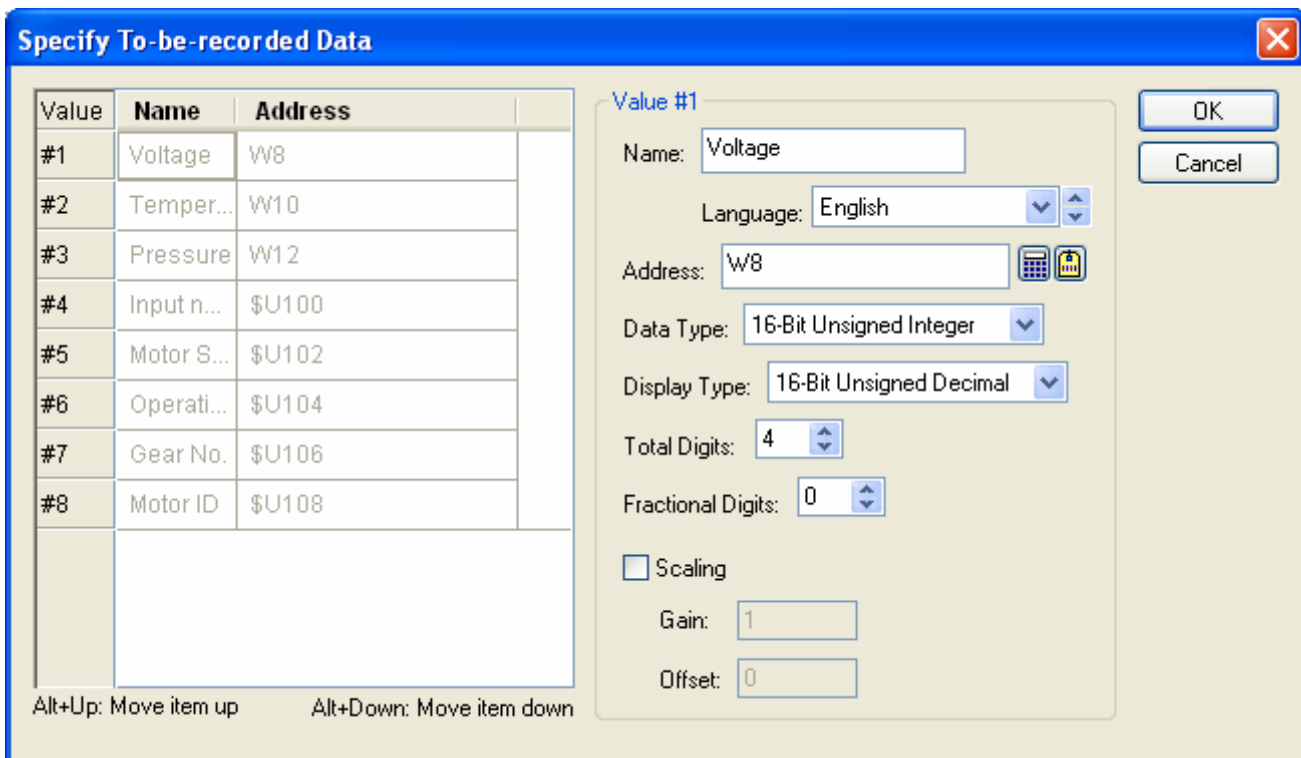

The Specify To-be-recorded Data dialog contains two parts. The left side lists the address and name of each value. The right side shows the properties of the selected value. To select a value, click the row of the value in the list. The following table describes each property of the value.

Property	Description
Name	Specifies the name of the data item for the language specified in the Language field.
Language	Select a language so you can view and edit the name of the value for that language.
Address	The read address of the value. The address can be any valid word address.
Data Type	The data type of the value. The supported data types include: 16-Bit Unsigned Integer, 32-Bit Unsigned Integer, 16-Bit Signed Integer, 32-Bit Signed Integer, 16-Bit BCD, 32-Bit BCD, 32-Bit Floating Point.

Continued

Property	Description																									
Display Type	<p>The display type for the value of the data item. The following table shows the available display types for each data type.</p> <table border="1"> <thead> <tr> <th>Data Type</th> <th>Available Display Types</th> </tr> </thead> <tbody> <tr> <td>16-Bit Unsigned Integer</td> <td>16-Bit Unsigned Decimal, 16-Bit Hexadecimal, 16-Bit Octal</td> </tr> <tr> <td>32-Bit Unsigned Integer</td> <td>32-Bit Unsigned Decimal, 32-Bit Hexadecimal, 32-Bit Octal</td> </tr> <tr> <td>16-Bit Signed Integer</td> <td>16-Bit Signed Decimal</td> </tr> <tr> <td>32-Bit Signed Integer</td> <td>32-Bit Signed Decimal</td> </tr> <tr> <td>16-Bit BCD</td> <td>16-Bit Unsigned Decimal</td> </tr> <tr> <td>32-Bit BCD</td> <td>32-Bit Unsigned Decimal</td> </tr> <tr> <td>32-Bit Floating Point</td> <td>32-Bit Floating Point</td> </tr> </tbody> </table>	Data Type	Available Display Types	16-Bit Unsigned Integer	16-Bit Unsigned Decimal, 16-Bit Hexadecimal, 16-Bit Octal	32-Bit Unsigned Integer	32-Bit Unsigned Decimal, 32-Bit Hexadecimal, 32-Bit Octal	16-Bit Signed Integer	16-Bit Signed Decimal	32-Bit Signed Integer	32-Bit Signed Decimal	16-Bit BCD	16-Bit Unsigned Decimal	32-Bit BCD	32-Bit Unsigned Decimal	32-Bit Floating Point	32-Bit Floating Point									
Data Type	Available Display Types																									
16-Bit Unsigned Integer	16-Bit Unsigned Decimal, 16-Bit Hexadecimal, 16-Bit Octal																									
32-Bit Unsigned Integer	32-Bit Unsigned Decimal, 32-Bit Hexadecimal, 32-Bit Octal																									
16-Bit Signed Integer	16-Bit Signed Decimal																									
32-Bit Signed Integer	32-Bit Signed Decimal																									
16-Bit BCD	16-Bit Unsigned Decimal																									
32-Bit BCD	32-Bit Unsigned Decimal																									
32-Bit Floating Point	32-Bit Floating Point																									
Total Digits	Specifies the number of digits to be displayed for the value of the item.																									
Fractional Digits	<p>Specifies how to display the fractional part for the value of the item. When the Display Type is 32-bit Floating Point, this property specifies the number of fractional digits to be displayed. When the Display Type is not 32-bit Floating Point, this property specifies not only the number of fractional digits to be displayed, but also the number of least significant digits to be displayed as the fractional part. With this feature, an integer can be shown as a fixed point number.</p> <p>Example:</p> <table border="1"> <thead> <tr> <th>Display Type</th> <th>Total Digits</th> <th>Fractional Digits</th> <th>Sampled Value</th> <th>Displayed Value</th> </tr> </thead> <tbody> <tr> <td>32-bit Floating Point</td> <td>4</td> <td>2</td> <td>12.34</td> <td>12.34</td> </tr> <tr> <td>32-bit Floating Point</td> <td>4</td> <td>2</td> <td>123.4</td> <td>23.40</td> </tr> <tr> <td>16-bit Signed Decimal</td> <td>5</td> <td>2</td> <td>12345</td> <td>123.45</td> </tr> <tr> <td>16-bit Signed Decimal</td> <td>5</td> <td>2</td> <td>-5</td> <td>-0.05</td> </tr> </tbody> </table>	Display Type	Total Digits	Fractional Digits	Sampled Value	Displayed Value	32-bit Floating Point	4	2	12.34	12.34	32-bit Floating Point	4	2	123.4	23.40	16-bit Signed Decimal	5	2	12345	123.45	16-bit Signed Decimal	5	2	-5	-0.05
Display Type	Total Digits	Fractional Digits	Sampled Value	Displayed Value																						
32-bit Floating Point	4	2	12.34	12.34																						
32-bit Floating Point	4	2	123.4	23.40																						
16-bit Signed Decimal	5	2	12345	123.45																						
16-bit Signed Decimal	5	2	-5	-0.05																						
Scaling	<p>Check this option if you want the value of the data item to be displayed in a scaled manner. The following is the scaling formula:</p> $\text{DisplayedValue} = \text{SampledValue} * \text{Gain} + \text{Offset}$ <p>Note: The <i>Gain</i> and <i>Offset</i> are 32-bit floating point numbers. They have, at most, 6 significant digits. Rounding and truncation errors may happen.</p>																									
Gain	Available when the Scaling option is checked. Specifies the <i>Gain</i> used in the scaling formula.																									
Offset	Available when the Scaling option is checked. Specifies the <i>Offset</i> used in the scaling formula.																									

11.4. Discrete Alarm Blocks

You can set up a discrete alarm block with the Discrete Alarm Block dialog box. There are two ways to open the dialog box:

- 1) In the Project Manager window, move the mouse to the node of the desired discrete alarm block and double click the node or right-click the node and then select Properties.
- 2) In the menu bar, click Panel to bring up the Panel sub-menu. Click Discrete Alarm Block in the Panel sub-menu to bring up the Discrete Alarm Block pop-up menu. Select Properties in the pop-up menu to bring up the discrete alarm block list of the current panel application. Select the desired discrete alarm block in the list.

11.4.1. Settings

Use the dialog box to define all the settings for a discrete alarm block. The following is an example of the discrete alarm block dialog.

Discrete Alarm Block

Block Name: Block ID:

Type: Read Address:

Block Size: Read Interval: seconds

Record specified data values
Number of data values:

No.	Address	Use	Message
1	\$U400.0	<input checked="" type="checkbox"/>	Invalid input number
2	\$U400.1	<input checked="" type="checkbox"/>	No1. motor error
3	\$U400.2	<input checked="" type="checkbox"/>	Unstable voltage
4	\$U400.3	<input checked="" type="checkbox"/>	Temperature too high
5	\$U400.4	<input checked="" type="checkbox"/>	Improper operation
6	\$U400.5	<input checked="" type="checkbox"/>	Sense invalid operation
7	\$U400.6	<input checked="" type="checkbox"/>	Program running error
8	\$U400.7	<input checked="" type="checkbox"/>	Pressure too low
9	\$U400.8	<input checked="" type="checkbox"/>	Gear broken
10	\$U400.9	<input checked="" type="checkbox"/>	Emergency Stop

Discrete Alarm

Address:

Alarm State: Level: ID:

Message

Language:

Text:

Show Recorded Value: #1 #2 #3 #4
 #5 #6 #7 #8

Record alarm Sound Buzzer

Display message

Display screen

Require Acknowledgement

Record ACK

Notification Bit:



Tip Screen

Play Sound Sound:

Number of Plays: Break Between Plays: Sec.

Alt+Up: Move item up Alt+Down: Move item down

The table below describes some properties in the Discrete Alarm Block dialog.

Property		Description										
Block Name		The discrete alarm block's name. The maximum length of the name is 20 characters.										
Block ID		The discrete alarm block's ID number. Select a number between 0 and 15. The number is unique among all discrete alarm blocks of the panel application.										
Type		<p>Specifies the memory type used to allocate the discrete alarm block. There are four types:</p> <table border="1"> <thead> <tr> <th>Type</th> <th>Description</th> </tr> </thead> <tbody> <tr> <td>Bits</td> <td>Select Bits to create a discrete alarm block starting from the bit device M with N continuous bits</td> </tr> <tr> <td>Bits of Word Device</td> <td>Select Bits of Word Device to create a discrete alarm block starting from the bit 0 of the word device M with N continuous bits of the word device.</td> </tr> <tr> <td>Word Value</td> <td>Select Word Value to create a discrete alarm block at word device M. An alarm will occur if the value of M is between 0 and N.</td> </tr> <tr> <td>Random Bits</td> <td>Select Random Bits to create a discrete alarm block with N specified random bits.</td> </tr> </tbody> </table> <p>Legend: M: An address specified in Read Address field. N: A size specified in Block Size/Maximum field.</p>	Type	Description	Bits	Select Bits to create a discrete alarm block starting from the bit device M with N continuous bits	Bits of Word Device	Select Bits of Word Device to create a discrete alarm block starting from the bit 0 of the word device M with N continuous bits of the word device.	Word Value	Select Word Value to create a discrete alarm block at word device M . An alarm will occur if the value of M is between 0 and N .	Random Bits	Select Random Bits to create a discrete alarm block with N specified random bits.
Type	Description											
Bits	Select Bits to create a discrete alarm block starting from the bit device M with N continuous bits											
Bits of Word Device	Select Bits of Word Device to create a discrete alarm block starting from the bit 0 of the word device M with N continuous bits of the word device.											
Word Value	Select Word Value to create a discrete alarm block at word device M . An alarm will occur if the value of M is between 0 and N .											
Random Bits	Select Random Bits to create a discrete alarm block with N specified random bits.											
Read Address		<p>Specifies the starting address of an alarm block to monitor the status of alarms.</p> <p>Click  to enter an address for this field. Click  to select a tag for this field.</p>										
Block Size / Maximum		<p>Specifies the block size of an alarm block. The unit is bit. The maximum block size or maximum value you can specify depends on the type selected. The following table lists the limitation of each type:</p> <table border="1"> <thead> <tr> <th>Type</th> <th>Maximum block size/value</th> </tr> </thead> <tbody> <tr> <td>Bits</td> <td>256</td> </tr> <tr> <td>Bits of Word Device</td> <td>256</td> </tr> <tr> <td>Word Value</td> <td>0-511</td> </tr> <tr> <td>Random Bits</td> <td>64</td> </tr> </tbody> </table>	Type	Maximum block size/value	Bits	256	Bits of Word Device	256	Word Value	0-511	Random Bits	64
Type	Maximum block size/value											
Bits	256											
Bits of Word Device	256											
Word Value	0-511											
Random Bits	64											
Read Interval		Specifies a period between 1 to 3600 seconds that the panel reads the Alarm Block and checks the state of every bit in the block. The shorter the Read Interval is, the faster the alarm display object will be refreshed, but the refresh rate of other objects will be slower.										
Record specified data values	<Check Box>	Check this option if you want to record the specified data values and display them in the alarm message.										
	Number of data values	The number of data values you want to record. The maximum is 8.										
	Specify...	Click the button to specify the recorded data values. For details, please see Section 11.3.4 Specifying To-be-recorded Data .										

To specify all discrete alarms, you need to set the discrete alarm list and the discrete alarm properties field. The discrete alarm list is located at the bottom-left of the dialog, and shows all the discrete alarms in the alarm block. The discrete alarm properties field is located at the right of the alarm list, and shows all the properties of the selected discrete alarm.







The following table describes each column in the discrete alarm list.

Column	Description
No.	The number of the discrete alarm in the alarm block.
Address/Bit No./Value	If the type is Bits or Random Bits, the column shows the address of the discrete alarm. If the type is Bits of Word Device, the column shows the bit no of the discrete alarm. If the type is Word Value, the column shows the value of the discrete alarm.
Use	Check this option if you want to use discrete alarm #n.
Message	Displays a specified alarm message in the selected language.

You need to make a selection before editing the discrete alarm. To select a discrete alarm, click the row of that alarm in the list. To select multiple rows, click the row on its header column and use Ctrl + Click to add a row to the selection.

If multiple rows are selected, any modification on the common properties such as Level, Record alarm, Sound Buzzer, Display message, Display screen, Required Acknowledgement, Record ACK, Notification, Tip Screen...will apply to all selected discrete alarms

The following table describes each property of the selected discrete alarm.

Property	Description															
Address/Bit No./Value	Indicates the status of its corresponding alarm. The meaning of the field depends on the selected type. <table border="1" data-bbox="470 1010 1500 1332"> <thead> <tr> <th>Field Name</th> <th>Type</th> <th>Description</th> </tr> </thead> <tbody> <tr> <td>Address</td> <td>Bits</td> <td>Shows the address of the selected discrete alarm</td> </tr> <tr> <td>Bit No.</td> <td>Bits of Word Device</td> <td>Shows the bit no. of the selected discrete alarm</td> </tr> <tr> <td>Value</td> <td>Word Value</td> <td>Shows the value of the selected discrete alarm</td> </tr> <tr> <td>Address</td> <td>Random Bits</td> <td>Specifies the bit variable of the selected discrete alarm. Click  to enter an address. Click  to select a tag.</td> </tr> </tbody> </table>	Field Name	Type	Description	Address	Bits	Shows the address of the selected discrete alarm	Bit No.	Bits of Word Device	Shows the bit no. of the selected discrete alarm	Value	Word Value	Shows the value of the selected discrete alarm	Address	Random Bits	Specifies the bit variable of the selected discrete alarm. Click  to enter an address. Click  to select a tag.
Field Name	Type	Description														
Address	Bits	Shows the address of the selected discrete alarm														
Bit No.	Bits of Word Device	Shows the bit no. of the selected discrete alarm														
Value	Word Value	Shows the value of the selected discrete alarm														
Address	Random Bits	Specifies the bit variable of the selected discrete alarm. Click  to enter an address. Click  to select a tag.														
Alarm State	Specify the alarm state to indicate the corresponding alarm is active. If 1(On) is selected, a bit with high (on) state indicates that the corresponding alarm is active. And a bit with low (off) state indicates that the corresponding alarm is clear.															
Level	Select a level for the alarm between 1 and 8.															
ID	Specifies the alarm ID. The maximum length of the ID is 6 characters.															
Message	Language	Select an existing language that you are setting the message to.														
	Import All...	Click the button to import the texts of *.csv files, and save the texts as the alarm messages for the current language.														
	Export All...	Click the button to export all the messages for the selected language to a *.csv file.														
	Text	Specifies the text for the current language. The text will be shown when the alarm is active.														
	Show Recorded Value	Check the specified value you want to record and display in the alarm message. Note that only the selected value will be recorded.														
Record alarm	Check this option if you want to record the alarm to the alarm display object.															
Sound Buzzer	Check this option if you want the panel to play the sound buzzer when the alarm is activated or cleared.															

Continued

Property		Description
Display message		Check this option if you want the panel to automatically display a message when the alarm is activated or cleared. This field can be checked only when Display screen is unchecked.
Display screen	<Check Box>	Check this option if you want the panel to automatically display a window screen when the alarm is activated or cleared. This field can be checked only when Display message is unchecked.
		Select a window screen to display when the alarm is activated or cleared. The field is available when Display Screen is selected. Note that only Window Screens will be available to choose from.
Required Acknowledgement	<Check Box>	Check this option if you want the operator to acknowledge an alarm. When an alarm becomes active, the panel displays an alarm message or a screen with ACK button when the Required Acknowledgement option is selected. The operator should press the ACK button to acknowledge the alarm, and have the panel refresh the current screen. This field is available when either Display message or Display screen is selected.
	Record ACK	Check this option if you want to record ACK to the alarm display object
	Notification	Check this option if you want to notify the specified bit when the ACK button is clicked.
	Bit	Specifies the bit that receives the notification.
Tip Screen	<Check Box>	Check this option if you want to display a screen when you select the corresponding alarm on the alarm display object.
		Select a window screen as the tip screen.
Play Sound	<Check Box>	Check this option if you want the panel to play sound when the alarm is activated or cleared.
	Sound	Select a sound from sound table of the current panel application.
	Number of Plays	Specifies how many times you want to play the sound.
	Break Between Plays	Specifies an interval between two plays. You can select 0s, 0.2s, 0.4s, 0.6s, 0.8s, 1s, 2s, 3s, 4s, 5s.

11.5. Analog Alarm Blocks

You can set up an analog alarm block with the Analog Alarm Block dialog box. There are two ways to open the dialog box:

- 1) In the Project Manager window, move the mouse to the node of the desired analog alarm block and double click the node or right-click the node and then select Properties.
- 2) In the menu bar, click Panel to bring up the Panel sub-menu. Click Analog Alarm Block in the Panel sub-menu to bring up the Analog Alarm Block pop-up menu. Select Properties in the pop-up menu to bring up the analog alarm block list of the current panel application. Select the desired analog alarm block from the list.

11.5.1. Settings

Use the dialog box to define all the settings for an analog alarm block. The following is an example of the analog alarm block dialog box.

Analog Alarm Block

Block Name: Analog Alarm Block Block ID: 64

Type: Continuous Words Read Address: \$U500 Number of data values: 8

Block Size: 12 words Read Interval: 1 seconds

No.	Address	Use	Message
1	\$U500	<input checked="" type="checkbox"/> Low Low	WARN00: NON-FACTORY DE
2	\$U500	<input checked="" type="checkbox"/> Low	
3	\$U500	<input type="checkbox"/> High	
4	\$U500	<input type="checkbox"/> High High	
5	\$U501	<input checked="" type="checkbox"/> Low Low	
6	\$U501	<input checked="" type="checkbox"/> Low	
7	\$U501	<input type="checkbox"/> High	
8	\$U501	<input type="checkbox"/> High High	
9	\$U502	<input checked="" type="checkbox"/> Low Low	
10	\$U502	<input checked="" type="checkbox"/> Low	
11	\$U502	<input type="checkbox"/> High	
12	\$U502	<input type="checkbox"/> High High	
13	\$U503	<input checked="" type="checkbox"/> Low Low	
14	\$U503	<input checked="" type="checkbox"/> Low	
15	\$U503	<input type="checkbox"/> High	
16	\$U503	<input type="checkbox"/> High High	
17	\$U504	<input checked="" type="checkbox"/> Low Low	
18			

Alt+Up: Move item up Alt+Down: Move item down

Analog Alarm

Alarm Type: Low Low Data Type: 16-Bit Unsigned Integ

Address: \$U500

Limit: 0 Hysteresis: 0 %

Level: 1 ID: A1

Message

Language: English Import All... Export All...

Text: WARN00: NON-FACTORY DEFAULT

Show Recorded Value: #1 #2 #3 #4
 #5 #6 #7 #8

Record alarm Sound Buzzer

Display alarm message

Display screen 40 Alarm

Require Acknowledgement



Record ACK Notification

Tip Screen

Play Sound Sound: Alarm (0)

Number of Plays: 1 Break Between Plays: 0 Sec.

The table below describes each property in the Analog Alarm Block dialog box.

Property		Description						
Block Name		The analog alarm block's name. The maximum length of the name is 20 characters.						
Block ID		The analog alarm block's ID number. Select a number between 64 and 79. The number is unique among all analog alarm blocks of the panel application.						
Type		Specifies the type of the analog alarm block. There are two types: <table border="1" data-bbox="475 421 1477 609"> <thead> <tr> <th>Type</th> <th>Description</th> </tr> </thead> <tbody> <tr> <td>Continuous Words</td> <td>Select Continuous Words to create an analog alarm block starting from the word device M with N continuous words</td> </tr> <tr> <td>Random Words</td> <td>Select Random Words to create an analog alarm block with N specified random words.</td> </tr> </tbody> </table> <p>Legend: M: An address specified in Read Address field. N: A size specified in Block Size.</p>	Type	Description	Continuous Words	Select Continuous Words to create an analog alarm block starting from the word device M with N continuous words	Random Words	Select Random Words to create an analog alarm block with N specified random words.
Type	Description							
Continuous Words	Select Continuous Words to create an analog alarm block starting from the word device M with N continuous words							
Random Words	Select Random Words to create an analog alarm block with N specified random words.							
Read Address		Specifies the starting address of an alarm block to monitor the status of alarms. Click  to enter an address for this field. Click  to select a tag for this field.						
Block Size		Specifies the block size of an alarm block. The unit is word. The maximum block size you can specify depends on the type you select. <table border="1" data-bbox="475 848 1482 976"> <thead> <tr> <th>Type</th> <th>Maximum block size</th> </tr> </thead> <tbody> <tr> <td>Continuous Words</td> <td>16</td> </tr> <tr> <td>Random Words</td> <td>64</td> </tr> </tbody> </table>	Type	Maximum block size	Continuous Words	16	Random Words	64
Type	Maximum block size							
Continuous Words	16							
Random Words	64							
Read Interval		Specifies a period between 1 to 3600 seconds that the panel reads the Alarm Block and checks the state of every bit in the block. The shorter the Read Interval is, the faster the alarm display object will be refreshed, but the refresh rate of other objects will be slower.						
Record specified data values	<Check Box>	Check this option if you want to record the specified data values and display them in the alarm message.						
	Number of data values	The number of data values you want to record. The maximum is 8.						
	Specify...	Click the button to specify the recorded data values. For details, please see Section 11.3.4 Specifying To-be-recorded Data .						

To specify all analog alarms, you need to set the analog alarm list and the analog alarm properties field. The analog alarm list is located at the bottom-left of the dialog, and shows all the analog alarms in the alarm block. The analog alarm properties field is located to the right of the list, and shows all the properties of the selected analog alarm.







The following table describes each column of the analog alarm list.

Column	Description
No.	The number of the analog alarm in the alarm block.
Address	Shows the address of the analog alarm.
Use	Check this option if you want to use analog alarm #n.
Message	Displays a specified alarm message in the selected language.

You need to make a selection before editing the analog alarm. To select an analog alarm, click the row of that alarm in the list. To select multiple rows, click the row on its header column and use Ctrl + Click to add a row to the selection.

If multiple rows are selected, any modification to the common properties such as Level, Record alarm, Sound Buzzer, Display message, Display screen, Required Acknowledgement, Record ACK, Notification, Tip Screen...will apply to all selected analog alarms

The following table describes each column in the analog alarm list.

Property		Description										
Alarm Type		<p>There are four types of analog alarms:</p> <table border="1"> <thead> <tr> <th>Type</th> <th>Description</th> </tr> </thead> <tbody> <tr> <td>Low Low</td> <td>An alarm will occur if the value of the destination variable is lower than or equal to the Low Low Limit.</td> </tr> <tr> <td>Low</td> <td>An alarm will occur if the value of the destination variable is equal to the Low Limit or between the Low Limit and the Low Low Limit.</td> </tr> <tr> <td>High</td> <td>An alarm will occur if the value of the destination variable is equal to the High Limit or between the High Limit and the High High Limit.</td> </tr> <tr> <td>High High</td> <td>An alarm will occur if the value of the destination variable is higher than or equal to the High High Limit.</td> </tr> </tbody> </table>	Type	Description	Low Low	An alarm will occur if the value of the destination variable is lower than or equal to the Low Low Limit.	Low	An alarm will occur if the value of the destination variable is equal to the Low Limit or between the Low Limit and the Low Low Limit.	High	An alarm will occur if the value of the destination variable is equal to the High Limit or between the High Limit and the High High Limit.	High High	An alarm will occur if the value of the destination variable is higher than or equal to the High High Limit.
Type	Description											
Low Low	An alarm will occur if the value of the destination variable is lower than or equal to the Low Low Limit.											
Low	An alarm will occur if the value of the destination variable is equal to the Low Limit or between the Low Limit and the Low Low Limit.											
High	An alarm will occur if the value of the destination variable is equal to the High Limit or between the High Limit and the High High Limit.											
High High	An alarm will occur if the value of the destination variable is higher than or equal to the High High Limit.											
Data Type		The data type of the destination variable. The supported data types include: 16-Bit Unsigned Integer, 32-Bit Unsigned Integer, 16-Bit Signed Integer, 32-Bit Signed Integer, 16-Bit BCD, 32-Bit BCD, 32-Bit Floating Point.										
Address		<p>Indicates the status of its corresponding alarm.</p> <table border="1"> <thead> <tr> <th>Type</th> <th>Description</th> </tr> </thead> <tbody> <tr> <td>Continuous Words</td> <td>Shows the address of the selected analog alarm.</td> </tr> <tr> <td>Random Words</td> <td>Specifies the word variable of the selected analog alarm. Click  to enter an address. Click  to select a tag.</td> </tr> </tbody> </table>	Type	Description	Continuous Words	Shows the address of the selected analog alarm.	Random Words	Specifies the word variable of the selected analog alarm. Click  to enter an address. Click  to select a tag.				
Type	Description											
Continuous Words	Shows the address of the selected analog alarm.											
Random Words	Specifies the word variable of the selected analog alarm. Click  to enter an address. Click  to select a tag.											
Limit		Set a limit for the alarm. The value range of the limit depends on the specified data type.										
Hysteresis		Set a range for the limit values for an alarm to turn OFF after it has been turned ON. If the alarm type is Low Low or Low, the range is between the Limit and Limit + Limit * Hysteresis/100. If the alarm type is High High or High, the range is between the Limit and Limit - Limit * Hysteresis/100.										
Level		Select a level for the alarm between 1 and 8.										
ID		Specifies the alarm ID. The maximum length of the ID is 6 characters.										
Message	Language	Select an existing language that you are setting the message for.										
	Import All...	Click the button to import the texts of *.csv files and saves the texts as the alarm messages for the current language.										
	Export All...	Click the button to export all the messages for the selected language to a *.csv file.										
	Text	Specifies the text for the current language. The text will be shown when the alarm is active.										
	Show Recorded Value	Check the specified value you want to record and display in the alarm message. Note that only the selected value will be recorded.										
Record alarm		Check this option if you want to record the alarm in the alarm display object.										
Sound Buzzer		Check this option if you want the panel to play a sound buzzer when the alarm is activated or cleared.										
Display alarm message		Check this option if you want the panel to display a message automatically when the alarm is activated or cleared. This field can be checked only when Display screen is unchecked.										

Continued

Property		Description
Display screen	<Check Box>	Check this option if you want the panel to display a window screen automatically when the alarm is activated or cleared. This field can be checked only when Display message is unchecked.
		Select a window screen to display when the alarm is activated or cleared. The field is available when Display Screen is selected. Note that only Window Screens will be available to choose from.
Required Acknowledgement	<Check Box>	Check this option if you want the operator to acknowledge an alarm. When an alarm becomes active, the panel displays an alarm message or a screen with ACK button when Required Acknowledgement is selected. The operator should press the ACK button to acknowledge the alarm and to have the panel refresh the current screen. This field is available when either Display message or Display screen is selected.
	Record ACK	Check this option if you want to record ACK in the alarm display object
	Notification	Check this option if you want to notify the specified bit when the ACK button is clicked.
	Bit	Specifies the bit that receives the notification.
Tip Screen	<Check Box>	Check this option if you want to display a screen when you select the corresponding alarm on the alarm display object.
		Select a window screen as the tip screen
Play Sound	<Check Box>	Check this option if you want the panel to play sound when the alarm is activated or cleared.
	Sound	Select a sound from sound table of the current panel application.
	Number of Plays	Specifies how many times you want to play the sound.
	Break Between Plays	Specifies an interval between two plays. You can select 0s, 0.2s, 0.4s, 0.6s, 0.8s, 1s, 2s, 3s, 4s, 5s.

11.6. Alarm Displays

11.6.1. Basic Operations

There are four types of alarm displays.

Type	Description																																																																									
Alarm History	<p>You can display a list of alarm records by using an alarm history display.</p> <table border="1"> <thead> <tr> <th>Date</th> <th>Time</th> <th>Blk Id</th> <th>Level</th> <th>Id</th> <th>Status</th> <th>Message</th> </tr> </thead> <tbody> <tr> <td>03-04-09</td> <td>08:53:50</td> <td>0</td> <td>4</td> <td>L002</td> <td>C</td> <td>Tank #1 level too high</td> </tr> <tr> <td>03-04-09</td> <td>08:53:44</td> <td>0</td> <td>4</td> <td>L002</td> <td>A</td> <td>Tank #1 level too high</td> </tr> <tr> <td>03-04-09</td> <td>08:53:39</td> <td>0</td> <td>3</td> <td>T001</td> <td>C</td> <td>Tank #1 temperature too high</td> </tr> <tr> <td>03-04-09</td> <td>08:53:35</td> <td>0</td> <td>3</td> <td>T001</td> <td>ACK</td> <td>Tank #1 temperature too high</td> </tr> <tr> <td>03-04-09</td> <td>08:53:34</td> <td>0</td> <td>3</td> <td>T001</td> <td>A</td> <td>Tank #1 temperature too high</td> </tr> <tr> <td></td> <td></td> <td></td> <td></td> <td></td> <td></td> <td></td> </tr> </tbody> </table> <p>The above is an example of the alarm history display. The first row is the title row. It displays the title of each column. The other rows display one alarm record per row. You can create scroll button groups or scroll bars to scroll the contents. An alarm history display can have seven columns. The following table describes the content of each column of an alarm record.</p> <table border="1"> <thead> <tr> <th>Column</th> <th>Description</th> </tr> </thead> <tbody> <tr> <td>Date</td> <td>The date when the record is created. This column is optional.</td> </tr> <tr> <td>Time</td> <td>The time when the record is created. This column is optional.</td> </tr> <tr> <td>Alarm Block ID</td> <td>The ID of the alarm block in which the associated alarm is defined. This column is optional.</td> </tr> <tr> <td>Alarm Level</td> <td>The level of the associated alarm. This column is optional.</td> </tr> <tr> <td>Alarm ID</td> <td>The ID of the associated alarm. This column is optional.</td> </tr> <tr> <td>Alarm Status</td> <td> <p>The type of the alarm record. There are three types of alarm records.</p> <table border="1"> <thead> <tr> <th>Type</th> <th>Description</th> </tr> </thead> <tbody> <tr> <td>Active</td> <td>An Active record is created when an alarm is activated.</td> </tr> <tr> <td>ACK</td> <td>An ACK record is created when an alarm is acknowledged.</td> </tr> <tr> <td>CLR</td> <td>A CLR record is created when an alarm is cleared.</td> </tr> </tbody> </table> </td> </tr> <tr> <td>Alarm Message</td> <td>The message of the associated alarm. This column is optional.</td> </tr> </tbody> </table> <p>The text color of a row is determined by the type of the alarm record.</p>	Date	Time	Blk Id	Level	Id	Status	Message	03-04-09	08:53:50	0	4	L002	C	Tank #1 level too high	03-04-09	08:53:44	0	4	L002	A	Tank #1 level too high	03-04-09	08:53:39	0	3	T001	C	Tank #1 temperature too high	03-04-09	08:53:35	0	3	T001	ACK	Tank #1 temperature too high	03-04-09	08:53:34	0	3	T001	A	Tank #1 temperature too high								Column	Description	Date	The date when the record is created. This column is optional.	Time	The time when the record is created. This column is optional.	Alarm Block ID	The ID of the alarm block in which the associated alarm is defined. This column is optional.	Alarm Level	The level of the associated alarm. This column is optional.	Alarm ID	The ID of the associated alarm. This column is optional.	Alarm Status	<p>The type of the alarm record. There are three types of alarm records.</p> <table border="1"> <thead> <tr> <th>Type</th> <th>Description</th> </tr> </thead> <tbody> <tr> <td>Active</td> <td>An Active record is created when an alarm is activated.</td> </tr> <tr> <td>ACK</td> <td>An ACK record is created when an alarm is acknowledged.</td> </tr> <tr> <td>CLR</td> <td>A CLR record is created when an alarm is cleared.</td> </tr> </tbody> </table>	Type	Description	Active	An Active record is created when an alarm is activated.	ACK	An ACK record is created when an alarm is acknowledged.	CLR	A CLR record is created when an alarm is cleared.	Alarm Message	The message of the associated alarm. This column is optional.
Date	Time	Blk Id	Level	Id	Status	Message																																																																				
03-04-09	08:53:50	0	4	L002	C	Tank #1 level too high																																																																				
03-04-09	08:53:44	0	4	L002	A	Tank #1 level too high																																																																				
03-04-09	08:53:39	0	3	T001	C	Tank #1 temperature too high																																																																				
03-04-09	08:53:35	0	3	T001	ACK	Tank #1 temperature too high																																																																				
03-04-09	08:53:34	0	3	T001	A	Tank #1 temperature too high																																																																				
Column	Description																																																																									
Date	The date when the record is created. This column is optional.																																																																									
Time	The time when the record is created. This column is optional.																																																																									
Alarm Block ID	The ID of the alarm block in which the associated alarm is defined. This column is optional.																																																																									
Alarm Level	The level of the associated alarm. This column is optional.																																																																									
Alarm ID	The ID of the associated alarm. This column is optional.																																																																									
Alarm Status	<p>The type of the alarm record. There are three types of alarm records.</p> <table border="1"> <thead> <tr> <th>Type</th> <th>Description</th> </tr> </thead> <tbody> <tr> <td>Active</td> <td>An Active record is created when an alarm is activated.</td> </tr> <tr> <td>ACK</td> <td>An ACK record is created when an alarm is acknowledged.</td> </tr> <tr> <td>CLR</td> <td>A CLR record is created when an alarm is cleared.</td> </tr> </tbody> </table>	Type	Description	Active	An Active record is created when an alarm is activated.	ACK	An ACK record is created when an alarm is acknowledged.	CLR	A CLR record is created when an alarm is cleared.																																																																	
Type	Description																																																																									
Active	An Active record is created when an alarm is activated.																																																																									
ACK	An ACK record is created when an alarm is acknowledged.																																																																									
CLR	A CLR record is created when an alarm is cleared.																																																																									
Alarm Message	The message of the associated alarm. This column is optional.																																																																									

Continued

Type	Description																																		
Alarm Count	<p>You can display a list of the number of occurrences for each alarm by using an alarm count display.</p> <table border="1"> <thead> <tr> <th>Level</th> <th>Id</th> <th>Count</th> <th>Message</th> </tr> </thead> <tbody> <tr> <td>3</td> <td>L001</td> <td>4</td> <td>Tank #1 level too high</td> </tr> <tr> <td>4</td> <td>L002</td> <td>1</td> <td>Tank #1 level too low</td> </tr> <tr> <td>3</td> <td>T001</td> <td>5</td> <td>Tank #1 temperature too high</td> </tr> <tr> <td>4</td> <td>T002</td> <td>3</td> <td>Tank #1 temperature too low</td> </tr> </tbody> </table> <p>The above is an example of an alarm count display. The first row is the title row. It displays the title of each column. The other rows display one alarm per row. You can create scroll button groups or scroll bars to scroll the contents. An alarm count display can have five columns. The following table describes the content of each column of an alarm.</p> <table border="1"> <thead> <tr> <th>Column</th> <th>Description</th> </tr> </thead> <tbody> <tr> <td>Alarm Block ID</td> <td>The ID of the alarm block in which the alarm is defined. This column is optional.</td> </tr> <tr> <td>Alarm Level</td> <td>The level of the alarm. This column is optional.</td> </tr> <tr> <td>Alarm ID</td> <td>The ID of the alarm. This column is optional.</td> </tr> <tr> <td>Alarm Count</td> <td>The number of occurrences of the alarm.</td> </tr> <tr> <td>Alarm Message</td> <td>The message of the alarm. This column is optional.</td> </tr> </tbody> </table> <p>The text color of a row is determined by the level of the alarm.</p>	Level	Id	Count	Message	3	L001	4	Tank #1 level too high	4	L002	1	Tank #1 level too low	3	T001	5	Tank #1 temperature too high	4	T002	3	Tank #1 temperature too low	Column	Description	Alarm Block ID	The ID of the alarm block in which the alarm is defined. This column is optional.	Alarm Level	The level of the alarm. This column is optional.	Alarm ID	The ID of the alarm. This column is optional.	Alarm Count	The number of occurrences of the alarm.	Alarm Message	The message of the alarm. This column is optional.		
Level	Id	Count	Message																																
3	L001	4	Tank #1 level too high																																
4	L002	1	Tank #1 level too low																																
3	T001	5	Tank #1 temperature too high																																
4	T002	3	Tank #1 temperature too low																																
Column	Description																																		
Alarm Block ID	The ID of the alarm block in which the alarm is defined. This column is optional.																																		
Alarm Level	The level of the alarm. This column is optional.																																		
Alarm ID	The ID of the alarm. This column is optional.																																		
Alarm Count	The number of occurrences of the alarm.																																		
Alarm Message	The message of the alarm. This column is optional.																																		
Active Alarm	<p>You can display a list of active alarms by using an active alarm display.</p> <table border="1"> <thead> <tr> <th>Date</th> <th>Time</th> <th>Id</th> <th>Message</th> </tr> </thead> <tbody> <tr> <td>03-05-09</td> <td>04:39:54</td> <td>L002</td> <td>Tank #1 level too low</td> </tr> <tr> <td>03-05-09</td> <td>04:39:51</td> <td>T001</td> <td>Tank #1 temperature too high</td> </tr> <tr> <td></td> <td></td> <td></td> <td></td> </tr> <tr> <td></td> <td></td> <td></td> <td></td> </tr> </tbody> </table> <p>The above is an example of an active alarm display. The first row is the title row. It displays the title of each column. The other rows display one active alarm per row. You can create scroll button groups or scroll bars to scroll the contents. An active alarm display can have six columns. The following table describes the content of each column for an active alarm.</p> <table border="1"> <thead> <tr> <th>Column</th> <th>Description</th> </tr> </thead> <tbody> <tr> <td>Date</td> <td>The date when the alarm is activated.</td> </tr> <tr> <td>Time</td> <td>The time when the alarm is activated.</td> </tr> <tr> <td>Alarm Block ID</td> <td>The ID of the alarm block in which the alarm is defined. This column is optional.</td> </tr> <tr> <td>Alarm Level</td> <td>The level of the alarm. This column is optional.</td> </tr> <tr> <td>Alarm ID</td> <td>The ID of the alarm. This column is optional.</td> </tr> <tr> <td>Alarm Message</td> <td>The message of the alarm. This column is optional.</td> </tr> </tbody> </table> <p>The text color of a row is determined by the level of the alarm.</p>	Date	Time	Id	Message	03-05-09	04:39:54	L002	Tank #1 level too low	03-05-09	04:39:51	T001	Tank #1 temperature too high									Column	Description	Date	The date when the alarm is activated.	Time	The time when the alarm is activated.	Alarm Block ID	The ID of the alarm block in which the alarm is defined. This column is optional.	Alarm Level	The level of the alarm. This column is optional.	Alarm ID	The ID of the alarm. This column is optional.	Alarm Message	The message of the alarm. This column is optional.
Date	Time	Id	Message																																
03-05-09	04:39:54	L002	Tank #1 level too low																																
03-05-09	04:39:51	T001	Tank #1 temperature too high																																
Column	Description																																		
Date	The date when the alarm is activated.																																		
Time	The time when the alarm is activated.																																		
Alarm Block ID	The ID of the alarm block in which the alarm is defined. This column is optional.																																		
Alarm Level	The level of the alarm. This column is optional.																																		
Alarm ID	The ID of the alarm. This column is optional.																																		
Alarm Message	The message of the alarm. This column is optional.																																		

Continued

Type	Description								
Alarm Marquee	<p>You can display and scroll the messages of the active alarms by using an alarm marquee.</p> <div style="border: 1px solid black; padding: 5px; margin: 10px 0;"> <p style="margin: 0;">4 L002 Tank #1 level too high 3 T001 Tank #1 temperature too high</p> </div> <p>The above is an example of an alarm marquee. You can place the following texts in front of the alarm messages.</p> <table border="1" style="width: 100%; border-collapse: collapse;"> <thead> <tr> <th style="width: 25%;">Text</th> <th>Description</th> </tr> </thead> <tbody> <tr> <td>Alarm Block ID</td> <td>The ID of the alarm block in which the alarm is defined.</td> </tr> <tr> <td>Alarm Level</td> <td>The level of the alarm.</td> </tr> <tr> <td>Alarm ID</td> <td>The ID of the alarm.</td> </tr> </tbody> </table> <p>The text color for an alarm is determined by the level of that alarm.</p>	Text	Description	Alarm Block ID	The ID of the alarm block in which the alarm is defined.	Alarm Level	The level of the alarm.	Alarm ID	The ID of the alarm.
Text	Description								
Alarm Block ID	The ID of the alarm block in which the alarm is defined.								
Alarm Level	The level of the alarm.								
Alarm ID	The ID of the alarm.								

Note: You can sort the list of an alarm display at runtime by touching the title of the column that you want to be the sort field. Touching the same title again changes the sort order from ascending to descending, or vice versa. The columns that can be a sort field include: Date, Time, Alarm Block ID, Alarm Level, Alarm ID, Alarm Status, and Alarm Count.

11.6.2. Operation Options

The following operation options can be added to an alarm display. Select and set the option in the Alarm Display dialog box.

Options	Description
Visibility Control	You can show and hide an alarm display with a specified bit or the current user level. Select and set this option in the Visibility page.

11.6.3. Settings

You can complete all the settings of an alarm display in the Alarm Display dialog box. This dialog box contains the following two pages.

- **General**
Described in [Section 11.6.4.](#)
- **Query**
Described in [Section 11.6.5.](#)
- **Visibility**
Described in [Section 4.4.6.](#)

11.6.4. General Settings

This section describes how to define the general settings for an alarm display. The following is an example of the General page of the Alarm Display dialog box.

The following table describes each property in the General page of the Alarm Display dialog box.

Property	Description
ID	The object's identifier. It is generated when the object is created. The identifier is unique within the screen where the object is located and is unchangeable. The format of the IDs for the alarm displays is ADnnnn.
Note	You can type a note for the object.
Shape settings	For details about the following properties, see Section 4.3.4 Setting up the Shape of an Object. <input type="button" value="Shape..."/> , Border Color, BG Color

Continued

Property		Description											
Type		Specifies the type of the alarm display. There are four types:											
		<table border="1"> <thead> <tr> <th>Type</th> <th>Description</th> </tr> </thead> <tbody> <tr> <td>Alarm History</td> <td>The alarm history display lists the alarm records.</td> </tr> <tr> <td>Alarm Count</td> <td>The alarm count display lists the number of occurrences of each alarm.</td> </tr> <tr> <td>Active Alarm</td> <td>The active alarm display lists the active alarms.</td> </tr> <tr> <td>Alarm Marquee</td> <td>The alarm marquee scrolls the messages of the active alarms horizontally.</td> </tr> </tbody> </table>		Type	Description	Alarm History	The alarm history display lists the alarm records.	Alarm Count	The alarm count display lists the number of occurrences of each alarm.	Active Alarm	The active alarm display lists the active alarms.	Alarm Marquee	The alarm marquee scrolls the messages of the active alarms horizontally.
		Type	Description										
		Alarm History	The alarm history display lists the alarm records.										
		Alarm Count	The alarm count display lists the number of occurrences of each alarm.										
Active Alarm	The active alarm display lists the active alarms.												
Alarm Marquee	The alarm marquee scrolls the messages of the active alarms horizontally.												
Scrolling Speed	Select a speed for the alarm display when the Type is Alarm Marquee.												
Direction	Select Leftward or Rightward for the alarm display when the Type is Alarm Marquee.												
Grid	Vertical	Select this option if you want the alarm display to have vertical grids.											
	Horizontal	Select this option if you want the alarm display to have horizontal grids.											
	Color	Select a color for the grids.											
Alarm Block		Select an alarm block so that the alarm display will show the alarms defined in that alarm block only. Select All if you want the alarm display to show all the alarms.											
Title	<Check Box>	Select this option if you want the alarm display to have a title row to show the title for each column of the displayed list when the Type is Alarm History, Alarm Count, or Current Alarm.											
	Language	Select a language so you can view and edit the settings of the title row for that language.											
	Font	Select a font for the title text.											
	Color	Select a color for the text.											
	BG Color	Select a color for the title row.											
	Date	Specifies the title for the Date column. This field is available when the Type is Alarm History or Current Alarm.											
	Time	Specifies the title for the Time column. This field is available when the Type is Alarm History or Current Alarm.											
	Alarm Block ID	Specifies the title for the Alarm Block ID column.											
	Alarm Level	Specifies the title for the Alarm Level column.											
	Alarm ID	Specifies the title for the Alarm ID column.											
	Alarm Status	Specifies the title for the Alarm Status column. This field is available when the Type is Alarm History.											
	Alarm Count	Specifies the title for the Alarm Count column. This field is available when the Type is Alarm Count.											
	Alarm Message	Specifies the title for the Alarm Message column.											

Continued

Property		Description	
Text	Sort Type	Specifies how the alarm display initially sorts its list. This field is available when the Type is not Alarm Marquee. Note: When you want an alarm display to sort its list by the contents of a column at runtime, simply touch the title of that column and the alarm display will sort its list right away.	
	Language	Select a language so you can view and edit the language dependent settings in the Text group for that language. The language dependent properties in the Text group include Font and Alarm Status Abbreviation.	
	Font	Select a font for the text.	
	Date	<Check Box>	Check this option if you want the alarm display to have the Date column. This field is available when the Type is Alarm History.
		<Drop-down List>	Select a format for displaying the date
	Time	<Check Box>	Check this option if you want the alarm display to have the Time column. This field is available when the Type is Alarm History.
		<Drop-down List>	Select a format for displaying the time
	Alarm Block ID	Check this option if you want the alarm display to have the Alarm Block ID column.	
	Alarm Level	Check this option if you want the alarm display to have the Alarm Level column.	
	Alarm ID	Check this option if you want the alarm display to have the Alarm ID column.	
	Alarm Message	Check this option if you want the alarm display to have the Alarm Message column.	
	Cleared Alarms	Check this option so the alarm display will show the records of cleared alarms. This field is available when the Type is Alarm History.	
	Alarm ACK	Check this option so the alarm display will show the records of acknowledged alarms. This field is available when the Type is Alarm History.	
	Sequence Number	Check this option so the alarm display will show the sequence numbers of the alarm records. This field is available when the Type is Alarm History.	
Alarm Status Abbreviation	Active	Enter up to 3 characters that will be shown in the Alarm Status column for the alarm records that record when an alarm occurs. This field is available when the Type is Alarm History.	
	Cleared	Enter up to 3 characters that will be shown in the Alarm Status column for the alarm records that record when an alarm is cleared. This field is available when the Type is Alarm History.	
	ACK	Enter up to 3 characters that will be shown in the Alarm Status column for the alarm records that record when an alarm is acknowledged. This field is available when the Type is Alarm History.	
Line Spacing	Specifies the extra space in pixels for two adjacent rows of the alarm display. This field is available when the Type is not Alarm Marquee.		
Item Spacing	Specifies the extra space for every column of the alarm display. This field is available when the Type is not Alarm Marquee.		
Alarm Message Color		Click the button to replace the selections of the L1 to L8 fields by the default alarm message colors defined in the Alarm Properties dialog box. This button is available when the Type is not Alarm History.	
	L1,L2 ... L8	Select a color for alarm level 1, 2...8. The alarm display will show an alarm message with this color if that alarm is defined as a level 1, 2...8 alarm. This field is available when the Type is not Alarm History.	
	Active	Select a color for displaying the alarm records that record when an alarm occurs. This field is available when the Type is Alarm History.	
	Cleared	Select a color for displaying the alarm records that record when an alarm is cleared. This field is available when the Type is Alarm History.	
	ACK	Select a color for displaying the alarm records that record when an alarm is acknowledged. This field is available when the Type is Alarm History.	

11.6.5. Query Settings

This section describes how to query alarms. The following is an example of the Query page of the Alarm Display dialog box.

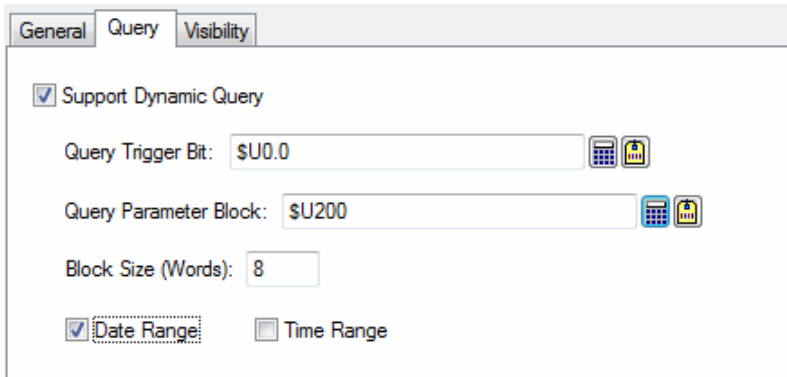

The following table describes each property in the Query page of the Alarm Display dialog box.

Property	Description																				
Support Dynamic Query	When this option is selected, the object can display the alarm records to answer the query specified in the Query Parameter Block.																				
Query Trigger Bit	Specifies the bit that will trigger the query operation at runtime. The HMI reads the Query Parameter Block and refreshes the object according to the current query whenever the Query Trigger Bit changes from Off to On. Click to enter the bit address. Click to enter the bit tag.																				
Query Parameter Block	Specifies the location that stores the query parameters. Click to enter an address for this field. Click to select a tag for this field. The following table shows the data arrangement of the parameter block.																				
	<table border="1"> <thead> <tr> <th>Word</th> <th>Description</th> </tr> </thead> <tbody> <tr> <td>0</td> <td>The query flags. <table border="1"> <thead> <tr> <th>Bit</th> <th>Description</th> </tr> </thead> <tbody> <tr> <td>0</td> <td>Query the alarm records of the specified alarm number when the bit is on. The alarm number is specified in word 1 of the Query Parameter Block.</td> </tr> <tr> <td>1</td> <td>Query the alarm records that occurred within the specified duration when the bit is on. The date range is specified in word 2-7 of the Query Parameter Block. The time range is specified in word 8-13 of the Query Parameter Block.</td> </tr> </tbody> </table> <p>Note: When both query flags are on, the answer will fulfill both query conditions.</p> </td> </tr> <tr> <td>1</td> <td>The alarm number.</td> </tr> <tr> <td>2,3,4</td> <td>The start date of the date range. Year(word 2): 1~99; Month(word 3): 1~12; Day(word 4): 1~31</td> </tr> <tr> <td>5,6,7</td> <td>The end date of the date range. Year(word 5): 1~99; Month(word 6): 1~12; Day(word 7): 1~31</td> </tr> <tr> <td>8,9,10</td> <td>The start time of the time range. Hour(word 8): 0~23; Minute(word 9): 0~59; Second(word 10): 0~59</td> </tr> <tr> <td>11,12,13</td> <td>The end time of the time range. Hour(word 11): 0~23; Minute(word 12): 0~59; Second(word 13): 0~59</td> </tr> </tbody> </table>	Word	Description	0	The query flags. <table border="1"> <thead> <tr> <th>Bit</th> <th>Description</th> </tr> </thead> <tbody> <tr> <td>0</td> <td>Query the alarm records of the specified alarm number when the bit is on. The alarm number is specified in word 1 of the Query Parameter Block.</td> </tr> <tr> <td>1</td> <td>Query the alarm records that occurred within the specified duration when the bit is on. The date range is specified in word 2-7 of the Query Parameter Block. The time range is specified in word 8-13 of the Query Parameter Block.</td> </tr> </tbody> </table> <p>Note: When both query flags are on, the answer will fulfill both query conditions.</p>	Bit	Description	0	Query the alarm records of the specified alarm number when the bit is on. The alarm number is specified in word 1 of the Query Parameter Block.	1	Query the alarm records that occurred within the specified duration when the bit is on. The date range is specified in word 2-7 of the Query Parameter Block. The time range is specified in word 8-13 of the Query Parameter Block.	1	The alarm number.	2,3,4	The start date of the date range. Year(word 2): 1~99; Month(word 3): 1~12; Day(word 4): 1~31	5,6,7	The end date of the date range. Year(word 5): 1~99; Month(word 6): 1~12; Day(word 7): 1~31	8,9,10	The start time of the time range. Hour(word 8): 0~23; Minute(word 9): 0~59; Second(word 10): 0~59	11,12,13	The end time of the time range. Hour(word 11): 0~23; Minute(word 12): 0~59; Second(word 13): 0~59
Word	Description																				
0	The query flags. <table border="1"> <thead> <tr> <th>Bit</th> <th>Description</th> </tr> </thead> <tbody> <tr> <td>0</td> <td>Query the alarm records of the specified alarm number when the bit is on. The alarm number is specified in word 1 of the Query Parameter Block.</td> </tr> <tr> <td>1</td> <td>Query the alarm records that occurred within the specified duration when the bit is on. The date range is specified in word 2-7 of the Query Parameter Block. The time range is specified in word 8-13 of the Query Parameter Block.</td> </tr> </tbody> </table> <p>Note: When both query flags are on, the answer will fulfill both query conditions.</p>	Bit	Description	0	Query the alarm records of the specified alarm number when the bit is on. The alarm number is specified in word 1 of the Query Parameter Block.	1	Query the alarm records that occurred within the specified duration when the bit is on. The date range is specified in word 2-7 of the Query Parameter Block. The time range is specified in word 8-13 of the Query Parameter Block.														
Bit	Description																				
0	Query the alarm records of the specified alarm number when the bit is on. The alarm number is specified in word 1 of the Query Parameter Block.																				
1	Query the alarm records that occurred within the specified duration when the bit is on. The date range is specified in word 2-7 of the Query Parameter Block. The time range is specified in word 8-13 of the Query Parameter Block.																				
1	The alarm number.																				
2,3,4	The start date of the date range. Year(word 2): 1~99; Month(word 3): 1~12; Day(word 4): 1~31																				
5,6,7	The end date of the date range. Year(word 5): 1~99; Month(word 6): 1~12; Day(word 7): 1~31																				
8,9,10	The start time of the time range. Hour(word 8): 0~23; Minute(word 9): 0~59; Second(word 10): 0~59																				
11,12,13	The end time of the time range. Hour(word 11): 0~23; Minute(word 12): 0~59; Second(word 13): 0~59																				
Block Size (Words)	The size in word of query parameter block.																				
Date Range	Check this option if you want the object to display the alarms that occur in the specified date range.																				
Time Range	Check this option if you want the object to display the alarms that occur in the specified time range.																				

CHAPTER 12

DATA COLLECTION AND HISTORIC DISPLAYS

12.1. Data Logger.....	1
12.1.1. Settings	1
12.1.2. General Settings.....	2
12.1.3. Data Item Settings.....	5
12.1.4. Using LDF File to Save Logged Data	7
12.2. Displaying Logged Data Values Using Historic Data Tables.....	8
12.2.1. Basic Operations	8
12.2.2. Operation Options.....	8
12.2.3. Settings	8
12.2.4. General Settings.....	9
12.2.5. Data Item Settings.....	11
12.3. Displaying Logged Data Trend Using Historic Trend Graph	12
12.3.1. Basic Operations.....	12
12.3.2. Operation Options.....	12
12.3.3. Settings	12
12.3.4. General Settings.....	13
12.3.5. Curve Settings.....	15
12.3.6. Axis Settings.....	16
12.4. Displaying History of Predefined Events Using Historic Event Tables	18
12.4.1. Basic Operations.....	18
12.4.2. Operation Options.....	18
12.4.3. Settings	19
12.4.4. General Settings.....	20
12.4.5. Message Settings	22
12.5. Displaying Time Slice Data Profile Using Single Record Line Charts .	23
12.5.1. Basic Operations.....	23
12.5.2. Operation Options.....	24
12.5.3. Settings	24
12.5.4. General Settings.....	25
12.5.5. Pen Settings	27
12.5.6. Axis Settings.....	29

This chapter describes how to set up data loggers for your application to collect data, and how to configure the historic display objects to display the collected data.

12.1. Data Logger

A data logger can collect and store the values of a data block. You can specify what data block you want to log, determine the frequency of data sampling, choose the type of memory to save the logged data, and specify how to save the logged data to files.

You can create up to 16 data loggers for your application. The maximum size of the data block that can be sampled by a data logger is 128 words.

You can use the function button to request the panel to clear logged data, or save/load logged data (.ldf/.txt file). To know how to define a function button, please see [Section 5.4.1 Basic Operations](#) of function buttons.

To create a data logger, you may do one of the following:

- 1) In the Project Manager tool window, right-click the Data Loggers node of the concerned panel application and select Add Data Logger.
- 2) In the menu bar, click Panel to bring up the Panel sub-menu. Click Data Logger in the Panel sub-menu to bring up the Data Logger pop-up menu. Select Add in the pop-up menu.

12.1.1. Settings

You can set up a data logger with the Data Logger dialog box. There are two ways to open the dialog box of a data logger:

- 1) In the Project Manager window, right-click the node of the desired data logger and select Properties.
- 2) In the menu bar, click Panel to bring up the Panel sub-menu. Click Data Logger in the Panel sub-menu to bring up the Data Logger pop-up menu. Select Properties in the pop-up menu to bring up the data logger list of the current panel application. Select the data logger in the list.

The Data Logger dialog box contains the following two pages:

- **General**

Described in [Section 12.1.2.](#)

- **Data Item**

Described in [Section 12.1.3.](#)



12.1.2. General Settings

Use the General page to define the general settings for a data logger. The following is an example of the General page.

The table below describes each property in the General page.

Property	Description
Name	The data logger's name. The maximum length of the name is 48 characters.
ID	The data logger's ID number. Select a number between 1 and 16. The number is unique among all data loggers of the panel application.
Use battery backed RAM	Check this option so the logging buffer of the data logger will be located in the battery backed RAM. The logged data will not be lost after power down if the battery backed RAM is used as the logging buffer. If this option is not selected, the logging buffer will be located in an ordinary RAM, and the data logger will clear the logging buffer whenever the target panel is powered up.
Sample Size	The size of the data to be sampled. The unit is word.
Number of Samples	Specifies the maximum number of samples that the logging buffer of the data logger can hold.
Logging Buffer Size	The size of the logging buffer. The unit is word. The formula to calculate the size is: Logging Buffer Size = Number of Samples * (Sample Size + 5)
Latest Sampled Data	Word Address You can use the addresses shown here to refer to the latest sampled data of the data logger for configuring screen objects and writing macros.
Read Address	Specifies the variable representing the data block to be sampled. Click to enter an address for this field. Click to select a tag for this field. The size of the data block is specified in the Sample Size field.

Continued

Property		Description	
Sampling Method	Timed	The data logger samples data periodically at a rate specified in the Interval field. You can specify an interval between 1 and 65535 seconds for the Interval field. For example, if you want the data logger to sample data every 5 seconds, specify 5 for the Interval field.	
	Triggered	The data logger samples data once whenever the trigger bit specified in the Trigger Bit field changes from Off to On.	
	Clocked	The data logger samples data at fixed moments specified in the At Each field. There are six sets of fixed moments available for the At Each field.	
		At Each	Fixed Moments
		1x	Every minute at 0 second
		5x	The following moments of every hour: 00:00, 05:00, 10:00, 15:00, 20:00, 25:00, 30:00, 35:00, 40:00, 45:00, 50:00, 55:00
10x		The following moments of every hour: 00:00, 10:00, 20:00, 30:00, 40:00, 50:00	
15x		The following moments of every hour: 00:00, 15:00, 30:00, 45:00	
30x		The following moments of every hour: 00:00, 30:00	
60x	Every hour on the hour		
Timed (sub-second)	The data logger samples data periodically at a rate specified in the Interval field. You can select an interval between 0.1 and 0.9 seconds for the Interval field. For example, if you want the data logger to sample data every 0.5 seconds, select 0.5 for the Interval field. The sub-second sampling requires high data acquisition performance. As there are many factors that can affect performance, it is not guaranteed that the specified sampling rate can be attained.		
Load from .LDF File	The data logger does not sample data. It receives the data loaded from an LDF file.		
Sample Full Processing	Stop Sampling	Check the option if you want the data logger to stop sampling data when the logging buffer is full.	
	Notify	Check the option if you want the data logger to set the bit specified in the Bit field to On when the number of collected samples exceeds the limit specified in the Full Limit field.	
	Bit	Available when the Notify field is checked. Specifies the bit for the sample full notification. Click  to enter an address for this field. Click  to select a tag for this field.	
	Full Limit	Available when the Notify field is checked. Select a percentage as the full limit. When the ratio of collected samples to maximum samples specified in the Number of Samples field exceeds the percentage, the data logger sets the bit specified in the Bit field to On.	
External Control	Clear Buffer	Check this option so the data logger can be controlled to clear its logging buffer with the trigger bit specified in the Trigger Bit field.	
	Trigger Bit	Available when the Clear Buffer option is checked. Select a trigger bit that will control the data logger to clear its logging buffer. The data logger clears its logging buffer when the trigger bit changes from Off to On.	
	Enable Sampling	Check this option so the data logger can be enabled and disabled by the enabling bit specified in the Enabling Bit field.	
	Enabling Bit	Available when the Enable Sampling option is checked. Select an enabling bit that will enable and disable the data logger. The data logger is enabled when the enabling bit is On.	

Continued

Property		Description														
Save Data to File	Save Data to File	Check this option so the data logger will periodically write the newly collected data to a specified file. Each time the data logger performs this operation, it writes only the data that have not saved to a file before.														
	File Type	The type of file to save the logged data.														
		<table border="1"> <thead> <tr> <th>File Type</th> <th>Description</th> </tr> </thead> <tbody> <tr> <td>.CSV/.TXT</td> <td>The logged data are saved in CSV or text format. You can use any text editor to view the logged data. Most importantly you can use Microsoft Excel to import the logged data from such files directly.</td> </tr> <tr> <td>.LDF</td> <td>The logged data are saved in a binary format and can only be used by a data logger that has exactly the same data definition. This file type allows you to view and operate historic data loaded from files.</td> </tr> </tbody> </table>	File Type	Description	.CSV/.TXT	The logged data are saved in CSV or text format. You can use any text editor to view the logged data. Most importantly you can use Microsoft Excel to import the logged data from such files directly.	.LDF	The logged data are saved in a binary format and can only be used by a data logger that has exactly the same data definition. This file type allows you to view and operate historic data loaded from files.								
		File Type	Description													
	.CSV/.TXT	The logged data are saved in CSV or text format. You can use any text editor to view the logged data. Most importantly you can use Microsoft Excel to import the logged data from such files directly.														
	.LDF	The logged data are saved in a binary format and can only be used by a data logger that has exactly the same data definition. This file type allows you to view and operate historic data loaded from files.														
	Operation Type	Specifies how to open a file to save the logged data.														
	<table border="1"> <thead> <tr> <th>Operation Type</th> <th>Description</th> </tr> </thead> <tbody> <tr> <td>Create</td> <td>Creates a new file with the specified filename to save the logged data.</td> </tr> <tr> <td>Append or Create</td> <td>If the specified file exists, appends the logged data to that file; otherwise creates a new file with the specified filename to save the logged data.</td> </tr> </tbody> </table>	Operation Type	Description	Create	Creates a new file with the specified filename to save the logged data.	Append or Create	If the specified file exists, appends the logged data to that file; otherwise creates a new file with the specified filename to save the logged data.									
Operation Type	Description															
Create	Creates a new file with the specified filename to save the logged data.															
Append or Create	If the specified file exists, appends the logged data to that file; otherwise creates a new file with the specified filename to save the logged data.															
Time to Save	Specifies the period to save the logged data. There are nine periods available:															
	<table border="1"> <thead> <tr> <th>Available Period</th> </tr> </thead> <tbody> <tr> <td>Every hour on the hour</td> </tr> <tr> <td>Every 8 hours (00:00, 08:00, 16:00)</td> </tr> <tr> <td>Every 12 hours (00:00, 12:00)</td> </tr> <tr> <td>Every day at 00:00</td> </tr> <tr> <td>Every day at 08:00</td> </tr> <tr> <td>Every day at 12:00</td> </tr> <tr> <td>Every Sunday at 00:00</td> </tr> <tr> <td>Every Monday at 00:00</td> </tr> <tr> <td>Every month's first day at 00:00</td> </tr> </tbody> </table>	Available Period	Every hour on the hour	Every 8 hours (00:00, 08:00, 16:00)	Every 12 hours (00:00, 12:00)	Every day at 00:00	Every day at 08:00	Every day at 12:00	Every Sunday at 00:00	Every Monday at 00:00	Every month's first day at 00:00					
Available Period																
Every hour on the hour																
Every 8 hours (00:00, 08:00, 16:00)																
Every 12 hours (00:00, 12:00)																
Every day at 00:00																
Every day at 08:00																
Every day at 12:00																
Every Sunday at 00:00																
Every Monday at 00:00																
Every month's first day at 00:00																
Filename	The filename or the prefix of the filename of the file to save the logged data. The extension name must be ".txt" when the File Type is ".TXT". The extension name must be ".ldf" when the File Type is ".LDF".															
Filename Suffix	Available when the Operation Type is Create. This property guarantees that the created file has a unique name and no existing file will be overwritten. There are four kinds of filename suffixes available as shown in the following table.															
	<table border="1"> <thead> <tr> <th>Filename Suffix</th> <th>Description</th> <th>Example</th> </tr> </thead> <tbody> <tr> <td>_YYMMDD_hhmmss</td> <td>YY: year (00-99) MM: month (01-12) DD: day (01-31) hh: hour (00-23) mm: minute (00-59) ss: second (00-59)</td> <td>Log_090423_102358 (Assume that the specified Filename is "Log", the current date is April 23, 2009, and the current time is 10:23:58.)</td> </tr> <tr> <td>_YYMMDD_hhmm</td> <td>See above</td> <td>Log_090423_1023</td> </tr> <tr> <td>_YYMMDD_hh</td> <td>See above</td> <td>Log_090423_10</td> </tr> <tr> <td>_YYMMDD</td> <td>See above</td> <td>Log_090423</td> </tr> </tbody> </table>	Filename Suffix	Description	Example	_YYMMDD_hhmmss	YY: year (00-99) MM: month (01-12) DD: day (01-31) hh: hour (00-23) mm: minute (00-59) ss: second (00-59)	Log_090423_102358 (Assume that the specified Filename is "Log", the current date is April 23, 2009, and the current time is 10:23:58.)	_YYMMDD_hhmm	See above	Log_090423_1023	_YYMMDD_hh	See above	Log_090423_10	_YYMMDD	See above	Log_090423
Filename Suffix	Description	Example														
_YYMMDD_hhmmss	YY: year (00-99) MM: month (01-12) DD: day (01-31) hh: hour (00-23) mm: minute (00-59) ss: second (00-59)	Log_090423_102358 (Assume that the specified Filename is "Log", the current date is April 23, 2009, and the current time is 10:23:58.)														
_YYMMDD_hhmm	See above	Log_090423_1023														
_YYMMDD_hh	See above	Log_090423_10														
_YYMMDD	See above	Log_090423														

12.1.3. Data Item Settings

Use the Data Item page to define the data items of the sampled data for a data logger. The following is an example of the Data Item page.

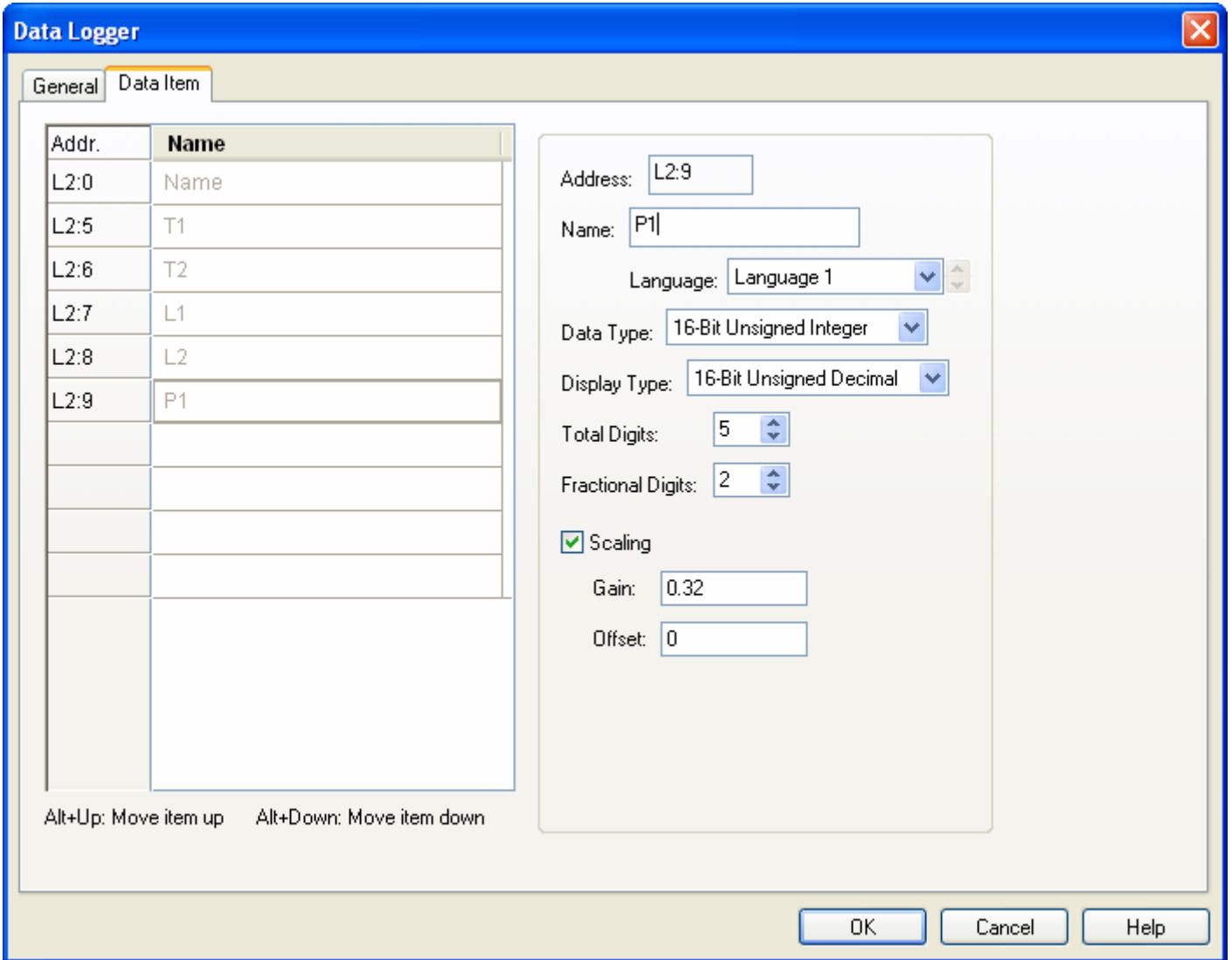

The Data Item page contains two parts. The left part is the data item list that shows the address and name of each data item in rows. The right part shows the properties of the selected data item. To select a data item, click the row of that data item in the data item list.

The following table describes each property of the data item.

Property	Description
Address	You can use the address shown here to refer to the latest sampled value of the data item.
Name	Specifies the name of the data item for the language specified in the Language field.
Language	Select a language so you can view and edit the name of the data item for that language.
Data Type	The data type of the data item. The supported data types include: 16-Bit Unsigned Integer, 32-Bit Unsigned Integer, 16-Bit Signed Integer, 32-Bit Signed Integer, 16-Bit BCD, 32-Bit BCD, 32-Bit Floating Point, ASCII String, and Unicode String.

Continued

Property	Description																									
Display Type	<p>The display type for the value of the data item. The following table shows the available display types for each data type.</p> <table border="1"> <thead> <tr> <th>Data Type</th> <th>Available Display Types</th> </tr> </thead> <tbody> <tr> <td>16-Bit Unsigned Integer</td> <td>16-Bit Unsigned Decimal, 16-Bit Hexadecimal, 16-Bit Octal</td> </tr> <tr> <td>32-Bit Unsigned Integer</td> <td>32-Bit Unsigned Decimal, 32-Bit Hexadecimal, 32-Bit Octal</td> </tr> <tr> <td>16-Bit Signed Integer</td> <td>16-Bit Signed Decimal</td> </tr> <tr> <td>32-Bit Signed Integer</td> <td>32-Bit Signed Decimal</td> </tr> <tr> <td>16-Bit BCD</td> <td>16-Bit Unsigned Decimal</td> </tr> <tr> <td>32-Bit BCD</td> <td>32-Bit Unsigned Decimal</td> </tr> <tr> <td>32-Bit Floating Point</td> <td>32-Bit Floating Point</td> </tr> <tr> <td>ASCII String</td> <td>ASCII String</td> </tr> <tr> <td>Unicode String</td> <td>Unicode String</td> </tr> </tbody> </table>	Data Type	Available Display Types	16-Bit Unsigned Integer	16-Bit Unsigned Decimal, 16-Bit Hexadecimal, 16-Bit Octal	32-Bit Unsigned Integer	32-Bit Unsigned Decimal, 32-Bit Hexadecimal, 32-Bit Octal	16-Bit Signed Integer	16-Bit Signed Decimal	32-Bit Signed Integer	32-Bit Signed Decimal	16-Bit BCD	16-Bit Unsigned Decimal	32-Bit BCD	32-Bit Unsigned Decimal	32-Bit Floating Point	32-Bit Floating Point	ASCII String	ASCII String	Unicode String	Unicode String					
Data Type	Available Display Types																									
16-Bit Unsigned Integer	16-Bit Unsigned Decimal, 16-Bit Hexadecimal, 16-Bit Octal																									
32-Bit Unsigned Integer	32-Bit Unsigned Decimal, 32-Bit Hexadecimal, 32-Bit Octal																									
16-Bit Signed Integer	16-Bit Signed Decimal																									
32-Bit Signed Integer	32-Bit Signed Decimal																									
16-Bit BCD	16-Bit Unsigned Decimal																									
32-Bit BCD	32-Bit Unsigned Decimal																									
32-Bit Floating Point	32-Bit Floating Point																									
ASCII String	ASCII String																									
Unicode String	Unicode String																									
Total Digits	Specifies the number of digits to be displayed for the value of the data item.																									
Fractional Digits	<p>Specifies how to display the fractional part of the value of the data item. When the Display Type is 32-bit Floating Point, this property specifies the number of fractional digits to be displayed. When the Display Type is not 32-bit Floating Point, this property specifies not only the number of fractional digits to be displayed, but also the number of least significant digits to be displayed as the fractional part. With this feature, an integer can be shown as a fixed point number.</p> <p>Example:</p> <table border="1"> <thead> <tr> <th>Display Type</th> <th>Total Digits</th> <th>Fractional Digits</th> <th>Sampled Value</th> <th>Displayed Value</th> </tr> </thead> <tbody> <tr> <td>32-bit Floating Point</td> <td>4</td> <td>2</td> <td>12.34</td> <td>12.34</td> </tr> <tr> <td>32-bit Floating Point</td> <td>4</td> <td>2</td> <td>123.4</td> <td>23.40</td> </tr> <tr> <td>16-bit Signed Decimal</td> <td>5</td> <td>2</td> <td>12345</td> <td>123.45</td> </tr> <tr> <td>16-bit Signed Decimal</td> <td>5</td> <td>2</td> <td>-5</td> <td>-0.05</td> </tr> </tbody> </table>	Display Type	Total Digits	Fractional Digits	Sampled Value	Displayed Value	32-bit Floating Point	4	2	12.34	12.34	32-bit Floating Point	4	2	123.4	23.40	16-bit Signed Decimal	5	2	12345	123.45	16-bit Signed Decimal	5	2	-5	-0.05
Display Type	Total Digits	Fractional Digits	Sampled Value	Displayed Value																						
32-bit Floating Point	4	2	12.34	12.34																						
32-bit Floating Point	4	2	123.4	23.40																						
16-bit Signed Decimal	5	2	12345	123.45																						
16-bit Signed Decimal	5	2	-5	-0.05																						
Scaling	<p>Check this option if you want the value of the data item to be displayed in a scaled manner. The following is the scaling formula:</p> $\text{DisplayedValue} = \text{SampledValue} * \text{Gain} + \text{Offset}$ <p>Note: The <i>Gain</i> and <i>Offset</i> are 32-bit floating point numbers. They have at most 6 significant digits. Rounding and truncation errors may occur.</p>																									
Gain	Available when the Scaling option is checked. Specifies the <i>Gain</i> used in the scaling formula.																									
Offset	Available when the Scaling option is checked. Specifies the <i>Offset</i> used in the scaling formula.																									

12.1.4. Using LDF File to Save Logged Data

The LDF files allow you to save logged data in files and view the data later. Hence, the size of the battery backed RAM or the buffer sizes of the data loggers will not limit the size of the historical data you want to collect.

There are three ways to write the logged data of a data logger to an LDF file:

- 1) You can use a function button to perform “Copy Logged Data To .LDF File”. The button writes all the logged data of the specified data logged to an LDF file.
- 2) You can use the Command Block to request this operation.
- 3) You can configure a data logger to write its collected data to an LDF file automatically with preset time intervals.

To view the logged data of an LDF file, you need to load the data of that LDF file into a data logger first. A data logger is able to receive the data from an LDF file only when:

- 1) The definitions of the data items of the LDF file and the data logger are identical, and
- 2) The number of samples of the LDF file is not greater than the number of samples of the data logger.

The viewing objects for an LDF file should be configured for the data logger that is able to receive the data from that LDF file.

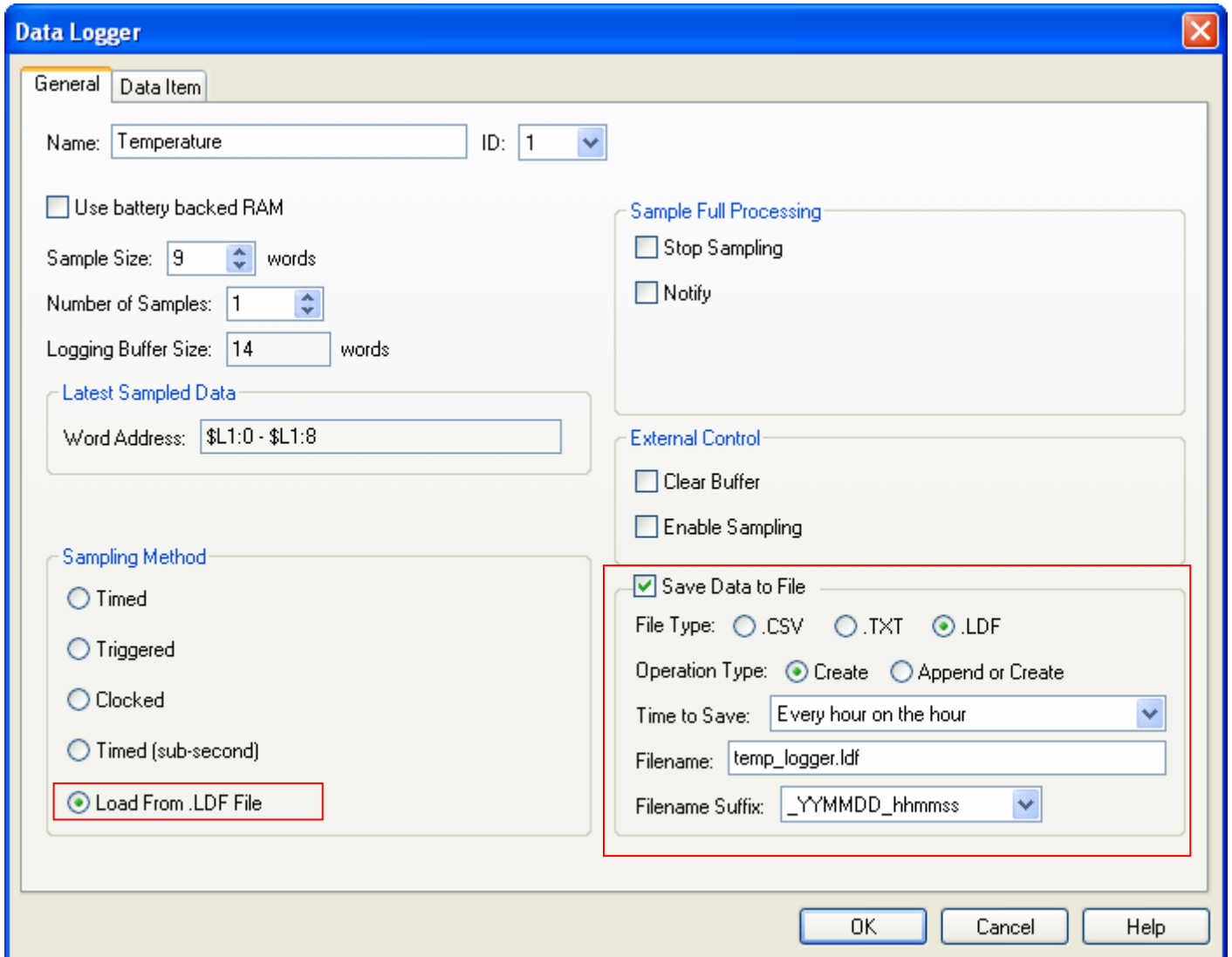

12.2. Displaying Logged Data Values Using Historic Data Tables

12.2.1. Basic Operations

Use the following steps to create a historic data table:

- 1) Click the Historic Data Table icon in the Object toolbar, or select Historic Data Table in the Object sub-menu.
- 2) Move the cursor to the screen on which you want to create the object.
- 3) Click the desired position on the screen to place the new object.

You can use a historic data table to list the values of the data collected by a data logger.

Date	Time	T1	T2	T3	P1	P2	P3	V1	V2	V3
05/03/09	08:51:39	344.9	379.4	69.0	215.8	163.2	152.7	126.4	115.8	100.0
05/03/09	08:51:34	931.3	1000.3	931.3	236.9	221.1	200.0	184.2	163.2	173.7
05/03/09	08:51:29	931.3	1000.3	1414.2	336.9	310.5	284.2	284.2	289.5	305.3
05/03/09	08:51:24	1655.6	1931.6	1517.7	352.6	336.9	315.8	321.1	321.1	315.8
05/03/09	08:51:19	1414.2	1655.6	1241.7	321.1	247.4	242.1	231.6	231.6	242.1
05/03/09	08:51:14	1241.7	1241.7	1034.8	268.4	247.4	221.1	200.0	194.8	179.0
05/03/09	08:51:09	896.8	931.3	896.8	247.4	215.8	200.0	179.0	168.5	179.0
05/03/09	08:51:04	655.3	724.3	758.8	210.6	210.6	179.0	184.2	173.7	173.7

The above is an example of the historic data table. The first row is the title row. It displays the title of each column. The other rows display one data record per row. You can create scroll button groups or scroll bars to scroll the contents. The titles of data columns are the names of data items defined in the Data Item page of the Data Logger dialog box.

12.2.2. Operation Options

The following operation option can be added to a historic data table. Select and set the option in the Historic Data Table dialog box.

Options	Description
Visibility Control	You can show and hide a historic data table by a specified bit or the current user level. Select and set this option in the Visibility page.

12.2.3. Settings

You can set up a historic data table with the Historic Data Table dialog box. There are three ways to open the dialog box of an object:

- 1) Double-click the object.
- 2) Right-click the object to bring up the Object pop-up menu. Select Properties in the pop-up menu.
- 3) In the Object List window, double-click the row that shows the information of the object.

You can complete all the settings of a historic data table in the Historic Data Table dialog box. This dialog box contains the following three pages.

- **General**

Described in [Section 12.2.4.](#)

- **Data Item**

Described in [Section 12.2.5.](#)

- **Visibility**

Described in [Section 4.4.6.](#)

12.2.4. General Settings

This section describes how to define the general settings for a historic data table. The following is an example of the General page.

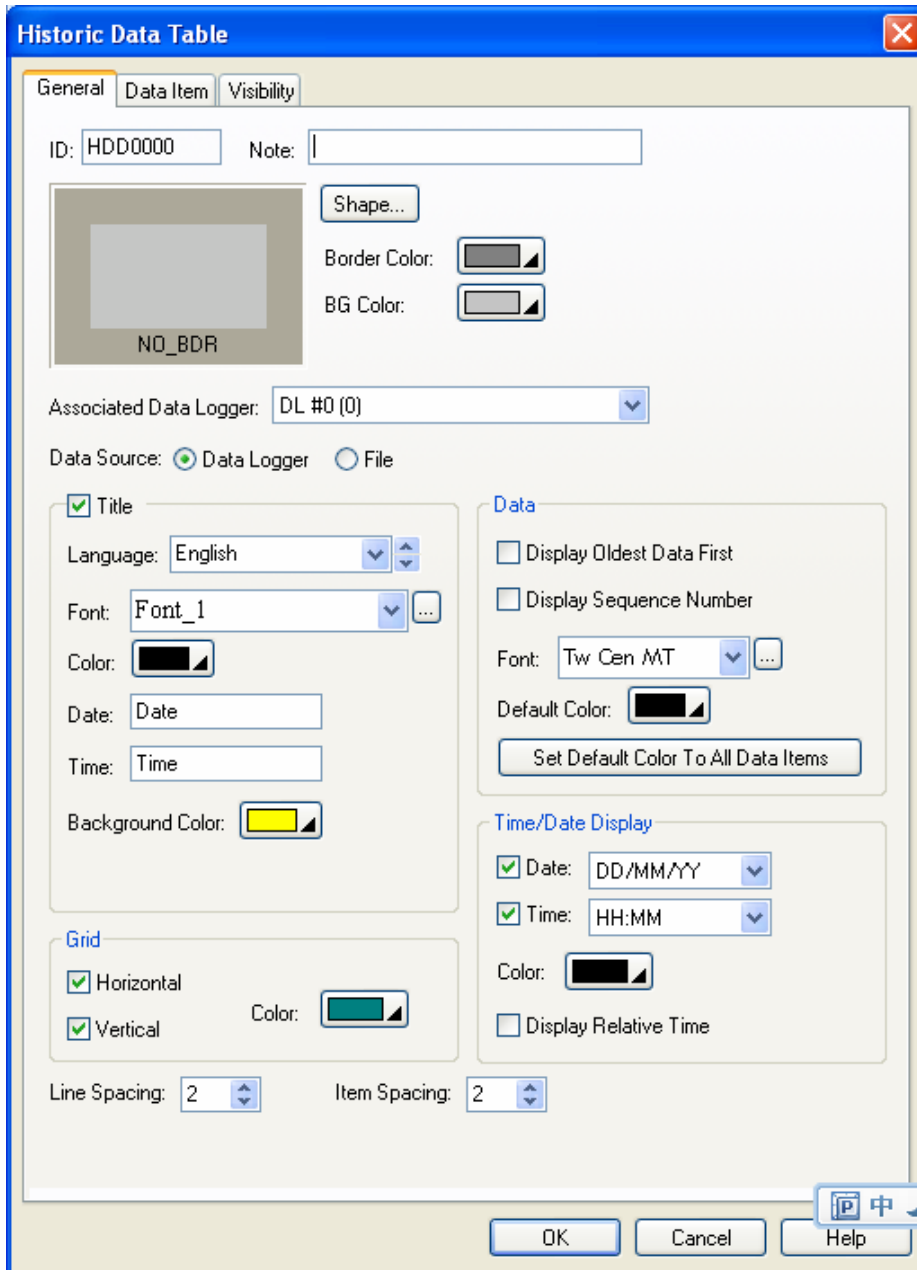

The following table describes each property in the General page.

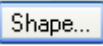
Property	Description
ID	The object's identifier. It is generated when the object is created and is unchangeable. The identifier is unique within the screen where the object is located. The format of the IDs for the historic data tables is HDDnnnn.
Note	You can type a note for the object.
Shape settings	For details about the following properties, Section 4.3.4 Setting up the Shape of an Object.  , Border Color, BG Color
Associated Data Logger	Select the data logger whose collected data is to be displayed by the object.

Continued

Property		Description
Data Source		<p>Select data logger or file as the source of the collected data.</p> <p>This new feature allows you to display historic data that are stored in files.</p> <p>There are two data sources you can select for Historic Trend Graphs, Historic Data Tables, and Single Record Line Charts.</p> <p>When "Data Logger" is selected as the data source for such objects, that object displays the sampled data stored in the logging buffer of the associated data logger.</p> <p>When "File" is selected as the data source for such objects, that object displays the sampled data stored in the specified file buffer.</p> <p>One HMI can have up to 16 file buffers and each file buffer is identified by a unique number between 0 and 15.</p> <p>You can create a function button to load the sampled data stored in a file.</p> <ol style="list-style-type: none"> 1) Select "Load Logged Data From File" as the operation of that function button. 2) Select the file extension type. Both CSV and TXT are supported. 3) Specify the associated data logger. 4) Specify the file buffer to save the loaded data. 5) Specify the size of the file buffer. The size is the maximum number of samples that the file buffer can hold.
File Buffer ID		Specify the File Buffer ID if the data source is a file. To specify a file buffer ID for a file, you can use the Load Logged Data From File operation of the function button. Please see Section 5.4 Performing Built-in Function Using Function Buttons for details.
Title	Title	Select this option if you want the object to display a title row.
	Language	Select a language so you can view and edit the settings of the title row for that language.
	Font	Select a font for the title text.
	Color	Select a color for the title text.
	Date	Specifies the title for the Date column.
	Time	Specifies the title for the Time column.
	Background Color	Select a color for the background of the title row.
Grid	Vertical	Check this option if you want the object to have vertical grids.
	Horizontal	Check this option if you want the object to have horizontal grids.
	Color	Select a color for the grids.
Data	Display oldest Data First	Check this option if you want the object to display the oldest data first.
	Display Sequence Number	Check this option if you want the object to display sequence number on the first column.
	Font	Select a font for displaying data.
	Default Color	Select a color as the default color for displaying data.
	Set Default Color to All Data Items	Click this button to set the colors of all the data items to the Default Color.
Time/Date Display	Date	Check this option if you want the object to display the Date column. You need to select a format for displaying the date.
	Time	Check this option if you want the object to display the Time column. You need to select a format for displaying the time.
	Color	Select a color to displaying Time/Date.
	Display Relative Time	Check this option if you want the object to display a relative measure of time.
Line Spacing		Specifies the extra space in pixels for two adjacent rows in the table.
Item Spacing		Specifies the extra space for every column in the table.

12.2.5. Data Item Settings

This section describes how to define the display format for the sampled values of each data item. The following is an example of the Data Item page.

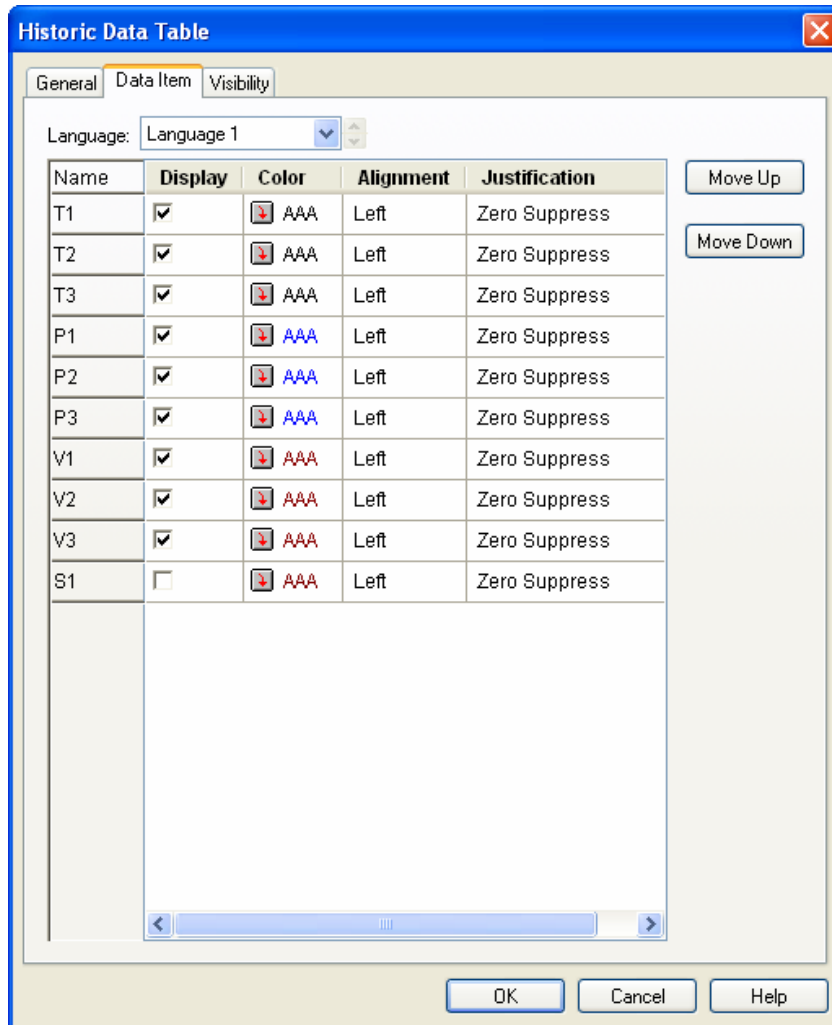

The following table describes each property in the Data Item page.

Property		Description							
Language		Select a language so you can view and edit the settings for that language.							
Row #n of the property table	Name	The name of data item #n. The data item names are defined in the Data Item page of the Data Logger dialog box.							
	Display	Check this option if you want the object to display data item #n.							
	Color	Select a color for displaying data item #n.							
	Alignment	The alignment for displaying data item #n. There are three types of alignment: Left, Center, and Right.							
	Justification	The justification for displaying data item #n. There are three types of justification: <table border="1" style="width: 100%; margin-top: 5px;"> <thead> <tr> <th>Option</th> <th>Description</th> </tr> </thead> <tbody> <tr> <td>Zero Suppress</td> <td>The leading digits will not display when they are 0.</td> </tr> <tr> <td>Leading Zeros</td> <td>All digits will display.</td> </tr> <tr> <td>Leading Spaces</td> <td>The leading digits will display as blank characters when they are 0.</td> </tr> </tbody> </table>	Option	Description	Zero Suppress	The leading digits will not display when they are 0.	Leading Zeros	All digits will display.	Leading Spaces
Option	Description								
Zero Suppress	The leading digits will not display when they are 0.								
Leading Zeros	All digits will display.								
Leading Spaces	The leading digits will display as blank characters when they are 0.								

12.3. Displaying Logged Data Trend Using Historic Trend Graph

12.3.1. Basic Operations

Follow the steps below to create a historic trend graph:

- 1) Click the Historic Trend Graph icon in the Object toolbar, or select Historic Trend Graph in the Object sub-menu.
- 2) Move the cursor to the screen on which you want to create the object.
- 3) Click the desired position on the screen to place the new object.

You can use a Historic Trend Graph to display the values of the data collected by a data logger as a trend graph.

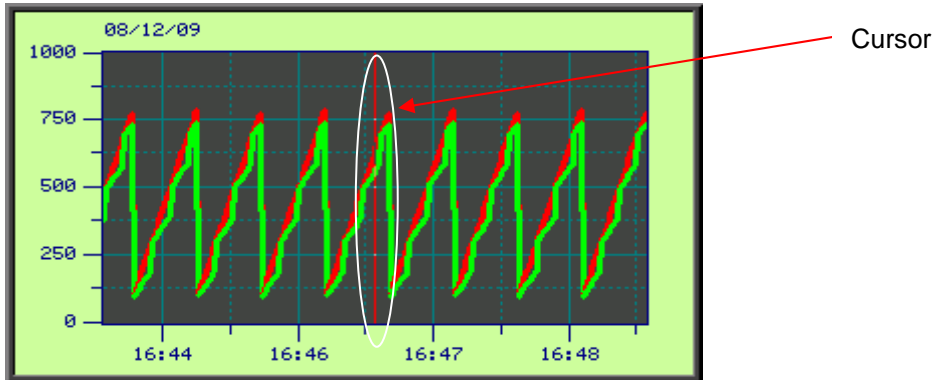

A historic trend graph can display up to 16 curves. The above is an example of the historic trend graph with two curves. A historic trend graph can provide a cursor for you to estimate the value in the desired time

12.3.2. Operation Options

The following operation option can be added to a historic trend graph. Select and set the option in the Historic Trend Graph dialog box.

Options	Description
Visibility Control	You can show and hide a historic trend graph by a specified bit or the current user level. Select and set this option in the Visibility page.

12.3.3. Settings

You can set up a historic trend graph with the Historic Trend Graph dialog box. There are three ways to open the dialog box of an object:

- 1) Double-click the object.
- 2) Right-click the object to bring up the Object pop-up menu. Select Properties in the pop-up menu.
- 3) In the Object List window, double-click the row that shows the information of the object.

The Historic Trend Graph dialog box contains the following four pages:

- **General**
Described in [Section 12.3.4.](#)
- **Curve**
Described in [Section 12.3.5.](#)
- **Axis**
Described in [Section 12.3.6.](#)
- **Visibility**
Described in [Section 4.4.6.](#)

12.3.4. General Settings



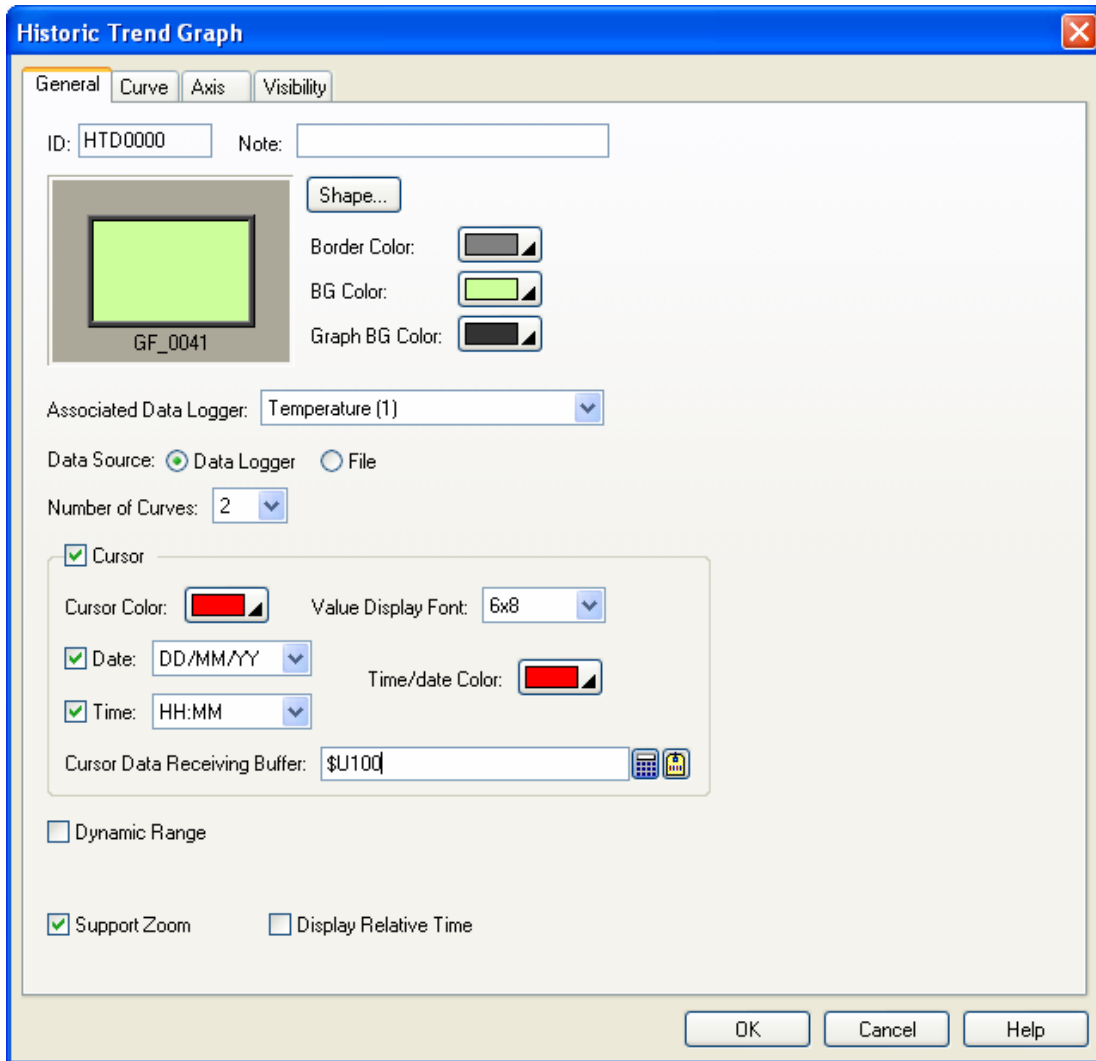

This section describes how to define the general settings for a historic trend graph. The following is an example of the General page of the Historic Trend Graph property sheet.

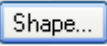

The following table describes each property in the General page.

Property	Description
ID	The object's identifier. It is generated when the object is created and is unchangeable. The identifier is unique within the screen where the object is located. The format of the IDs for the historic trend graph is HTDnnnn.
Note	You can type a note for the object.
Shape settings	For details about the following properties, see Section 4.3.4 Setting up the Shape of an Object .  , Border Color, BG Color.
Graph BG color	Select a color for the background of the graph.
Associated Data Logger	Specifies the associated data logger.
Data Source	Select data logger or file as the source of the collected data.
File Buffer ID	Specify the File Buffer ID if the data source is a file. To specify a file buffer ID for a file, you can use Load Logged Data From File operation of the function button. Please see Section 5.4 Performing Built-in Function Using Function Buttons for details.

Continued

Property		Description																									
Number of Curves		Specifies the number of curves.																									
Cursor	<Check box>	Check this option so the historic trend graph will display a cursor. You can touch and drag the cursor to the data point(s) that you want to select.																									
	Cursor Color	Select a color for the cursor.																									
	Value Display Font	Select a font for displaying the values of the selected data point(s).																									
	Date	Check this option to display the date at the top left of the historic trend graph object. You need to select a format for displaying the date. There are 12 formats available: dd/mm/yy, mm/dd/yy, yy/mm/dd, dd.mm.yy, mm.dd.yy, yy.mm.dd, dd-mm-yy, mm-dd-yy, yy-mm-dd, dd-MMM-yy, MMM-dd-yy, and yy-MMM-dd. Note: dd: 01-31 (day); mm: 01-12 (month); yy: 00-99 (year); MMM: JAN-DEC (month)																									
	Time	Check this option if you want the object to display the Time at the top left corner. You need to select a format for displaying the time.																									
	Time/Date Color	Select a color to display the Time/Date.																									
	Cursor Data Receiving Buffer	Specifies the variable to receive the data selected by the cursor to be read and displayed. Click  to enter an address for this field. Click  to select a tag for this field.																									
Dynamic Range	Dynamic Range	When this option is selected, the following three ranges can be specified at runtime: <ul style="list-style-type: none"> • The minimum and the maximum for the Y values of each curve • The maximum time duration for the X axis • The minimum and maximum of the marks for the Y axis The data that specifies the above three ranges should be set and arranged correctly in a memory block called the dynamic range parameter block. You need to specify the dynamic range parameter block in the Dynamic Range Parameter Block field.																									
	Dynamic Range Parameter Block	Specifies the variable that stores the dynamic range parameter block for the historic trend graph when Dynamic Range is selected. Click  to enter an address for this field. Click  to select a tag for this field. The following table shows the data arrangement of the parameter block. <table border="1" data-bbox="454 1317 1497 1933"> <thead> <tr> <th>Word</th> <th>Description</th> </tr> </thead> <tbody> <tr> <td>0,1</td> <td>The maximum time duration for the time axis (X axis)</td> </tr> <tr> <td>2,3</td> <td>The number of major division for the time axis (X axis); 32-bit integer number. The minimum value is 1.</td> </tr> <tr> <td>4,5</td> <td>The number of sub-division for the time axis (X axis); 32-bit integer number. The minimum value is 1.</td> </tr> <tr> <td>6,7</td> <td>The minimum of the mark for the Y axis</td> </tr> <tr> <td>8,9</td> <td>The maximum of the mark for the Y axis</td> </tr> <tr> <td>10,11</td> <td>The minimum of Y values for curve #1</td> </tr> <tr> <td>12,13</td> <td>The maximum of Y values for curve #1</td> </tr> <tr> <td>14,15</td> <td>The minimum of Y values for curve #2</td> </tr> <tr> <td>16,17</td> <td>The maximum of Y values for curve #2</td> </tr> <tr> <td>...</td> <td>...</td> </tr> <tr> <td>70,71</td> <td>The minimum of Y values for curve #16</td> </tr> <tr> <td>72,73</td> <td>The maximum of Y values for curve #16</td> </tr> </tbody> </table>	Word	Description	0,1	The maximum time duration for the time axis (X axis)	2,3	The number of major division for the time axis (X axis); 32-bit integer number. The minimum value is 1.	4,5	The number of sub-division for the time axis (X axis); 32-bit integer number. The minimum value is 1.	6,7	The minimum of the mark for the Y axis	8,9	The maximum of the mark for the Y axis	10,11	The minimum of Y values for curve #1	12,13	The maximum of Y values for curve #1	14,15	The minimum of Y values for curve #2	16,17	The maximum of Y values for curve #2	70,71	The minimum of Y values for curve #16	72,73
Word	Description																										
0,1	The maximum time duration for the time axis (X axis)																										
2,3	The number of major division for the time axis (X axis); 32-bit integer number. The minimum value is 1.																										
4,5	The number of sub-division for the time axis (X axis); 32-bit integer number. The minimum value is 1.																										
6,7	The minimum of the mark for the Y axis																										
8,9	The maximum of the mark for the Y axis																										
10,11	The minimum of Y values for curve #1																										
12,13	The maximum of Y values for curve #1																										
14,15	The minimum of Y values for curve #2																										
16,17	The maximum of Y values for curve #2																										
...	...																										
70,71	The minimum of Y values for curve #16																										
72,73	The maximum of Y values for curve #16																										

Continued

Property	Description
Support Zoom	Check this option so the zoom option will be supported at runtime. You may use the function button to zoom in or zoom out of the historic trend graph at the runtime. This field is available only when the Dynamic Range field is not checked.
Display Relative Time	Check this option if you want the object to display a relative measure of time.

12.3.5. Curve Settings

This section describes how to define the pens of the historic trend graph. The following is an example of the Pen page.

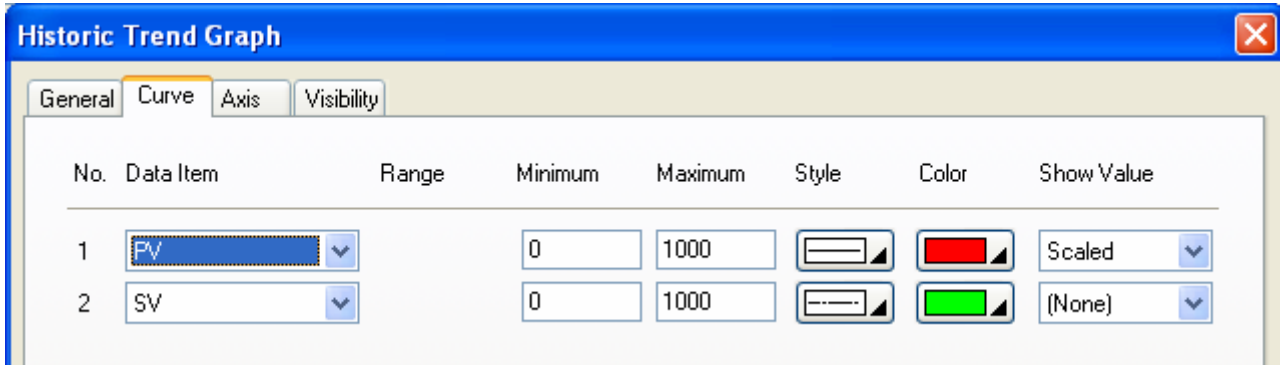

The following table describes each property on the Curve page.

Property	Description								
Data Item	Select a data item in the associated data logger for the curve.								
Range	Check this option so the minimum and the maximum for the Y values of the associated curve will be specified at runtime. This option is available only when the Dynamic Range option on the General page is checked.								
Minimum	The Y minimum of the data value of the associated curve. This property is available when the Dynamic Range option is not selected.								
Maximum	The Y maximum of the data value of the associated curve. This property is available when the Dynamic Range option is not selected.								
Style	Select a style for the trend curve.								
Color	Select a color for the trend curve.								
Show Value	Select one of the following methods for displaying the selected data point value. <table border="1" data-bbox="279 1496 1481 1668"> <thead> <tr> <th>Show Value</th> <th>Description</th> </tr> </thead> <tbody> <tr> <td>(None)</td> <td>Does not display the data point value.</td> </tr> <tr> <td>Original</td> <td>Displays the data point value without modification.</td> </tr> <tr> <td>Scaled</td> <td>Displays the corresponding Y axis value of the data point.</td> </tr> </tbody> </table>	Show Value	Description	(None)	Does not display the data point value.	Original	Displays the data point value without modification.	Scaled	Displays the corresponding Y axis value of the data point.
Show Value	Description								
(None)	Does not display the data point value.								
Original	Displays the data point value without modification.								
Scaled	Displays the corresponding Y axis value of the data point.								

12.3.6. Axis Settings

This section describes how to define the Time axis (X axis) and the Y axis for the historic trend graph.

The following table describes each property in the Axis page.

Property		Description
Time Axis (X Axis) – Time Range	Dynamic Range	Check this option if you want the maximum time duration to be controlled by the dynamic range parameter block of the associated object at runtime. This option is available only when the Dynamic Range option on the General page is checked.
	Unit	Select a unit for the dynamic range. The field is only available when Dynamic Range is checked.
	Day/Hour/Minute/Second	If Dynamic Range is not checked on both the general page and the axis page, you need to specify the maximum time duration.

Continued

Property		Description						
Time Axis (X Axis)	Number of Major Divisions	The number of major divisions for the X axis. The minimum you can specify is one.						
	Number of Sub-divisions	The number of divisions between two adjacent major ticks. The minimum you can specify is one.						
	Show Ticks	Check this option if you want the X axis to have ticks.						
	Show Y-axis Grid	Select this option if you want the X axis to have vertical grids.						
	Grid Color	Select a color for the vertical grids.						
	Show Time	Check this option if you want to display the time. You need to select a format for displaying the time.						
	Time Format	The format of how the time is displayed. There are two formats available. <table border="1" data-bbox="555 622 1481 752"> <thead> <tr> <th>Format</th> <th>Description</th> </tr> </thead> <tbody> <tr> <td>HH:MM</td> <td>HH: 00-23 (hour); MM: 00-59 (minute)</td> </tr> <tr> <td>HH:MM:SS</td> <td>HH: 00-23 (hour); MM: 00-59 (minute); SS: 00-59 (second)</td> </tr> </tbody> </table>	Format	Description	HH:MM	HH: 00-23 (hour); MM: 00-59 (minute)	HH:MM:SS	HH: 00-23 (hour); MM: 00-59 (minute); SS: 00-59 (second)
	Format	Description						
	HH:MM	HH: 00-23 (hour); MM: 00-59 (minute)						
	HH:MM:SS	HH: 00-23 (hour); MM: 00-59 (minute); SS: 00-59 (second)						
Time/Date Font	Font of the time/date.							
Time/Date/Tick Color	Select a color for the X axis and its ticks.							
Y Axis	Number of Major Divisions	The number of major divisions for the Y axis. The minimum you can specify is one.						
	Number of Sub-divisions	The number of divisions between two adjacent major ticks. The minimum you can specify is one.						
	Show Ticks	Check this option if you want the Y axis to have ticks.						
	Show X-axis Grid	Select this option if you want the Y axis to have horizontal grids.						
	Grid Color	Select a color for the horizontal grids.						
Y Axis Mark	Show Marks	Check this option if you want the major ticks to have marks.						
	Font	The font of the marks.						
	Dynamic Range	Check this option if you want the minimum and maximum of the marks to be controlled by the dynamic range parameter block of the associated object at runtime.						
	Minimum	The minimum of the marks. You can specify a 32-bit signed integer.						
	Maximum	The maximum of the marks. You can specify a 32-bit signed integer.						
	Total Digits	The total digits to be displayed for the marks.						
	Fractional Digits	The number of fractional digits for the marks. For example, when the Maximum is 5000, the Total Digits is 4, and the Fractional Digits is 2, the mark for the Maximum will be 50.00.						
	Position	Select a position to locate the scale. The scale can be displayed on the left, the right or both sides.						
Mark/Tick Color	Select a color for the marks and ticks.							

12.4. Displaying History of Predefined Events Using Historic Event Tables

12.4.1. Basic Operations

Follow the steps below to create a historic event table:

- 1) Click Historic Event Table icon in the Object toolbar, or select Historic Event Table in the Object sub-menu.
- 2) Move the cursor to the screen on which you want to create the object.
- 3) Click at the desired position on the screen to place the new object.

You can number the predefined events of your application, use a word in the controller or the target panel to store the number of the current event at runtime, and have a data logger in the target panel to collect the value of that word. This is a way to record the events of your application. You can use the historic event table to display the event history. Each message defined for the historic event table is associated with an event by the message/event number.

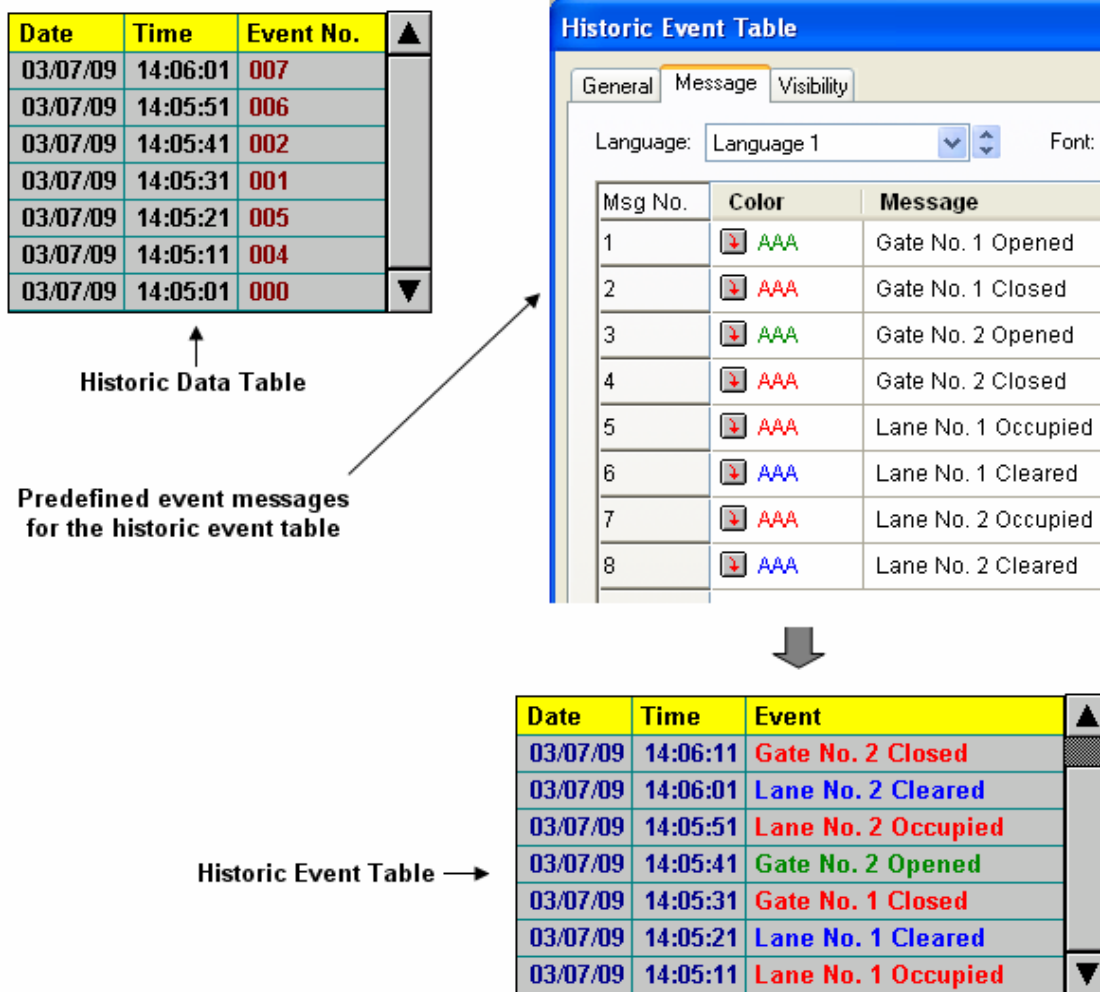

In the above example, the historic data table and the historic event table display the same historic data in different ways.

12.4.2. Operation Options

The following operation option can be added to a historic event table. Select and set the option in the Historic Event Table dialog box.

Options	Description
Visibility Control	You can show and hide a historic event table by a specified bit or the current user level. Select and set this option in the Visibility page.

12.4.3. Settings

You can set up a historic event table with the Historic Event Table dialog box. There are three ways to open the dialog box of an object:

- 1) Double-click the object.
- 2) Right-click the object to bring up the Object pop-up menu. Select Properties in the pop-up menu.
- 3) In the Object List window, double-click the row that displays the information of the object.

You can complete all the settings of a historic event table in the Historic Event Table dialog box. This dialog box contains the following three pages.

- **General**

Described in [Section 12.4.4.](#)

- **Message**

Described in [Section 12.4.5.](#)

- **Visibility**

Described in [Section 4.4.6.](#)

12.4.4. General Settings

This section describes how to define the general settings for a historic event table. The following is an example of the General page.

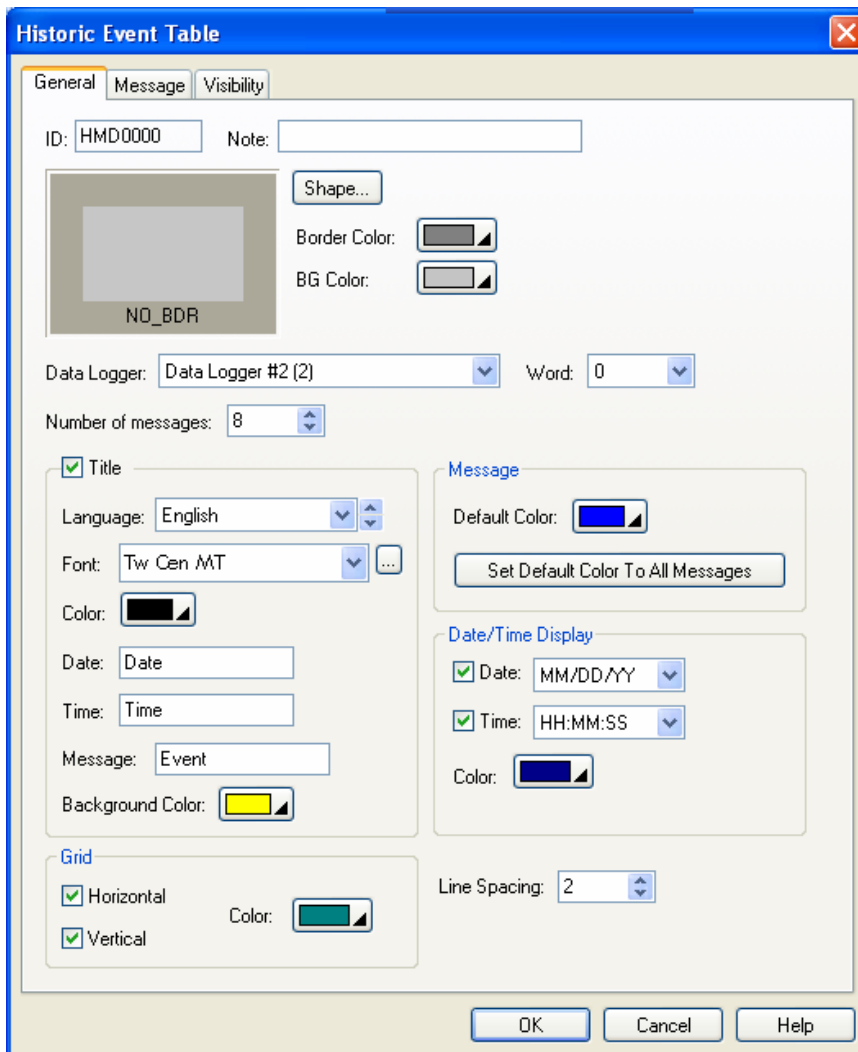

The following table describes each property in the General page.

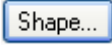
Property	Description
ID	The object's identifier. It is generated when the object is created and is unchangeable. The identifier is unique within the screen where the object is located. The format of the IDs for the historic event tables is HMDnnnn.
Note	You can type a note for the object.
Shape settings	For details about the following properties, see Section 4.3.4 Setting up the Shape of an Object .  , Border Color, BG Color
Data Logger	Specifies the associated data logger. The object will take a specified word in each of the data records collected by the data logger as the event number, and display a corresponding message for that number.
Word	Specifies the number of the word in each of the data records that stores the event number.
Number of messages	Specifies the number of event messages.

Continued

Property		Description
Title	Title	Select this option if you want to have a title row.
	Language	Select a language so you can view and edit the settings of the title row for that language.
	Font	Select a font for the title text.
	Color	Select a color for the text.
	Date	Specifies the title of the Date column.
	Time	Specifies the title of the Time column.
	Message	Specifies the title of the Message column.
	Background Color	Select a color for the background of the title row.
Grid	Vertical	Check this option if you want the object to display vertical grids.
	Horizontal	Check this option if you want the object to display horizontal grids.
	Color	Select a color for the grids.
Message	Font	Select a font for displaying messages.
	Default Color	Select a color as the default message color.
	Set Default Color To All Messages	Click this button to set the colors of all the messages to the Default Color.
Date/Time Display	Date	Check this option if you want the object to display the Date column. You need to select a format for displaying the date.
	Time	Check this option if you want the object to display the Time column. You need to select a format for displaying the time.
Line Spacing		Specifies the extra space in pixels for two adjacent rows in the table.

12.4.5. Message Settings

This section describes how to define the messages of the historic event table. The following is an example of the Message page.

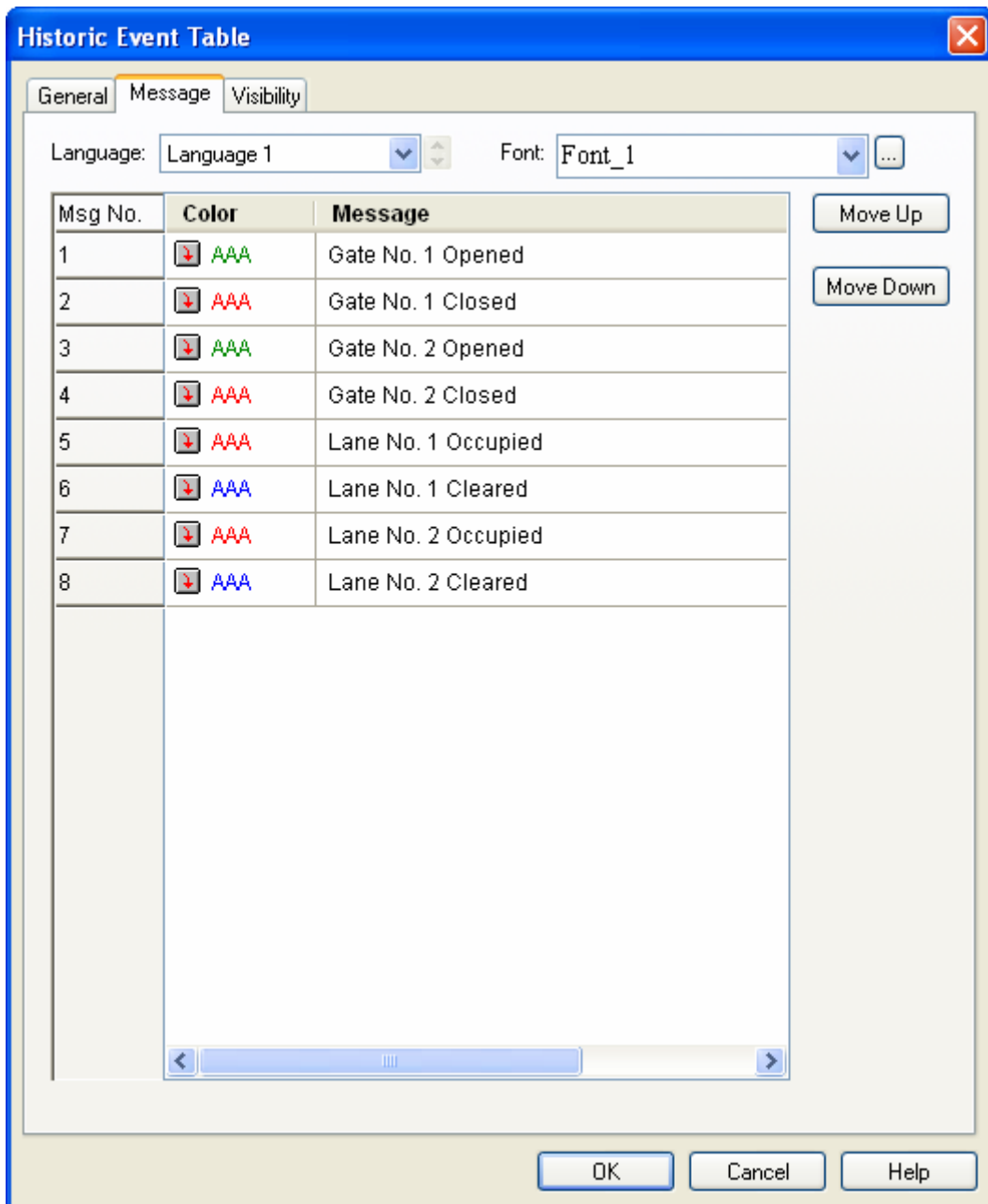

The following table describes each property in the Message page.

Property		Description
Language		Select a language so you can view and edit the settings for that language.
Font		Select a font for displaying the messages.
No. 1-N	Color	Select a color for displaying the message of the associated event.
	Message	Define the text message for the associated event.

12.5. Displaying Time Slice Data Profile Using Single Record Line Charts

12.5.1. Basic Operations

Use the following steps to create a single record line chart:

- 1) Click the Single Record Line Chart icon in the Object toolbar, or select Single Record Line Chart in the Object sub-menu.
- 2) Move the cursor to the screen on which you want to create the object.
- 3) Click at the desired position on the screen to place the new object.

You can use a single record line chart to display the values of the data collected by a data logger as a line chart.

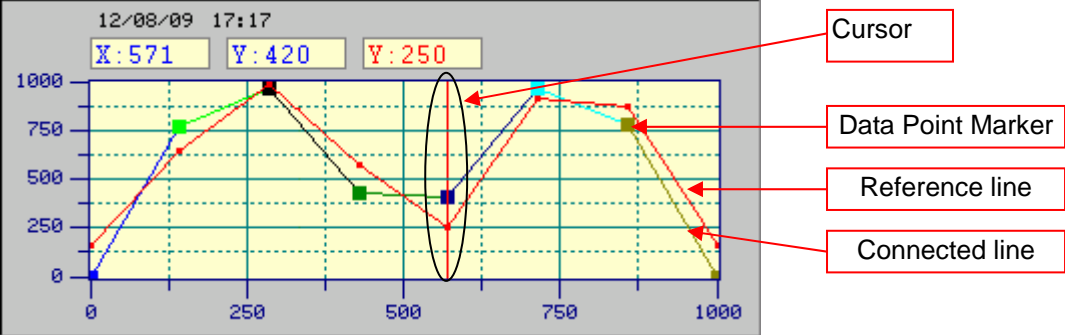

A single record line chart can display up to 255 data points. The above is an example of the single record line chart with 8 data points. A single record line chart can provide a cursor to display the value of the desired point.

12.5.2. Operation Options

The following operation option can be added to a historic trend graph. Select and set the option in the Historic Trend Graph dialog box.

Options	Description
Visibility Control	You can show and hide a historic trend graph by a specified bit or the current user level. Select and set this option in the Visibility page.

12.5.3. Settings

You can set up a single record line chart with the Single Record Line Chart dialog box. There are three ways to open the dialog box of an object:

- 1) Double-click the object.
- 2) Right-click the object to bring up the Object pop-up menu. Select Properties in the pop-up menu.
- 3) In the Object List window, double-click the row that displays the information of the object.

The Single Record Line Chart dialog box contains the following four pages:

- **General**

Described in [Section 12.5.4.](#)

- **Pen**

Described in [Section 12.5.5.](#)

- **Axis**

Described in [Section 12.5.6.](#)

- **Visibility**

Described in [Section 4.3.6.](#)



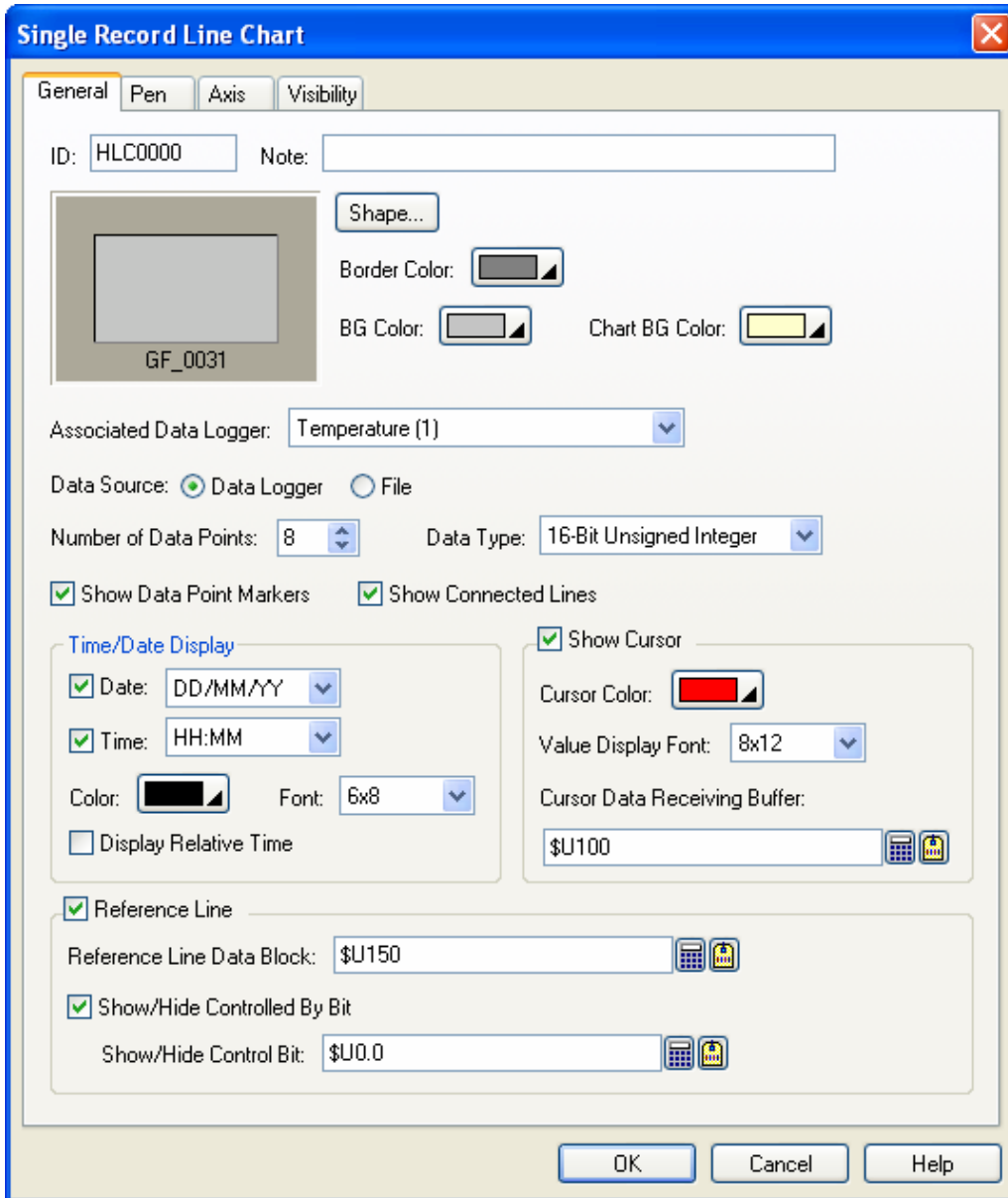



12.5.4. General Settings



The following table describes each property in the General page.

Property	Description
ID	The object's identifier. It is generated when the object is created and is unchangeable. The identifier is unique within the screen where the object is located. The format of the IDs for the Single Record Line Charts is HLCnnnn.
Note	You can type a note for the object.
Shape settings	For details about the following properties, see Section 4.3.4 Setting up the Shape of an Object . Shape... , Border Color, BG Color
Associated Data Logger	Specifies the associated data logger.
Data Source	Select a data logger or file as the source of the collected data.
File Buffer ID	Specify the File Buffer ID if the data source is a file. To specify a file buffer ID for a file, you can use the Load Logged Data From File operation of the function button. Please see Section 5.4 Performing Built-in Function Using Function Buttons for details.

Continued

Property		Description
Number of Data Points		Specifies the number of data points.
Data Type		The data type of the data logger. The supported data types include: 16-Bit Unsigned Integer, 32-Bit Unsigned Integer, 16-Bit Signed Integer, 32-Bit Signed Integer, 16-Bit BCD, 32-Bit BCD, 32-Bit Floating Point, 16-Bit Signed BCD (LMB), 32-Bit Signed BCD (LMB), 16-Bit Signed BCD (LMD), and 32-Bit Signed BCD (LMD).
Show Data Point Markers		Check this option so the single record line chart will display all the data point markers.
Show Connected Lines		Check this option so the single record line chart will display the connected lines.
Time/Date Display	Date	Check this option if you want the object to display the Date column. You need to select a format for displaying the date.
	Time	Check this option if you want the object to display the Time column. You need to select a format for displaying the time.
	Color	Select a color for the text.
	Font	Select a font for the title text.
	Display Relative Time	Check this option if you want the object to display a relative measure of time.
Show Cursor	<Check Box>	Check this option so the single record line chart will display a cursor. You can touch and drag the cursor to the data point(s) that you want to select.
	Cursor Color	Select a color for the cursor.
	Value Display Font	Select a font for displaying the values of the selected data point(s).
	Cursor Data Receiving Buffer	Specifies the variable to receive the data selected by the cursor to be read and displayed. Click  to enter an address for this field. Click  to select a tag for this field.
Reference Line	<Check Box>	Check this option so the single record line chart will display a reference line.
	Reference Line Data Block	Specifies the variable as the data to be read from and displayed as a reference for comparison. Click  to enter the word address. Click  to enter the word tag.
	Show/Hide Controlled By Bit	Check this option if you want to show or hide the reference line controlled by the specified bit.
	Show/Hide Control Bit	Specifies the bit that controls the reference line to be shown or hidden. Click  to enter the bit address. Click  to enter the bit tag.

12.5.5. Pen Settings

This section describes how to define the pens for the line charts. The following is an example of the Pen page.

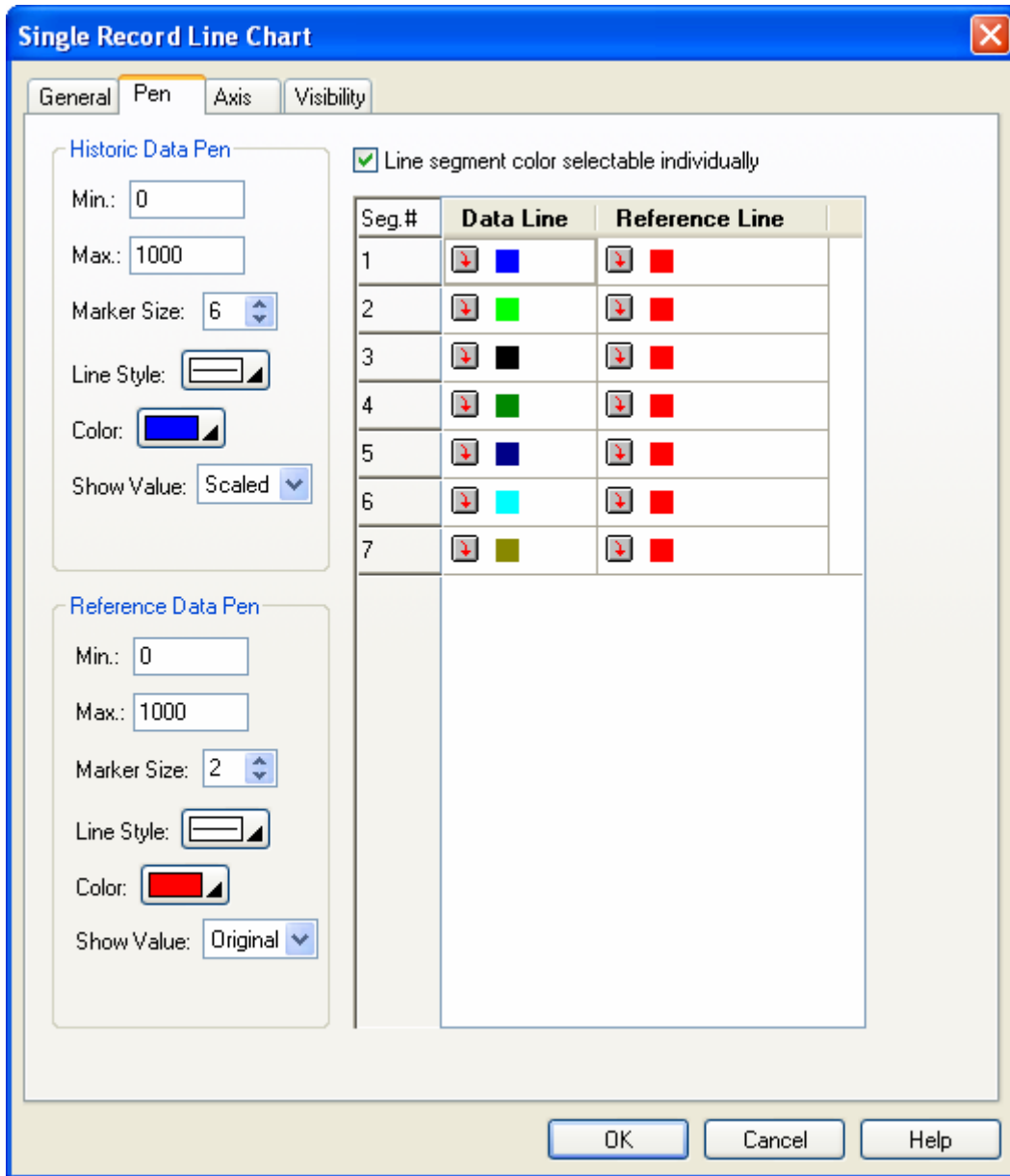

The following table describes each property in the Pen page.

Property		Description							
Historic Data Pen	Min.	The minimum of the associated data set. This property is available when the Dynamic Range option is not selected.							
	Max.	The maximum of the associated data set. This property is available when the Dynamic Range option is not selected.							
	Mark Size	Select a size for the data point mark. The selection is valid when the Show Mark option in the General page is selected.							
	Line Style	Select a style for the connecting lines. The selection is valid when the Show Line option in the General page is selected.							
	Color	Select a color for the connecting lines.							
	Show Value	Select one of the following methods for displaying the selected data point value. <table border="1" data-bbox="438 645 1505 815"> <thead> <tr> <th>Show Value</th> <th>Description</th> </tr> </thead> <tbody> <tr> <td>(None)</td> <td>Does not display the data point value.</td> </tr> <tr> <td>Original</td> <td>Displays the data point value without modification.</td> </tr> <tr> <td>Scaled</td> <td>Displays the corresponding Y axis value of the data point.</td> </tr> </tbody> </table> <p>The selection is valid when the Show Cursor option in the General page is selected.</p>	Show Value	Description	(None)	Does not display the data point value.	Original	Displays the data point value without modification.	Scaled
Show Value	Description								
(None)	Does not display the data point value.								
Original	Displays the data point value without modification.								
Scaled	Displays the corresponding Y axis value of the data point.								
Reference Data Pen	Min.	The minimum of the associated data set. This property is available when the Dynamic Range option is not selected.							
	Max.	The maximum of the associated data set. This property is available when the Dynamic Range option is not selected.							
	Mark Size	Select a size for the data point mark. The selection is valid when the Show Mark option in the General page is selected.							
	Line Style	Select a style for the connecting lines. The selection is valid when the Show Line option in the General page is selected.							
	Color	Select a color for the connecting lines.							
	Show Value	Select one of the following methods for displaying the selected data point value. <table border="1" data-bbox="438 1283 1505 1453"> <thead> <tr> <th>Show Value</th> <th>Description</th> </tr> </thead> <tbody> <tr> <td>(None)</td> <td>Does not display the data point value.</td> </tr> <tr> <td>Original</td> <td>Displays the data point value without modification.</td> </tr> <tr> <td>Scaled</td> <td>Displays the corresponding Y axis value of the data point.</td> </tr> </tbody> </table> <p>The selection is valid when the Show Cursor option in the General page is selected.</p>	Show Value	Description	(None)	Does not display the data point value.	Original	Displays the data point value without modification.	Scaled
Show Value	Description								
(None)	Does not display the data point value.								
Original	Displays the data point value without modification.								
Scaled	Displays the corresponding Y axis value of the data point.								
Line segment color selectable individually	Check this option to set the line segment color individually in the list window. The list window has three columns. The first column is the line segment number. The second column is the color setting for the data line. The third column is the color setting for the reference line.								

12.5.6. Axis Settings

This section describes how to define the X axis and the Y axis for single record line charts.

The following is an example of the Axis page.

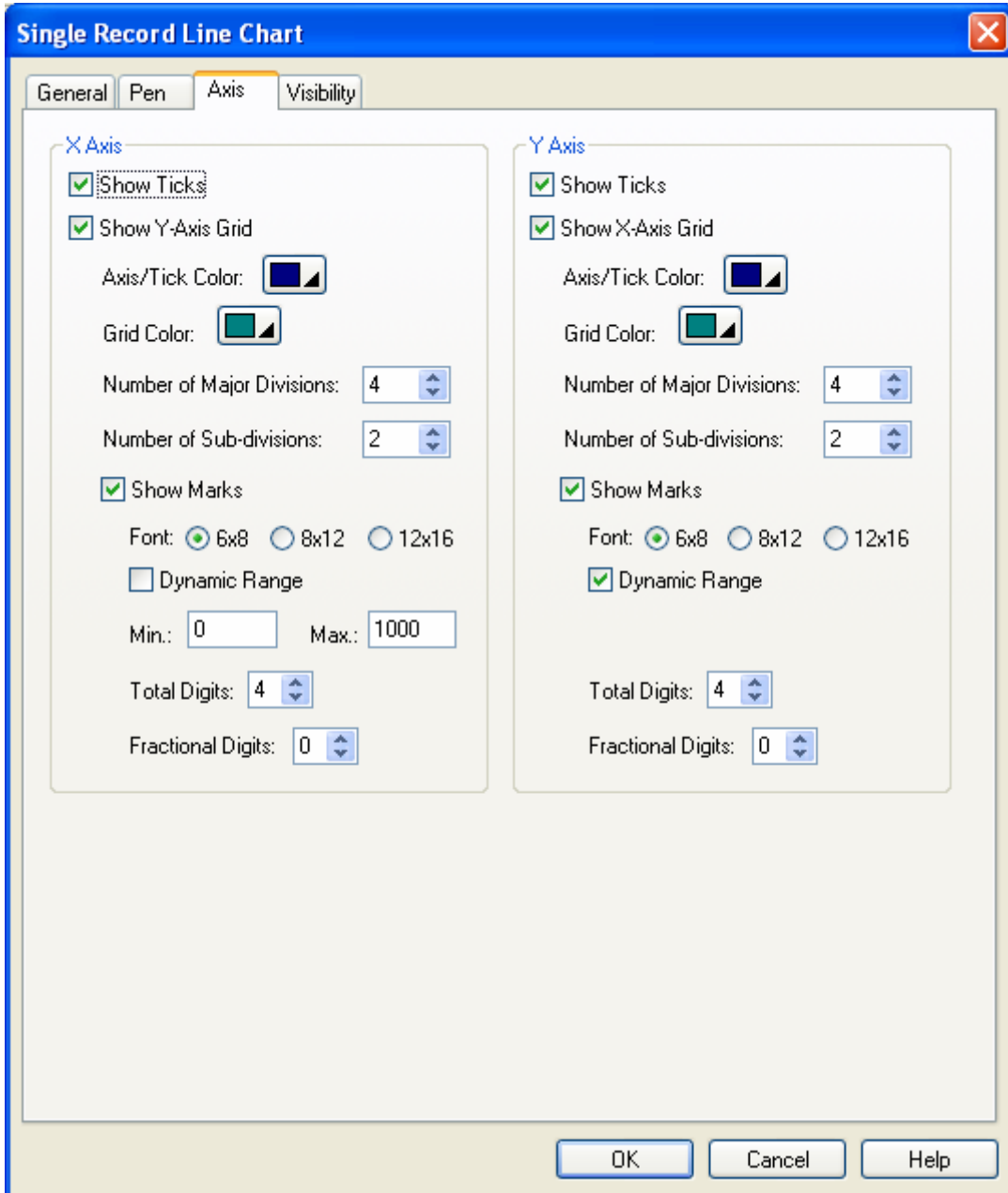

The following table describes each property in the Axis page.

Property		Description
X Axis	Show Ticks	Check this option if you want the X axis to have ticks.
	Show Y-axis Grid	Select this option if you want the X axis to have vertical grids.
	Axis/Tick Color	Select a color for the X axis and its ticks.
	Grid Color	Select a color for the vertical grids.
	Number of Major Divisions	The number of major divisions for the X axis. The minimum you can specify is one.
	Number of Sub-divisions	The number of divisions between two adjacent major ticks. The minimum you can specify is one.
Mark	Show Marks	Check this option if you want the major ticks to have marks.
	Font	The font of the marks.
	Dynamic Range	Check this option if you want the minimum and maximum of the marks to be controlled by the dynamic range parameter block of the associated object at runtime.
	Min.	The minimum of the marks. It is a 32-bit integer.
	Max.	The maximum of the marks. It is a 32-bit integer.
	Total Digits	The total digits to be displayed for the marks.
	Fractional Digits	The number of fractional digits for the marks. For example, when the Maximum is 5000, the Total Digits is 4, and the Fractional Digits is 2, the mark for the Maximum will be 50.00.
Y Axis	Show Ticks	Check this option if you want the Y axis to have ticks.
	Show X-axis Grid	Select this option if you want the Y axis to have horizontal grids.
	Axis/Tick Color	Select a color for the X axis and its ticks.
	Grid Color	Select a color for the horizontal grids.
	Number of Major Divisions	The number of major divisions for the Y axis. The minimum you can specify is one.
	Number of Sub-divisions	The number of divisions between two adjacent major ticks. The minimum you can specify is one.
Mark	Show Marks	Check this option if you want the major ticks to have marks.
	Font	The font of the marks.
	Dynamic Range	Check this option if you want the minimum and maximum of the marks to be controlled by the dynamic range parameter block of the associated object at runtime.
	Min.	The minimum of the marks. You can specify a 32-bit signed integer.
	Max.	The maximum of the marks. You can specify a 32-bit signed integer.
	Total Digits	The total digits to be displayed for the marks.
	Fractional Digits	The number of fractional digits for the marks. For example, when the Maximum is 5000, the Total Digits is 4, and the Fractional Digits is 2, the mark for the Maximum will be 50.00.

CHAPTER 13

OPERATION LOGGING

13.1. Using Operation Logging.....	1
13.2. Setting up Operation Logging.....	2
13.2.1. Operation Message.....	3
13.3. Setting up Operation Log Displays.....	4
13.3.1. Basic Operations.....	4
13.3.2. Operation Options.....	4
13.3.3. Settings.....	4
13.3.4. General Settings.....	5

This chapter describes how to set up operation logging and configure the operation log display to show the operation loggers.

13.1. Using Operation Logging

To use operation logging in your application, please do the following:

- 1. Setting up Operation Logging
Described in [Section 13.2](#)
- 2. Adding custom operation messages in the Advanced page of the related object
Described in [Section 4.4.5](#)

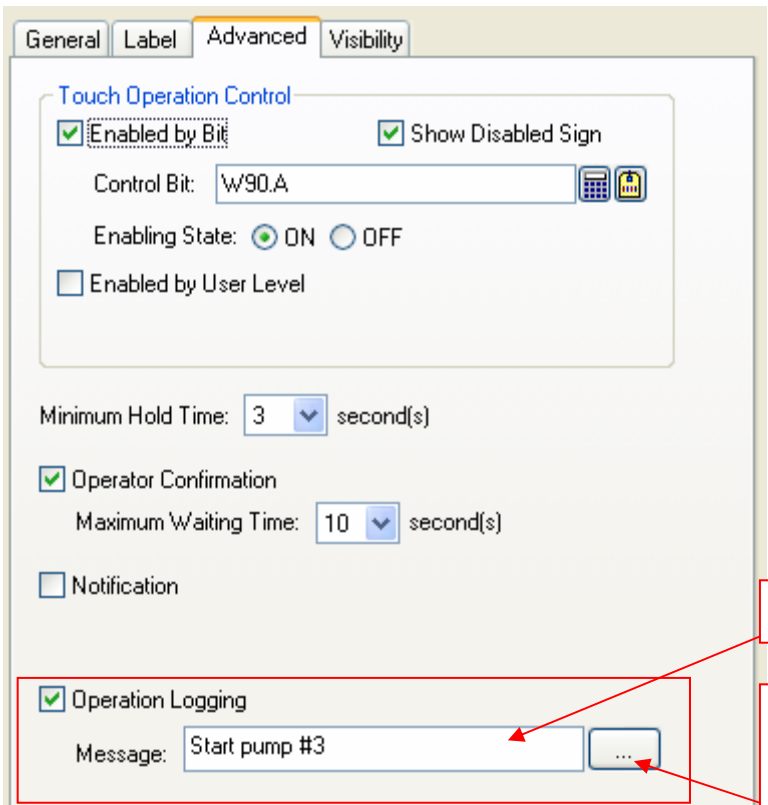

Enter the operation message of the first language.

Click the button to bring up the Operation Message dialog box to edit the message for all the languages. Please see details in [Section 13.2.1](#).

- 3. Creating and configuring Operation Log Displays
Described in [Section 13.3](#)

The software also lets users clear the operation logging buffer with the function button. To know how to define a function button to clear the operation history, please see [Section 5.4.1 Basic Operations](#) of function buttons.

13.2. Setting up Operation Logging

You can set up operation logging with the Operation Logging dialog box. In this dialog, you can determine the required memory for the operation logging buffer, and specify how to save the operation logs to a text file. To open the dialog box, double click the Operation Logging node in the Project Manager tool window, or use the Operation Logging... command on the Panel menu. The following is an example of the Operation logging dialog box.

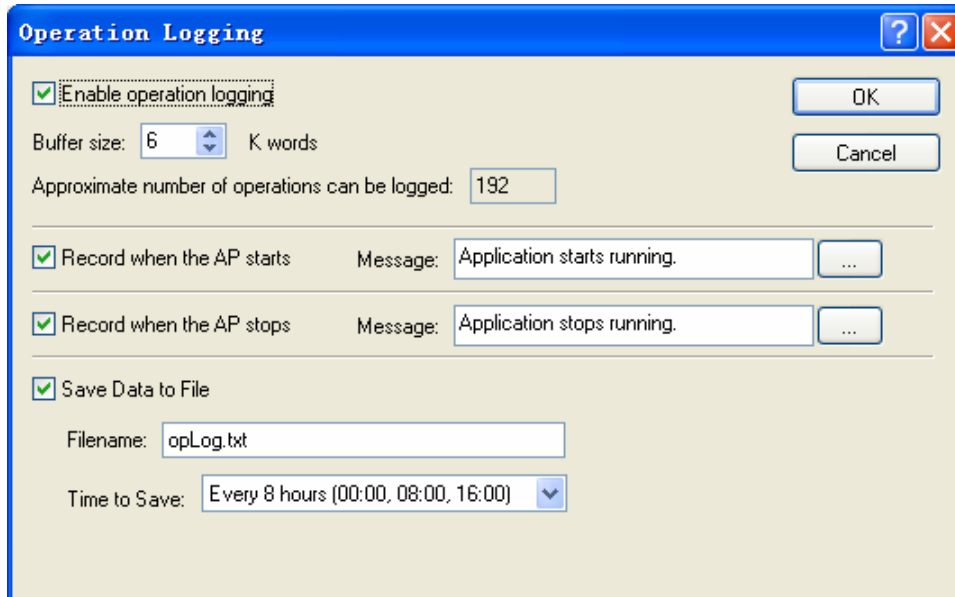

The table below describes each property in the Operation Logging Properties dialog.

Property		Description
Enable operation logging	<Check Box>	Check this option to enable operation logging.
	Buffer Size	The size of the operation logging buffer. The unit is K words. The buffer size can be specified between 1 and 512 K words.
	Approximate number of operations can be logged	The maximum number of operation loggers that the operation logging buffer can hold. The formula to calculate the approximate number is: $\text{Number} = \text{Buffer Size} * 1024 * 2 / 64$
Record when the AP starts	<Check Box>	Check this option to enable operation logging.
	Message	Enter the operation message of the first language when the AP starts.
	...	Click the button to bring up the Operation Message dialog box to edit the message for all the languages. Please see details in Section 13.2.1.
Record when the AP stops	<Check Box>	Check this option to enable operation logging.
	Message	Enter the operation message of the first language when the AP stops.
	...	Click the button to bring up the Operation Message dialog box to edit the message for all the languages. Please see details in Section 13.2.1.
Save Data to File	<Check Box>	Check this option so new operation loggers will be written to a specified file periodically. Each time when a save is performed, the panel writes only the operation loggers that have not been saved to a file before.
	File Name	The filename or the prefix of the filename of the file to save the operation loggers as. The operation loggers are saved in text format and the file extension name must be ".txt". You can use any text editor and Microsoft Excel to directly view the operation loggers. This item is available when the option Save Data to File is checked.
	Time to Save	Specifies the period to save the operation loggers. This item is available when the option Save Data to File is checked. There are nine periods available: Every hour on the hour ; Every 8 hours (00:00, 08:00, 16:00) ; Every 12 hours (00:00, 12:00) Every day at 00:00; Every day at 08:00; Every day at 12:00; Every Sunday at 00:00; Every Monday at 00:00; Every month's first day at 00:00.

13.2.1. Operation Message

This section describes how to define the operation messages for all languages. The following is an example of Operation Message dialog box.

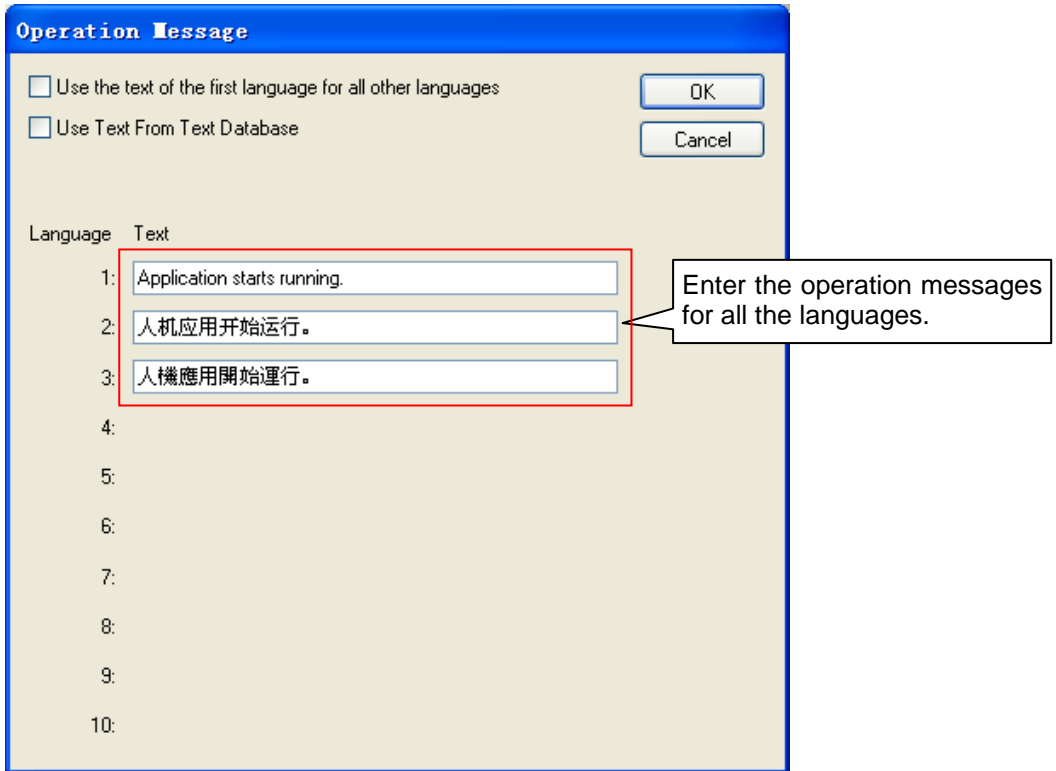

The following table describes each property in the General page.

Property	Description
Use the text of the first language for all other languages	Check this item so the object always shows the text of the first language as the operation message regardless of what the current language is. You need to enter the text of the first language in the following edit box.
Use Text From Text Database	<p>Check this item that you can select a text from the text database. The following is an example that shows you how to select and edit text from text database.</p>

13.3. Setting up Operation Log Displays

13.3.1. Basic Operations

You can display a list of operation logs by using an operation log display.

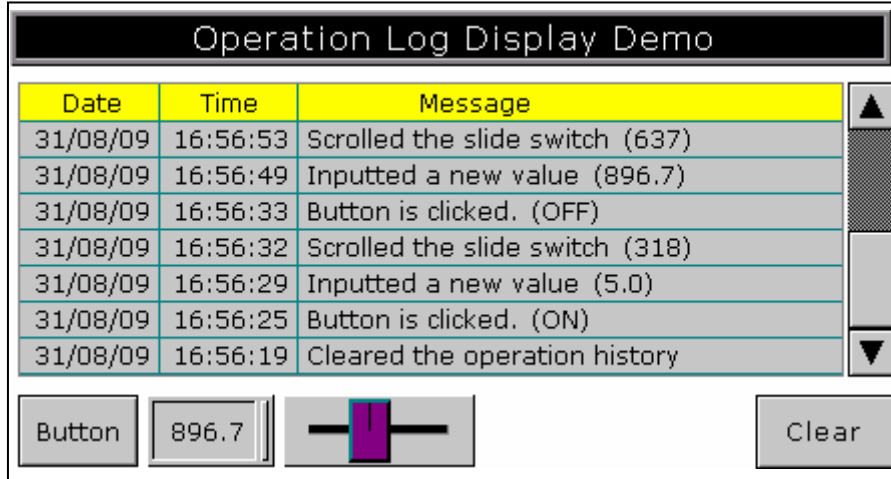

The above is an example of the operation log display. The first row is the title row. It displays the title of each column. The other rows display one operation per row. You can create scroll button groups or scroll bars to scroll the contents. An operation log display can have three columns. The following table describes the content of each column for an operation log display.

Column	Description
Date	The date when the record is created. This column is optional.
Time	The time when the record is created. This column is optional.
Message	The message of the associated operation. This column is optional.

The text color and font of a row are determined by the settings in the General Page.

13.3.2. Operation Options

The following operation option can be added to an operation log display. Select and set the option in the Operation Log Display dialog box.

Options	Description
Visibility Control	You can show and hide an operation log display with a specified bit or the current user level. Select and set this option in the Visibility page.

13.3.3. Settings

You can complete all the settings of an operation log display in the Operation Log Display dialog box. This dialog box contains the following two pages.

- **General**
Described in [Section 13.3.3.](#)
- **Visibility**
Described in [Section 4.4.6.](#)

13.3.4. General Settings

This section describes how to define the general settings for an operation log display. The following is an example of the General page of the Operation Log Display dialog box.

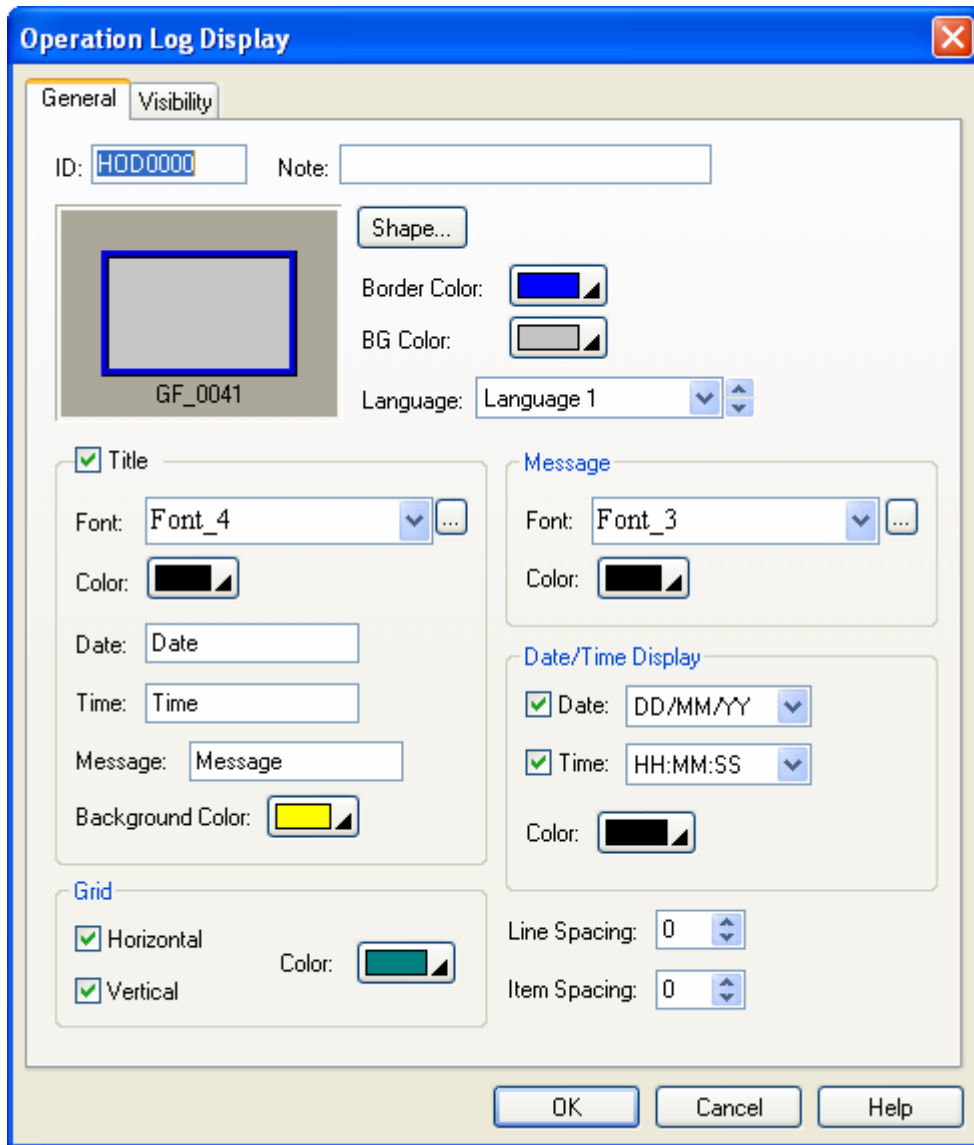

The following table describes each property in the General page.

Property	Description
ID	The object's identifier. It is generated when the object is created. The identifier is unique within the screen where the object is located and is unchangeable. The format of the IDs for the operation log display is HODnnnn.
Note	You can type a note for the object.
Shape settings	For details about the following properties, see Section 4.3.4 Setting up the Shape of an Object. <input type="button" value="Shape..."/> , Border Color, BG Color
Language	Select a language so you can view and edit the language dependent settings in the Title group and Message group for that language. The language dependent properties in the Title group include Font and Message; in the Message group include Font.

Continued

Property		Description	
Title	<Check Box>	Select this option if you want the operation log display to have a title row to show the title for each column of the displayed list.	
	Font	Select a font for the title text.	
	Color	Select a color for the text.	
	Date	Specifies the title for the Date column.	
	Time	Specifies the title for the Time column.	
	Message	Specifies the title for the Message column.	
	Background Color	Select a background color for the title row.	
Grid	Horizontal	Select this option if you want the operation log display to have horizontal grids.	
	Vertical	Select this option if you want the operation log display to have vertical grids.	
	Color	Select a color for the grids.	
Message	Font	Select a font for the message.	
	Color	Select a color for displaying the predefined message.	
Date/Time Display	Date	<Check Box>	Check this option if you want the operation log display to have the Date column.
		<Drop-down List>	Select a format for displaying the date
	Time	<Check Box>	Check this option if you want the operation log display to have the Time column.
		<Drop-down List>	Select a format for displaying the time
	Color	Select a color for Date/Time.	
Line Spacing		Specifies the extra space in pixels for two adjacent rows of the operation log display.	
Item Spacing		Specifies the extra space for every column of the operation log display.	

CHAPTER 14

USING MACROS

14.1. Types of Macros	1
14.2. Working with Macros.....	3
14.2.1. Creating Macros.....	3
14.2.2. Opening and Closing Macros	3
14.2.3. Naming a macro.....	4
14.2.4. Deleting a macro.....	4
14.2.5. Saving and Exporting Macros	4
14.2.6. Macro Settings in the Dialog	5
14.3. Writing Macros.....	7
14.3.1. Macro Editor Window	7
14.3.2. Macro Command Properties Tool Window	9
14.4. Macro Commands and Examples	10
14.4.1. Macro Notations and Terminology	10
14.4.2. Data Transfer	12
14.4.3. Arithmetic Operation	13
14.4.4. Logical Operation	14
14.4.5. Calculation.....	16
14.4.6. Data Conversion	18
14.4.7. Conditional Operation	21
14.4.8. Program Control	25
14.4.9. Timer Operation.....	28
14.4.10. Keypad Operation.....	29
14.4.11. Recipe Operation	30
14.4.12. Communication Operation.....	31
14.4.13. System Service.....	32
14.4.14. Screen Operation	33
14.4.15. File Operation	34
14.4.16. Comparison.....	40
14.4.17. String Operation.....	41
14.4.18. Run Operation.....	49
14.4.19. Print Operation.....	50
14.4.20. Sound Operation	52

This chapter explains how you can write macros to perform operations. A macro contains a sequence of macro commands and acts as a simple computer program when it is run. With macros, some tasks that are hard to be performed by the objects can be easily achieved, such as scheduling, data exchanges, conditional operations, and sequential operations.

Note: Do not use macros to control systems that can cause life-threatening and serious injury.

Note: The real-time OS in the HMI needs to manage multiple tasks at the same time when the application is running. In order to not affect the whole performance, please keep the macro as short as possible.

Note: Macros execute individually and are unaware of other macros. When sharing common variables between macros, your application may have possible conflicts. Consider an application where the cycle macro updates the value of an address which is used by the event macro. If the event macro alters the address value before the cycle macro uses that address, the result of the cycle macro will be incorrect.

14.1. Types of Macros

■ Global Macro

A global macro is a macro that can be used by all panel applications in the same project. With global macros, the panel applications in the same project can share common functions without having to keep and maintain the same set of macros locally.

You can set up a password in the Project Information & Protection dialog box to protect global macros. If global macros are under protection, you need to enter a password to remove the protection before using them in your application.

Note that only internal variables can be used in global macros.

■ Local Macro

A local macro is a macro that can only be used by the panel application which the macro is located in.

■ Sub-macro

A sub-macro is a macro that can be run by other macros using the CALL command. When a CALL command is encountered while running a macro, that macro stops running, and the sub-macro starts to run. The last command of a sub-macro must be a RET command which terminates the sub-macro and returns control to the calling macro. You can place RET commands at any location you want. The HMI will resume the execution of the calling macro starting with the command following the CALL command once the called sub-macro terminates.

By implementing common functions in sub-macros for other macros to use, your macros can be modularized, are sharable, easy to read, and easy to maintain.

■ **Startup Macro, Main Macro, Event Macro, Time Macro** for the application

■ **Open Macro, Cycle Macro, Close Macro** for the screen

■ **On Macro, Off Macro, Object Macro** for the object

Select the macro that works best for the occasion you want the macro to run, and for the purpose you want the macro to do.

Run the Macro:	Use:
When the application starts	<p>Startup Macro</p> <p>This macro is run only once when the application starts. The HMI will not display the start-up screen until the macro terminates. You can use Startup Macro to initialize global data and settings for your application. Specify Startup Macro in Panel General Setup dialog box.</p>
While the application is running	<p>Main Macro</p> <p>This macro is run all the time while the application is running. The HMI runs Main Macro cyclically, i.e. it will delay preset time to run Main Macro starting from the first command again each time after it completes the processing of the last command of the macro or when it encounters an END command in the middle of the macro. Specify Main Macro in Panel General Setup dialog box.</p>

Continued

Run the Macro:	Use:
When a specific trigger bit changes from 0 to 1	<p>Event Macro</p> <p>An Event Macro is run whenever the associated trigger bit changes from 0 (off) to 1 (on). An application can have up to four Event Macros which are numbered from 1 to 4. Specify Event Macros in the Panel General Setup dialog box.</p>
Periodically with a preset time interval	<p>Time Macro</p> <p>A Time Macro is run periodically with a preset time interval. An application can have up to four Time Macros which are numbered from 1 to 4. Each Time Macro has a different set of time interval options you can choose to specify how often you want the macro to run. Specify Time Macros in the Panel General Setup dialog box.</p>
When a specific screen is being opened	<p>Open Macro</p> <p>An Open Macro is run once when the associated screen is being opened. The screen will not be displayed until the Open Macro terminates. Specify the Open Macro of a screen in the Screen Properties dialog box.</p>
While a specific screen is open	<p>Cycle Macro</p> <p>A Cycle Macro is run all the time while the associated screen is open. The Cycle Macros runs cyclically, i.e. the Cycle Macro will run starting from the first command again every time after it completes the processing of the last command of the macro, or when an END command is encountered in the middle of the macro. The Cycle Macro terminates immediately when the screen is closed. Specify the Cycle Macro of a screen in the Screen Properties dialog box.</p>
When a specific screen is being closed	<p>Close Macro</p> <p>A Close Macro is run once when the associated screen is being closed. The screen will not be erased until the Close Macro terminates. Specify the Close Macro of a screen in the Screen Properties dialog box.</p>
When a specific button is pressed or released to set a bit to on	<p>On Macro</p> <p>An On Macro is run once when the associated button is pressed or released to set a bit to 1 (on). The setting of the bit will not be performed until the On Macro terminates. Therefore, it is important to keep the On Macro as short as possible in order to not delay the setting of the bit. Both the Bit Buttons and the Toggle Switches can have an On Macro. Specify the On Macro of a button in that button's configuration dialog box.</p>
When a specific button is pressed or released to set a bit to off	<p>Off Macro</p> <p>An Off Macro is run once when the associated button is pressed or released to set a bit to 0 (off). The setting of the bit will not be performed until the Off Macro terminates. So it is important to keep the Off Macro as short as possible in order to not delay the setting of the bit. Both Bit Buttons and Toggle Switches can have an Off Macro. Specify the Off Macro of a button in that button's configuration dialog box.</p>
When a specific object is activated to perform a specific operation	<p>Object Macro</p> <p>An Object Macro is run once when the associated object is activated to perform a specific operation. Whether the macro is run before or after the operation is performed depends on the type of the operation. The objects that can have an Object Macro include Screen Buttons, Function Buttons, and Keypad Buttons. Specify the Object Macro of an object in that object's configuration dialog box.</p>

14.2. Working with Macros

14.2.1. Creating Macros

■ Creating a new and blank macro

- 1) To create a global macro, use the Add... command on the Project > Global Macro menu, or right-click the Global > Global Macros item in the Project Manager tool window to bring out the pop-up menu and then use the Add Macro... command on the pop-up menu.

To create a local macro, use the Add... command on the Panel > Macro menu, or right-click the panel application > Macros item in the Project Manager tool window to bring out the pop-up menu and then use the Add Macro... command on the pop-up menu, or

- 2) In the New Macro dialog box, type the name you want, and hit the ENTER key or click the OK button to validate your choice.

■ Importing an existing macro as a copy macro

- 1) To import a macro as a global macro, right-click the Global > Global Macros item in the Project Manager tool window to bring out the pop-up menu and then use the Import Macro... command on the pop-up menu.

To import a macro as a local macro, right-click the panel application Macros item in the Project Manager tool window to bring out the pop-up menu and then use the Import Macro... command on the pop-up menu

- 2) Click the *.mcr or *.txt file you want to create a new macro from. If you want to open a macro that was saved in a different folder, locate and open the folder first.
- 3) Click Open.

14.2.2. Opening and Closing Macros

■ Opening an existing macro

To open a global macro, select the macro you want to open in Project > Global Macro > Edit menu, or double click the macro in Global > Global Macros item in the Project Manager tool window, or in the Macro settings of the object configuration dialog, select the macro that is located after "-----Global-----" item in the drop-down list.

To open a local macro, select the macro you want to open on Panel > Macro > Edit menu, or double click the macro in the panel application > Macros item in the Project Manager tool window, or in the Macro settings of the object configuration dialog. If global macros exist, select the macro that is located from the beginning to "-----Global-----" item in the drop-down list or select the macro in the drop-down list.

■ Opening a *.txt or *.mcr file within the macro editor window:

You may do the drag-and-drop operation:

- 1) Open the macro editor window by clicking any of the existing macros.
- 2) Drag a selection of *.mcr file or *.txt file into the macro editor window and drop it.

Note: Any macros in the macro editor window will be replaced by macros from the source file.

■ Closing Macro Editor Windows:

To close a single window, select the window and click the close button.

To close all windows, choose Windows... on the Window menu, select all the macro editor windows you want to close in the window dialog and then click Close Window(s) button.

Note: The Macro Command Properties Window will be closed automatically when the macro editor window is closed. Even if the macro editor window is closed, all the changes will be saved, unless the software exits without saving any changes to the file.

■ Closing Macro Command Properties Window:

To close the macro command properties window, click the close button on the Macro Command Properties window or check/uncheck the Macro Command Properties command on the View menu

14.2.3. Naming a macro

When adding a new macro for global use or for the panel application, you need to specify the macro name with the following dialog.

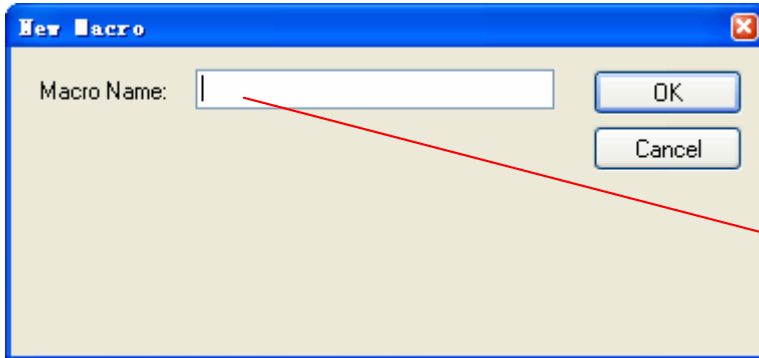

Specify the macro name here. The maximum length for a macro name is 256 characters. Macro names are case insensitive. For example, the names TURN ON and turn on are considered to be the same.

When importing a file as the macro, the file name will be the macro name as the default.

In each panel application, the local macro name has to be unique, but a local macro name can be the same as a global macro name.

■ Renaming a macro from Project Manager:

- 1) Locate the macro you would like to rename
- 2) Right-click on the macro to display the macro item's pop-up menu; and then click Rename, the second menu item.
- 3) Once the macro name is selected, simply type the new name over the selected text, and then press the ENTER key.

14.2.4. Deleting a macro

■ Deleting a macro from Project Manager tool widow:

- 1) Locate the macro you would like to delete
- 2) Right-click on the macro to display the macro item's "pop-up menu"; and then click Delete, the third menu item.

■ Deleting a macro by menu

To delete a global macro, choose Project menu, click Global Macro sub-menu, and select the macro you want to delete on the Delete sub-menu

To delete a local macro, choose Panel menu, click Macro sub-menu, and select the macro you want to delete on the Delete sub-menu

Note: You can only select one macro to delete at a time. If the macro you want to delete is used by an application or object, you will be asked to confirm the delete operation.

14.2.5. Saving and Exporting Macros

If you have a macro you want to reuse in another application panel, you can export the macro as a .txt file or a .mcr file. You may do the following:

- 1) Locate the macro you would like to export
- 2) Right-click on the macro to display the macro item's "pop-up menu"; and then click Export Macro..., the fourth menu item.
- 3) If you want to save a macro in a different folder, locate and open the folder first, then click Save.

14.2.6. Macro Settings in the Dialog

You can open and edit a specified macro or create a new macro in the configuration dialog that contains the macro page. The following is an example of the Macro page in the Bit Button configuration dialog.

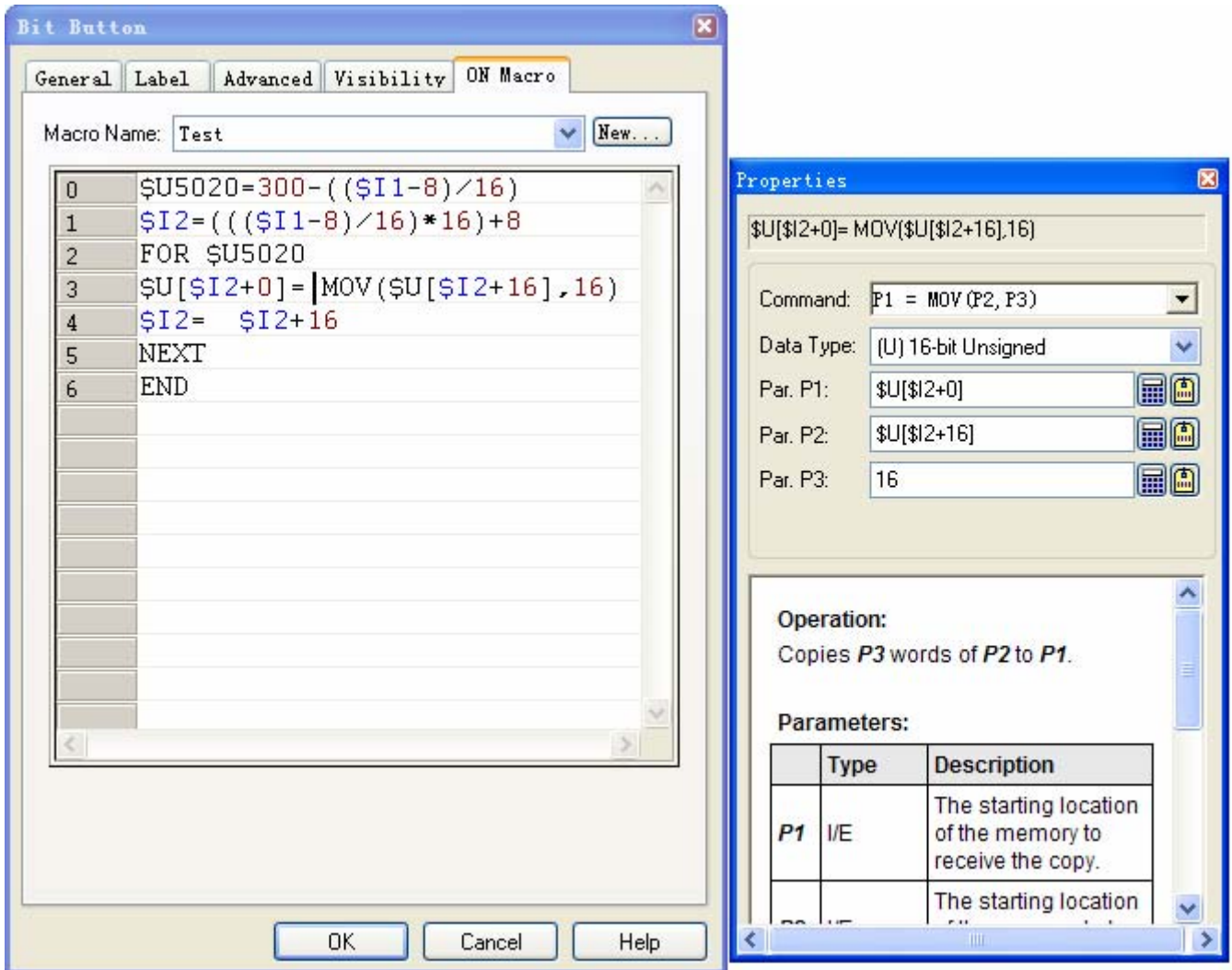

The following table describes each property in the General page.

Property	Description
Macro Name	<p>Select an existing local macro or global macro from the drop-down list. The following is a sample in the dropdown list</p> <div style="border: 1px solid black; padding: 5px; width: fit-content;"> <pre> Test SW SW SCREEN0 SW SCREEN1 SW SCREEN2 SW SCREEN3 -----Global----- On Monitor Debug </pre> </div> <p style="margin-left: 20px;">Local Macros</p> <p style="margin-left: 20px;">Global Macros</p> <p style="margin-left: 20px;">A separator that is used to separate the local macros and global macros. It shows only when global macros exist.</p>
New...	Click the button to bring out the New Macro dialog box to create a new and blank local macro.

Continued

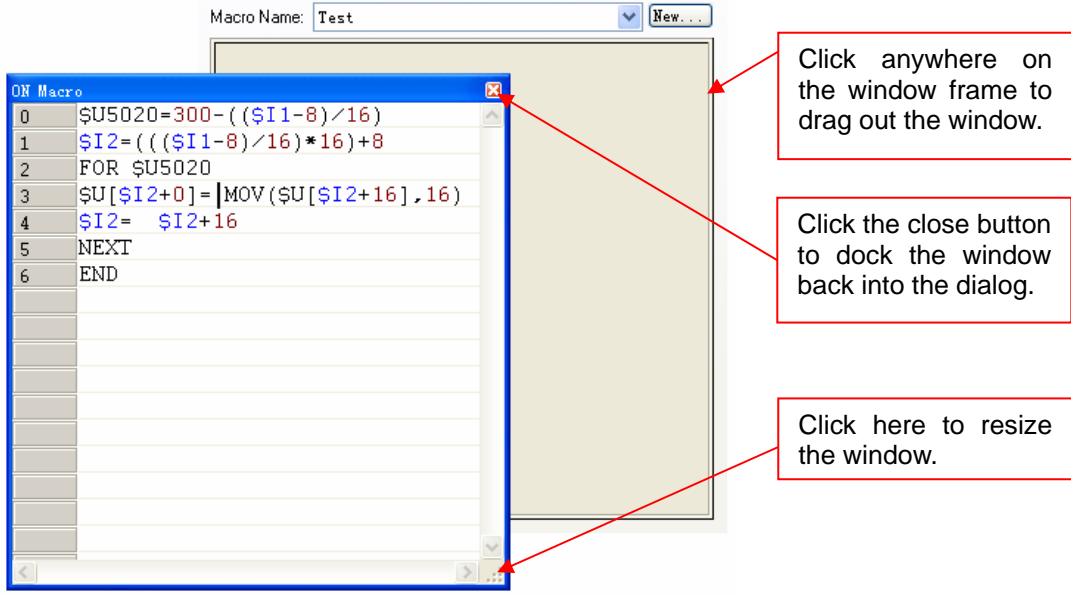
Property	Description
Macro Editor Window	<p>Write and edit the macros here. For details, see Section 14.3.1. If the editor window is too small, you may drag out the window and resize it. To drag and move the window, left-click anywhere on the window frame and hold down the button, then drag the mouse to move the window outside to another area. It will “float” over the rest of the dialog, allowing you to position it wherever you want it to be. Release the mouse button to let go of the window. Click on the resized tabs located at the bottom right corner of the window to resize the window. Press the close button to dock the window back into the dialog. The following is a sample of the floating macro editor window.</p>  <p>The screenshot shows a floating window titled "Macro Editor" with a "Macro Name: Test" field and a "New..." button. The main area contains a list of macro commands:</p> <pre> 0 \$U5020=300-(((\$I1-8)/16) 1 \$I2=(((\$I1-8)/16)*16)+8 2 FOR \$U5020 3 \$U[\$I2+0]= MOV(\$U[\$I2+16],16) 4 \$I2= \$I2+16 5 NEXT 6 END </pre> <p>Three red callout boxes provide instructions:</p> <ul style="list-style-type: none"> Click anywhere on the window frame to drag out the window. Click the close button to dock the window back into the dialog. Click here to resize the window.
Properties	<p>A floating dialog allows you specify the macro command. For details, see Section 14.3.2. The macro command properties dialog can be moved anywhere and resized to any size you want. However, it can't be closed until the dialog is closed.</p>

14.3. Writing Macros

In the software, all the macros can be written in the macro development environment that is composed of two elements: the Macro Editor Window and the Macro Command Properties Tool Window.

You will see the following sample of the Macro Development Environment when opening a macro from Project Manager.

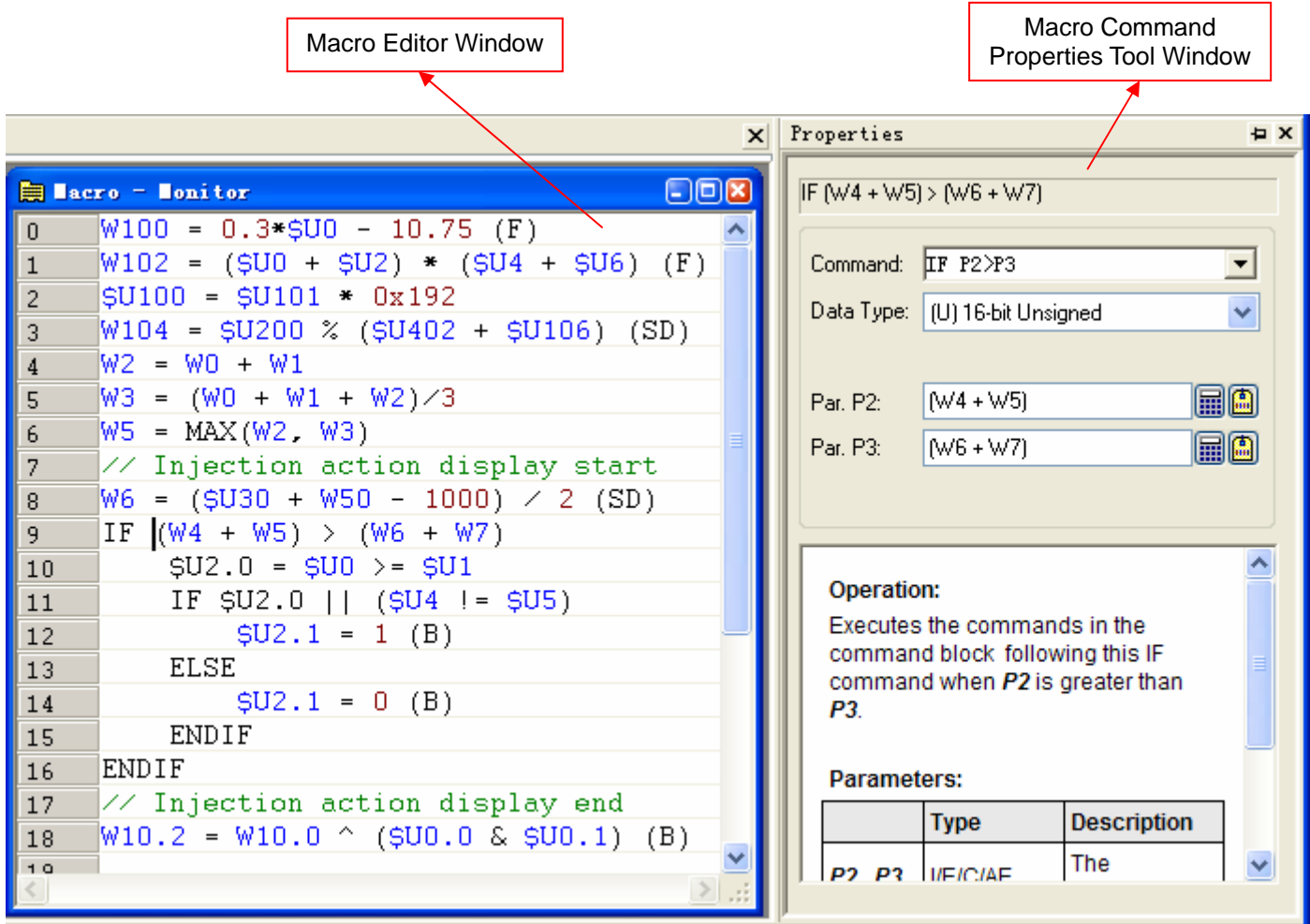

14.3.1. Macro Editor Window

The macro editor is a text-based editor with syntax coloring and line numbering. Line numbering in the left margin of the page helps you refer to the specific position of the macro. Syntax coloring gives you visual cues about the structure by using different colors for various elements, such as keywords in black, comments in green, addresses in blue and constants in red.

■ Editing Macro

With the macro editor, you can cut, copy, and paste selected text using menu commands, key combinations or drag-and-drop operations. You can also undo and redo selected editing actions.

You can right-click to display a pop-up menu of editing commands. The editing commands available depend on what the pointer is pointing to.

The macro editor allows the following editing actions:

- Cutting, copying, pasting, and deleting selection of lines, multiple lines or text
- Undoing and redoing editing actions
- Using drag-and-drop editing to move or copy a selection of text within one macro editor window, or between macro editor windows.

The following table shows the supported editing commands.

Menu Command	Key Combination	Description
Cut	CTRL+X	Removes selected text from the active macro editor window.
Copy	CTRL+C	Duplicates selected text in the active macro editor window.
Paste	CTRL+V	Pastes cut or copied text into an active macro editor window.
	DELETE	Deletes text without copying it to the Clipboard.
Undo	CTRL+Z	Reverses the last editing action.
Redo	CTRL+Y	Reapplies the prior editing that has been undone.
	CTRL+A	Selects all texts in the active macro editor

Note that all editing commands require a selection in order to work. Some commands can make a selection based on the current cursor location.

■ Using Comments in Macros

Comments are notes to be ignored when running the macro commands. Macro supports both single-line comments and block comments. Single-line comments begin with two forward slashes (//) and run to the end of the line.

The following is an example of a macro command followed by a single-line comment.

```
IF $U0.0 (B) // Key Down
```

Block comments begin with an opening delimiter (/*) and run to a closing delimiter (*). Comments do not nest.

The following is an example of a block comment.

```
/* $N1001=WH2021
   $N1010=$N1001 */
```

■ Specifying Constants in Macros

To specify a hexadecimal number, use either the h or H suffix. For example, 12abH and 3ABh are valid hexadecimal numbers. You can also use either the “0x” or “0X” prefix. For example, 0x1278abc and 0XFFFF0000 are valid hexadecimal numbers.

To specify a binary number, use either the b or B suffix. For example, 001100111b and 11110000B are valid binary numbers.

For decimal numbers, in most cases, you just type the numbers as they are to specify the constants. However, ambiguity exists when a constant is the same as a valid external variable. For example, if a panel application has a link to a Modicon ModBus slave device, it is impossible to tell whether the number 40001 is a constant or a word address of the controller. To avoid this kind of ambiguity, use the following methods to explicitly declare that a number is a constant:

- 1) Use K, k, D, or d suffix for an integer number. For example, -123K and -123d are valid specifications of constant -123.
- 2) Use either the f or F suffix for a decimal number with decimal point. For example, -12.3F and -12.3f are valid specifications of constant -12.3.



14.3.2. Macro Command Properties Tool Window

The Macro Command Properties Tool Window help you add and modify a macro command quickly and easily.

If you open a macro from Project Manager or Menu Item, the Macro Properties Tool Window will be opened as a docking window. You can easily configure the dockable tool window to automatically be displayed or hide, or tab link with other tool windows, or dock against the edges, or float over. When the Macro Editor is opened, you can also choose to open or close the Macro Command Properties Tool Window by clicking the [Macro Command Properties] menu item under [View] menu.

If you open the macro from an object's configuration dialog box, the Macro Properties Tool Window will float beside the Macro Editor and can be moved anywhere, but it can't be closed.

The following table describes each property in the macro command properties tool window.

Property		Description
Command		Click the dropdown list box to bring up the macro command selection dialog. In the dialog, navigate the keyword of macro commands through tabs and sections by moving the mouse and then clicking the selection. The format of the selected macro command will be shown in the dropdown list after the dialog is closed. To cancel the operation, click anywhere outside the macro command selection dialog.
Data Type		Selects the data type of the macro command from the dropdown list. Different macro commands support different data types. The supported data types for each macro command are some of the following: (S) 16-bit Signed, (U) 16-bit Unsigned, (SD) 32-bit Signed, (UD) 32-bit Unsigned, (F) 32-bit Floating Point, (B) Bit.
Parameter	<Edit Box>	Specifies the bit variable when the Data Type is (B) . Specifies the word variable when the Data Type is (U)/(S) . Specifies the double-word variable when the Data Type is (UD)/(SD)/(F) .
		Click this icon to bring up the Address Input Keypad and specify the desired address for the Variable field.
		Click this icon to bring up the Select Tag dialog box and select the desired tag for the Variable field.
Macro Command Help		Shows the operation and parameter type of the selected macro command.

Note that any modification in the dialog will change the current macro command in the Macro Editor.

14.4. Macro Commands and Examples

14.4.1. Macro Notations and Terminology

The following notations and terminology will be used in the Macro Commands and Examples sections.

■ Notations

- 1) *P1, P2, P3, P4, P5*: Parameters of macro commands.
- 2) *I, E, C, A, CS, M, AE, CE*: Used to indicate the type of parameter a macro command can accept for a specific command parameter.

Abbreviation	Parameter Type
I	Internal Variable
E	External Variable
C	Constant
A	ASCII character string
CS	Character string of the program label
M	Sub-macro name
AE	Arithmetic expression
CE	Comparison expression

- 3) *U, S, UD, SD, F, B*: Used to indicate the types of data a macro command can support.

Abbreviation	Data Type
U	16-bit Unsigned Integer
S	16-bit Signed Integer
UD	32-bit Unsigned Integer
SD	32-bit Signed Integer
F	32-bit Floating Point
B	Bit

■ Terminology

Terminology	Definition
Internal memory	The memory space in the HMI that can be accessed by the panel application. For example, the user memory \$U, the non-volatile memory \$N, the system memory \$S, and the recipe memory \$R are all parts of the internal memory.
Internal variable	An address or a tag referring to an address of a space in the internal memory.
Internal bit variable	An internal variable that refers to a bit in the internal memory. For ease of reading, "internal variable" is used instead of "internal bit variable" when referring to a bit if there is no ambiguity.
Internal word variable	An internal variable that refers to a word in the internal memory. The variables can also be used to refer to a double-word, a block of bytes (byte array), a block of words (word array), and a block of double-words (double-word array). For ease of reading, "internal variable" is used instead of "internal word variable" when referring to a word or a block of memory space if there is no ambiguity.
External memory	The memory space or collection of addressable devices in the controllers that can be accessed by the panel application through communication links.

Continued

Terminology	Definition																																																																																
External variable	An address or a tag referring to an address of a space in the external memory.																																																																																
External bit variable	An external variable that refers to a bit in the external memory. For ease of reading, "external variable" is used instead of "external bit variable" when referring to a bit if there is no ambiguity.																																																																																
External word variable	An external variable that refers to a word in the external memory. The variables can also be used to refer to a double-word, a block of bytes (byte array), a block of words (word array), and a block of double-words (double-word array) if the access unit of the associated addresses is word. If the access unit is double-word, you can only use the variable to refer to a double-word or a block of memory space with a length of a multiple of 4 (bytes). For ease of reading, "external variable" is used instead of "external word variable" when referring to a word or a block of memory space if there is no ambiguity.																																																																																
Expression	<table border="1"> <thead> <tr> <th>Type</th> <th>Abbreviation</th> <th>Description</th> </tr> </thead> <tbody> <tr> <td>Arithmetic Expression</td> <td>AE</td> <td>Sequences of operators and parameters that are used for computing a value from the parameters.</td> </tr> <tr> <td>Comparison Expression</td> <td>CE</td> <td>Sequences of operators and parameters that are used for comparing value from the parameters.</td> </tr> </tbody> </table> <p>The software provides the following types of operators for macro expressions:</p> <table border="1"> <thead> <tr> <th>Operators</th> <th>Name or Meaning</th> <th>Grouping</th> <th>Used for</th> </tr> </thead> <tbody> <tr> <td>()</td> <td>Parentheses</td> <td>Left to right</td> <td>AE/CE</td> </tr> <tr> <td>*</td> <td>Multiplication</td> <td>Left to right</td> <td rowspan="7">AE</td> </tr> <tr> <td>/</td> <td>Division</td> <td>Left to right</td> </tr> <tr> <td>%</td> <td>Modulus</td> <td>Left to right</td> </tr> <tr> <td>+</td> <td>Addition</td> <td>Left to right</td> </tr> <tr> <td>-</td> <td>Subtraction</td> <td>Left to right</td> </tr> <tr> <td><<</td> <td>Left shift</td> <td>Left to right</td> </tr> <tr> <td>>></td> <td>Right shift</td> <td>Left to right</td> </tr> <tr> <td><</td> <td>Less than</td> <td>Left to right</td> <td rowspan="6">CE</td> </tr> <tr> <td>></td> <td>Greater than</td> <td>Left to right</td> </tr> <tr> <td><=</td> <td>Less than or equal to</td> <td>Left to right</td> </tr> <tr> <td>>=</td> <td>Greater than or equal to</td> <td>Left to right</td> </tr> <tr> <td>==</td> <td>Equality</td> <td>Left to right</td> </tr> <tr> <td>!=</td> <td>Inequality</td> <td>Left to right</td> </tr> <tr> <td>&</td> <td>Bitwise AND</td> <td>Left to right</td> <td rowspan="3">AE</td> </tr> <tr> <td>^</td> <td>Bitwise exclusive OR</td> <td>Left to right</td> </tr> <tr> <td> </td> <td>Bitwise inclusive OR</td> <td>Left to right</td> </tr> <tr> <td>&&</td> <td>Logical AND</td> <td>Left to right</td> <td>CE</td> </tr> <tr> <td> </td> <td>Logical OR</td> <td>Left to right</td> <td>CE</td> </tr> <tr> <td>=</td> <td>Assignment</td> <td>Right to left</td> <td>AE/CE</td> </tr> </tbody> </table> <p>Note: The above table lists the operators in order of precedence (from highest to lowest precedence). Operators in the same segment of the table have equal precedence and are evaluated in the given order in an expression unless explicitly forced by parentheses.</p>	Type	Abbreviation	Description	Arithmetic Expression	AE	Sequences of operators and parameters that are used for computing a value from the parameters.	Comparison Expression	CE	Sequences of operators and parameters that are used for comparing value from the parameters.	Operators	Name or Meaning	Grouping	Used for	()	Parentheses	Left to right	AE/CE	*	Multiplication	Left to right	AE	/	Division	Left to right	%	Modulus	Left to right	+	Addition	Left to right	-	Subtraction	Left to right	<<	Left shift	Left to right	>>	Right shift	Left to right	<	Less than	Left to right	CE	>	Greater than	Left to right	<=	Less than or equal to	Left to right	>=	Greater than or equal to	Left to right	==	Equality	Left to right	!=	Inequality	Left to right	&	Bitwise AND	Left to right	AE	^	Bitwise exclusive OR	Left to right		Bitwise inclusive OR	Left to right	&&	Logical AND	Left to right	CE		Logical OR	Left to right	CE	=	Assignment	Right to left	AE/CE
Type	Abbreviation	Description																																																																															
Arithmetic Expression	AE	Sequences of operators and parameters that are used for computing a value from the parameters.																																																																															
Comparison Expression	CE	Sequences of operators and parameters that are used for comparing value from the parameters.																																																																															
Operators	Name or Meaning	Grouping	Used for																																																																														
()	Parentheses	Left to right	AE/CE																																																																														
*	Multiplication	Left to right	AE																																																																														
/	Division	Left to right																																																																															
%	Modulus	Left to right																																																																															
+	Addition	Left to right																																																																															
-	Subtraction	Left to right																																																																															
<<	Left shift	Left to right																																																																															
>>	Right shift	Left to right																																																																															
<	Less than	Left to right	CE																																																																														
>	Greater than	Left to right																																																																															
<=	Less than or equal to	Left to right																																																																															
>=	Greater than or equal to	Left to right																																																																															
==	Equality	Left to right																																																																															
!=	Inequality	Left to right																																																																															
&	Bitwise AND	Left to right	AE																																																																														
^	Bitwise exclusive OR	Left to right																																																																															
	Bitwise inclusive OR	Left to right																																																																															
&&	Logical AND	Left to right	CE																																																																														
	Logical OR	Left to right	CE																																																																														
=	Assignment	Right to left	AE/CE																																																																														

14.4.2. Data Transfer

Assignment (=)

Format	$P1 = P2$	Data Type	U/S/UD/SD/F/B
Function	Assigns the value of $P2$ to $P1$.		
$P1$ (I/E)	The destination.		
$P2$ (I/E/C/AE)	The source.		
Example 1	$\$U2 = 123.45$ (F) /* Assign 123.45 to \$U2 (and \$U3) */		
Example 2	$\$U100.f = 1$ (B) /* Turn on the specified bit */		
Example 3	$W60 = (\$U30 + \$W50 - 1000) / 2$ (SD) /* Write the result of the arithmetic expression to W60. */		
Example 4	$V0.0 = 2\backslash M0$ (B) /* Assign the bit value of M0 of link 2 to the bit V0.0 of link 1*/		

Logical NOT (= !)

Format	$P1 = ! P2$	Data Type	B
Function	Reverses $P2$ and saves the result in $P1$.		
$P1$ (I/E)	The location to save the result.		
$P2$ (I/E)	The operand.		
Example 1	$\$U2.3 = !\$U3.4$ (B) /* If \$U3.4 is 1 (On), \$U2.3 is 0 (Off) */		

.. "

Format	$P1 = "P2"$
Function	Copies the quoted ASCII character string $P2$ to $P1$. Note that the string is a null terminated string. If the length of the string is N then N+1 bytes will be copied to $P1$ and the last byte is 0.
$P1$ (I)	The location to save the result.
$P2$ (A)	The quoted ASCII character string.
Example 1	$\$U60 = "TEST"$ /* The null character (00h) will be moved to the low byte of \$U62 */
Example 2	$\$U20 = "ABCDE"$ /* The null character (00h) will be moved to the high byte of \$U22 */

MOV

Format	$P1 = \text{MOV}(P2,P3)$	Data Type	U
Function	Copies $P3$ words of $P2$ to $P1$.		
$P1$ (I/E)	The starting location of the memory to receive the copy.		
$P2$ (I/E)	The starting location of the memory to be copied.		
$P3$ (I/C)	The number of words to be copied.		
Example 1	$\$U100 = \text{MOV}(\$U200, 16)$ /* Copy the 16 words starting from \$U200 to \$U100 */		
Example 2	$W60 = \text{MOV}(\$U200, \$U2)$ /* Copy the word array starting from \$U200 with the size specified in \$U2 to W60.*/		
Example 3	$\$U10 = \text{MOV}(2\backslash D100,10)$ /* Copy D100 ~ D109 of link 2 to \$U10 ~ \$U19.*/		

SETM

Format	$P1 = \text{SETM}(P2, P3)$	Data Type	U
Function	Sets $P3$ words of $P1$ to word value $P2$.		
$P1$ (I/E)	The starting location of the memory to be set.		
$P2$ (I/C)	The set value or the location that holds the set value.		
$P3$ (I/C)	The number of words to be set. The max. no. of words are 512.		
Example 1	$\$U100 = \text{SETM}(0, 16)$ /* Set the 16 words starting from $\$U100$ to 0. */		
Example 2	$W60 = \text{SETM}(\$U200, \$U2)$ /* Set the words of the word array starting from $W60$ with the size specified in $\$U2$ to the value of $\$U200$.*/		

14.4.3. Arithmetic Operation

Addition (+)

Format	$P1 = P2 + P3$	Data Type	U/S/UD/SD/F
Function	Adds $P2$ and $P3$ and saves the result in $P1$.		
$P1$ (I/E)	The location to save the result.		
$P2, P3$ (I/E/C/AE)	The operands.		
Example 1	$\$U100 = \$U101 + \$U102$ (U)		
Example 2	$W100 = 0.3*\$U0 + 0.1*\$U2 + 0.6*\$U4$ (F)		

Subtraction (-)

Format	$P1 = P2 - P3$	Data Type	U/S/UD/SD/F
Function	Subtracts $P3$ from $P2$ and saves the result in $P1$.		
$P1$ (I/E)	The location to save the result.		
$P2, P3$ (I/E/C/AE)	The operands.		
Example 1	$\$U100 = \$U101 - \$U102$ (U)		
Example 2	$W100 = 0.3*\$U0 - 10.75$ (F)		

Multiplication (*)

Format	$P1 = P2 * P3$	Data Type	U/S/UD/SD/F
Function	Multiplies $P2$ by $P3$ and saves the product in $P1$.		
$P1$ (I/E)	The location to save the product. If the product overflows, the higher bits exceeding the limit will be truncated and the remaining bits will be stored in $P1$.		
$P2, P3$ (I/E/C/AE)	The operands.		
Example 1	$\$U100 = \$U102 * 0x192$		
Example 2	$W100 = (\$U0 + \$U2) * (\$U4 + \$U6)$ (F)		

Division (/)

Format	$P1 = P2 / P3$	Data Type	U/S/UD/SD/F
Function	Divides P2 by P3 and saves the quotient in P1 .		
P1 (I/E)	The location to save the result.		
P2,P3 (I/E/C/AE)	The operands.		
Example 1	$\$U100 = \$U101 / \$U102$ (U)		
Example 2	$W100 = (\$U0 + \$U2) / (\$U4 + \$U6)$ (F)		

Modulus (%)

Format	$P1 = P2 \% P3$	Data Type	U/S/UD/SD
Function	Divides P2 by P3 and saves the remainder in P1 .		
P1 (I/E)	The location to save the result.		
P2,P3 (I/E/C/AE)	The operands.		
Example 1	$\$U100 = \$U30 \% 16$ (U)		
Example 2	$W100 = \$U200 \% (\$U402 + \$U106)$ (SD)		

14.4.4. Logical Operation

Bitwise Inclusive OR (|)

Format	$P1 = P2 P3$	Data Type	U/UD/B
Function	Performs bitwise Inclusive OR operation of P2 and P3 and saves the results in P1 .		
P1 (I/E)	The location to save the result.		
P2,P3 (I/E/C)	The operands		
Example 1	$W60 = 1111000000001111b$ $\$U100 = 0000111100001111b W60$ (U) /* The value of \$U100 is 1111111100001111b */		
Example 2	$B15 = \$U1.2 B14$ (B) /* If either \$U1.2 or B14 has a value of 1(On), B15 has the value 1(On). Otherwise, B15 has the value 0(Off)*/		

Bitwise AND (&)

Format	$P1 = P2 \& P3$	Data Type	U/UD/B
Function	Performs bitwise AND operation of P2 and P3 and saves the results in P1 .		
P1 (I/E)	The location to save the result.		
P2,P3 (I/E/C)	The operands		
Example 1	$W60 = 1111000000001111b$ $\$U100 = 0000111100001111b \& W60$ (U) /* The value of \$U100 is 0000000000001111b */		
Example 2	$B15 = \$U1.2 \& B14$ (B) /* If both \$U1.2 and B14 are 1(On), B15 is set to 1(On). Otherwise B15 is set to 0(Off) */		

Bitwise Exclusive OR (^)

Format	$P1 = P2 \wedge P3$	Data Type	U/UD/B
Function	Performs bitwise Exclusive OR operation of $P2$ and $P3$ and saves the results in $P1$.		
$P1$ (I/E)	The location to save the result.		
$P2, P3$ (I/E/C)	The operands		
Example 1	$W60 = 1111000000001111b$ $\$U100 = 0000111100001111b \wedge W60$ (U) /* The value of $\$U100$ is 1111111100000000b.*/		
Example 2	$B15 = \$U1.2 \wedge B14$ (B) /*If both $\$U1.2$ and $B14$ are 1(On) or 0(Off), the $B15$ is set to 0(Off). Otherwise $B15$ is set to 1(On)*/		

Left Shift (<<)

Format	$P1 = P2 \ll P3$	Data Type	U/UD
Function	Shifts $P2$ to the left by $P3$ bits and saves the results in $P1$. The operation supports the logic shift only.		
$P1$ (I/E)	The location to save the result.		
$P2$ (I/E/C)	The value or the location that holds the value to be shifted.		
$P3$ (I/E/C)	The number of bits to be shifted.		
Example 1	$\$U100 = \$U101 \ll 8$ (U)		
Example 2	$W200 = W100 \ll \$U10$ (UD)		

Right Shift (>>)

Format	$P1 = P2 \gg P3$	Data Type	U/UD
Function	Shifts $P2$ to the right by $P3$ bits and saves the results in $P1$. The operation supports the logic shift only.		
$P1$ (I/E)	The location to save the result.		
$P2$ (I/E/C)	The value or the location that holds the value to be shifted.		
$P3$ (I/E/C)	The number of bits to be shifted.		
Example 1	$\$U100 = \$U101 \gg 8$ (U)		
Example 2	$W200 = W100 \gg \$U10$ (UD)		

Logical AND (&&)

Format	$P1 = P2 \&\& P3$	Data Type	B
Function	Saves 1 in $P1$ if both $P2$ and $P3$ are 1, otherwise saves 0 in $P1$.		
$P1$ (I/E)	The bit to save the result.		
$P2, P3$ (I/E/C)	The operands.		
Example 1	$\$U100.0 = \$U101.0 \&\& \$U101.1$ (B)		

Logical OR (||)

Format	$P1 = P2 P3$	Data Type	B
Function	Saves 1 in P1 if either or both P2 and P3 are 1, otherwise saves 0 in P1 .		
P1 (I/E)	The bit to save the result.		
P2,P3(I/E/C)	The operands.		
Example 1	$\$U100.0 = \$U101.0 \$U101.1$ (B)		

14.4.5. Calculation

MAX

Format	$P1 = MAX(P2,P3)$	Data Type	U/S/UD/SD/F
Function	Sets P1 to the larger value of P2 and P3 .		
P1 (I/E)	The location to save the result.		
P2,P3(I/E/C)	The operands.		
Example 1	$\$U100 = MAX(100, 200)$ /* Set \$U100 to 200 */		

MIN

Format	$P1 = MIN(P2,P3)$	Data Type	U/S/UD/SD/F
Function	Sets P1 to the smaller value of P2 and P3 .		
P1 (I/E)	The location to save the result.		
P2,P3(I/E/C)	The operands.		
Example 1	$\$U100 = MIN(100, 200)$ /* Set \$U100 to 100 */		

BMAX

Format	$P1 = BMAX(P2,P3)$	Data Type	U/S/UD/SD/F
Function	Finds the maximum in an array starting from P2 with P3 elements and saves the result in P1 .		
P1 (I)	The location to save the result.		
P2 (I)	The starting location of the array.		
P3 (I/C)	The size of the array.		
Example 1	$\$U100 = BMAX(\$U200, 16)$ (F) /* Find the maximum among 16 floating point numbers starting from \$U200 and save the result in \$U100 */		

BMIN

Format	$P1 = BMIN(P2,P3)$	Data Type	U/S/UD/SD/F
Function	Finds the minimum in an array starting from P2 with P3 elements and saves the result in P1 .		
P1 (I)	The location to save the result.		
P2 (I)	The starting location of the array.		
P3 (I/C)	The size of the array.		
Example 1	$\$U100 = BMIN(\$U200, 60)$ (F) /* Find the minimum among 60 floating point numbers starting from \$U200 and save the result in \$U100 */		

SUM

Format	$P1 = \text{SUM}(P2, P3)$	Data Type	U/S/UD/SD/F
Function	Calculates the sum of the value in an array starting from $P2$ with $P3$ elements and saves the result in $P1$.		
$P1$ (I)	The location to save the result.		
$P2$ (I)	The starting location of the array.		
$P3$ (I/C)	The size of the array.		
Example 1	$\$U100 = \text{SUM}(\$U200, 16)$ (F) /* Calculate the sum of 16 floating point numbers starting from \$U200 and save the result in \$U100 */		

XSUM

Format	$P1 = \text{XSUM}(P2, P3)$	Data Type	U/UD
Function	Calculates one element XOR (Bitwise Exclusive OR) sum of all the $P3$ elements in an array starting from $P2$ and saves the result in $P1$.		
$P1$ (I)	The location to save the result.		
$P2$ (I)	The starting location of the array.		
$P3$ (I/C)	The size of the array.		
Example 1	$\$U100 = \text{XSUM}(\$U200, 5)$ (UD) /* Perform XOR sum of 5 32-bit unsigned numbers starting from \$U200 and save the result in \$U100. Another expression of XOR sum is $\$U100 = \$U200 \wedge \$U202 \wedge \$U204 \wedge \$U206 \wedge \$U208$ (UD) */ $\$U100 = 1001\text{B}$ $\$U101 = 1100\text{B}$ $\$U102 = 0110\text{B}$ $\$U120 = \text{XSUM}(\$U100, 3)$ /* \$U120=0011B */		

SWAP

Format	$\text{SWAP}(P1, P2)$	Data Type	U
Function	Swaps the low byte and high byte of every word in a word array starting from $P1$ with $P2$ words.		
$P1$ (I)	The starting location of the array.		
$P2$ (I/C)	The size of the array.		
Example 1	$\$U120 = 1111111100000000\text{B}$ $\$U121 = 1000000100000000\text{B}$ $\text{SWAP}(\$U120, 2)$ /* The value of \$U120 will be 0000000011111111B, The value of \$U121 will be 000000010000001B */		

14.4.6. Data Conversion

BCD

Format	$P1 = \text{BCD}(P2)$	Data Type	U/UD
Function	Converts binary number $P2$ to a BCD number and saves the result in $P1$.		
$P1$ (I/E)	The location to save the result.		
$P2$ (I/E/C)	The binary number to be converted.		
Example 1	$\$U100 = \text{BCD}(0x1234)$ (U) /* The value of \$U100 will be 1234. */		

BIN

Format	$P1 = \text{BIN}(P2)$	Data Type	U/UD
Function	Converts BCD number $P2$ to a binary number and saves the result in $P1$.		
$P1$ (I/E)	The location to save the result.		
$P2$ (I/E/C)	The BCD number to be converted.		
Example 1	$\$U100 = \text{BIN}(1234)$ (U) /* The value of \$U100 will be 0x1234. */		

DW

Format	$P1 = \text{DW}(P2)$	Data Type	U/S
Function	Converts 16-bit number $P2$ to a 32-bit number and saves the result in $P1$.		
$P1$ (I/E)	The location to save the result.		
$P2$ (I/E/C)	The 16-bit number to be converted.		
Example 1	$\$U100 = \text{DW}(12345)$ (S) /* The value of \$U100 will be 12345 and the value of \$U101 will be 0. */		
Example 2	$\$U200 = \text{DW}(-12345)$ (S) /* The value of \$U200 will be -12345 and the value of \$U201 will be 0xFFFF. */		

W

Format	$P1 = \text{W}(P2)$	Data Type	UD/SD
Function	Converts 32-bit number $P2$ to a 16-bit number and saves the result in $P1$. The truncation error may occur.		
$P1$ (I/E)	The location to save the result.		
$P2$ (I/E/C)	The 32-bit number to be converted.		
Example 1	$\$U100 = \text{W}(0x12345678)$ (UD) /* The value of \$U100 will be 0x5678 */		
Example 2	$\$U200 = \text{W}(-12345)$ (SD) /* The value of \$U200 will be -12345 */		

B2W

Format	$P1 = B2W(P2,P3)$	Data Type	U
Function	Converts $P3$ -byte array starting from $P2$ to a $P3$ -word array and saves the result in $P1$. All the high bytes of the word array are set to 0.		
$P1$ (I)	The location (or the word array) to save the result.		
$P2$ (I)	The byte array to be converted.		
$P3$ (I/C)	The size of the byte array.		
Example 1	$\$U200 = 0x45FA$ $\$U201 = 0xEB29$ $\$U100 = B2W(\$U200, 3) /*$ Convert 3 bytes starting from $\$U200$ to 3 words starting from $\$U100$, $\$U100$ will be $0xFA$, $\$U101$ will be $0x45$ and $\$U102$ will be $0x29$. $*/$		

W2B

Format	$P1 = W2B(P2,P3)$	Data Type	U
Function	Converts a word array $P2$ with $P3$ elements to a byte array and saves the result in the byte array $P1$. The conversion discards the high byte of every element of the word array to form a byte array with the same number of elements. The array size cannot exceed 256.		
$P1$ (I)	The location (or the word array) to save the result.		
$P2$ (I)	The word array to be converted.		
$P3$ (I/C)	The size of the word array.		
Example 1	$\$U200 = 0x45FA$ $\$U201 = 0xEB29$ $\$U202 = 0xC781$ $\$U100 = W2B(\$U200, 3) /*$ Convert 3 words starting from $\$U200$ to 3 bytes starting from $\$U100$, $\$U100$ will be $0x29FA$ and the low byte of $\$U101$ will be $0x81$. $*/$		

A2X

Format	$P1 = A2X(P2)$	Data Type	U
Function	Converts a 4-digit hex number in ASCII character form to a binary number and saves the result in $P1$. The character of the fourth digit is in the first word of the word array $P2$ and the characters of the other digits are in the following words in sequence.		
$P1$ (I)	The location to save the result.		
$P2$ (I)	The word array that contains the characters to be converted.		
Example 1	$\$U20 = 49 // '1'$ $\$U21 = 50 // '2'$ $\$U22 = 69 // 'E'$ $\$U23 = 70 // 'F'$ $\$U100 = A2X(\$U20) /*$ The value of $\$U100$ will be $0x12EF$. $*/$		

X2A

Format	$P1 = X2A(P2)$	Data Type	U
Function	Converts 16-bit number $P2$ to a 4-digit hex number in ASCII character form and saves the result in word array $P1$. The character of the fourth digit is saved in the first word of $P1$ and the characters of the other digits are saved in the following words in sequence.		
$P1$ (I)	The location (or the word array) to save the result.		
$P2$ (I/C)	The number to be converted.		
Example 1	$\$U10 = X2A(0x34AB)$ /*The 4 words starting from $\$U10$ will be: 51('3'), 52('4'), 65('A'), 66('B') */		

W2F

Format	$P1 = W2F(P2)$	Data Type	U/S
Function	Converts 16-bit number $P2$ to a floating point number and saves the result in $P1$.		
$P1$ (I/E)	The location to save the result.		
$P2$ (I/E/C)	The 16-bit number to be converted.		
Example 1	$\$U200 = W2F(\$U10)$ (S)		

D2F

Format	$P1 = D2F(P2)$	Data Type	UD/SD
Function	Converts 32-bit number $P2$ to a floating point number and saves the result in $P1$.		
$P1$ (I/E)	The location to save the result.		
$P2$ (I/E/C)	The 32-bit number to be converted.		
Example 1	$\$U200 = D2F(\$U10)$ (SD)		

F2W

Format	$P1 = F2W(P2)$	Data Type	F
Function	Converts floating point number $P2$ to a 16-bit number and saves the result in $P1$.		
$P1$ (I/E)	The location to save the result.		
$P2$ (I/E/C)	The floating point number to be converted.		
Example 1	$\$U200 = F2W(\$U10)$ (F)		

F2D

Format	$P1 = F2D(P2)$	Data Type	F
Function	Converts floating point number $P2$ to a 32-bit number and saves the result in $P1$.		
$P1$ (I/E)	The location to save the result.		
$P2$ (I/E/C)	The floating point number to be converted.		
Example 1	$\$U200 = F2D(\$U10)$ (F)		

EXTRACT_BIT

Format	$P1 = \text{EXTRACT_BIT}(P2,P3)$	Data Type	U/UD
Function	Extracts bit $P3$ from $P2$ and saves the result in $P1$.		
$P1$ (I)	The bit to save the result.		
$P2$ (I)	The location to extract the bit.		
$P3$ (I/C)	The number of the bit to be extracted.		
Example 1	<code>\$U2.0 = EXTRACT_BIT(\$U10, 31) (UD) /* Extract bit 31 of the double word \$U10 and save the result in \$U2.0 */</code>		

14.4.7. Conditional Operation

IF ==

Format	IF $P2 == P3$	Data Type	U/S/UD/SD/F
Function	Executes the commands in the command block following this IF command when $P2$ is equal to $P3$.		
$P2,P3$ (I/E/C/AE)	The operands.		

IF !=

Format	IF $P2 != P3$	Data Type	U/S/UD/SD/F
Function	Executes the commands in the command block following this IF command when $P2$ is not equal to $P3$.		
$P2,P3$ (I/E/C/AE)	The operands.		

IF >

Format	IF $P2 > P3$	Data Type	U/S/UD/SD/F
Function	Executes the commands in the command block following this IF command when $P2$ is greater than $P3$.		
$P2,P3$ (I/E/C/AE)	The operands.		

IF >=

Format	IF $P2 >= P3$	Data Type	U/S/UD/SD/F
Function	Executes the commands in the command block following this IF command when $P2$ is greater than or equal to $P3$.		
$P2,P3$ (I/E/C/AE)	The operands.		

IF <

Format	IF $P2 < P3$	Data Type	U/S/UD/SD/F
Function	Executes the commands in the command block following this IF command when $P2$ is less than $P3$.		
$P2,P3$ (I/E/C/AE)	The operands.		

IF <=

Format	IF $P2 \leq P3$	Data Type	U/S/UD/SD/F
Function	Executes the commands in the command block following this IF command when $P2$ is less than or equal to $P3$.		
$P2, P3$ (I/E/C/AE)	The operands.		

IF &

Format	IF $P2 \& P3$	Data Type	U/UD
Function	Executes the commands in the command block following this IF command when the result of Bitwise AND between $P2$ and $P3$ is non-zero.		
$P2, P3$ (I/E/C/AE)	The operands.		

IF !&

Format	IF $!(P2 \& P3)$	Data Type	U/UD
Function	Executes the commands in the command block following this IF command when the result of Bitwise AND between $P2$ and $P3$ is zero.		
$P2, P3$ (I/E/C/AE)	The operands.		

IF <bit>

Format	IF $P2$	Data Type	B
Function	Executes the commands in the command block following this IF command if the condition $P2$ is true (1/On).		
$P2$ (I/E/CE)	The condition.		

IF !<bit>

Format	IF $!P2$	Data Type	B
Function	Executes the commands in the command block following this IF command if the condition $P2$ is false (0/Off).		
$P2$ (I/E/CE)	The condition.		

ELIF ==

Format	ELIF $P2 == P3$	Data Type	U/S/UD/SD/F
Function	Executes the commands in the command block following this ELIF command when $P2$ is equal to $P3$.		
$P2, P3$ (I/E/C/AE)	The operands.		

ELIF !=

Format	ELIF $P2 != P3$	Data Type	U/S/UD/SD/F
Function	Executes the commands in the command block following this ELIF command when $P2$ is not equal to $P3$.		
$P2, P3$ (I/E/C/AE)	The operands.		

ELIF >

Format	ELIF <i>P2</i> > <i>P3</i>	Data Type	U/S/UD/SD/F
Function	Executes the commands in the command block following this ELIF command when <i>P2</i> is greater than <i>P3</i> .		
<i>P2,P3</i> (I/E/C/AE)	The operands.		

ELIF >=

Format	ELIF <i>P2</i> >= <i>P3</i>	Data Type	U/S/UD/SD/F
Function	Executes the commands in the command block following this ELIF command when <i>P2</i> is greater than or equal to <i>P3</i> .		
<i>P2,P3</i> (I/E/C/AE)	The operands.		

ELIF <

Format	ELIF <i>P2</i> < <i>P3</i>	Data Type	U/S/UD/SD/F
Function	Executes the commands in the command block following this ELIF command when <i>P2</i> is less than <i>P3</i> .		
<i>P2,P3</i> (I/E/C/AE)	The operands.		

ELIF <=

Format	ELIF <i>P2</i> <= <i>P3</i>	Data Type	U/S/UD/SD/F
Function	Executes the commands in the command block following this ELIF command when <i>P2</i> is less than or equal to <i>P3</i> .		
<i>P2,P3</i> (I/E/C/AE)	The operands.		

ELIF &

Format	ELIF <i>P2</i> & <i>P3</i>	Data Type	U/UD
Function	Executes the commands in the command block following this ELIF command when the result of Bitwise AND between <i>P2</i> and <i>P3</i> is non-zero.		
<i>P2,P3</i> (I/E/C/AE)	The operands.		

ELIF !&

Format	ELIF !(<i>P2</i> & <i>P3</i>)	Data Type	U/UD
Function	Executes the commands in the command block following this ELIF command when the result of Bitwise AND between <i>P2</i> and <i>P3</i> is zero.		
<i>P2,P3</i> (I/E/C/AE)	The operands.		

ELIF <bit>

Format	ELIF <i>P2</i>	Data Type	B
Function	Executes the commands in the command block following this ELIF command if the condition <i>P2</i> is true (1/On).		
<i>P2</i> (I/E/CE)	The condition.		

ELIF !<bit>

Format	ELIF !P2	Data Type	B
Function	Executes the commands in the command block following this ELIF command if the condition P2 is false (0/Off).		
P2 (I/E/CE)	The condition.		

ELSE

Format	ELSE
Function	This command specifies the beginning of the default command block that will be executed if none of the conditions in the preceding IF and/or ELIF commands is true. This is not an executable command.

ENDIF

Format	ENDIF	
Function	This command specifies the end of a command block, which begins at the command following the matching IF, ELIF, or ELSE command. This is not an executable command.	
Example	IF-Command Structures:	
	Commands and Structures	Description
	IF <condition> ... ENDIF	Runs the command block between IF and ENDIF when the condition is true, otherwise ignores the command block.
	IF <condition> ... ELSE ... ENDIF	Runs the command block between IF and ELSE when the condition is true, otherwise runs the command block between ELSE and ENDIF.
	IF <condition> ... ELIF <condition_2> ... ELIF <condition_3> . . . ELIF <condition_N> ... ENDIF	Runs the command block between IF and the first ELIF and ignores all the following commands in the structure when condition 1 is true, otherwise examines condition 2. Runs the command block between the first ELIF and the second ELIF and ignores all the following commands in the structure when condition 2 is true, otherwise checks condition 3. Repeats the same operation until condition N is processed. If none of the conditions are true, no command block in this structure is run.
IF <condition> ... ELIF <condition_2> ... ELIF <condition_3> . . . ELIF <condition_N> ... ELSE ... ENDIF	Runs the command block between IF and the first ELIF and ignores all the following commands in the structure when condition 1 is true, otherwise examines condition 2. Runs the command block between the first ELIF and the second ELIF and ignores all the following commands in the structure when condition 2 is true, otherwise checks condition 3. Repeats the same operation until condition N is processed. Runs the command block between ELSE and ENDIF if none of the conditions are true.	
Note that there can be up to 20 nested IF-command structures.		

14.4.8. Program Control

JMP

Format	JMP <i>P1</i>
Function	Unconditionally jumps to the program point specified by label <i>P1</i> .
<i>P1</i> (CS)	The label of the program point.
Example 1	<pre>IF \$U10 == 0 JMP SKIP /* Skip the command "\$U20 = \$U10 / 2". */ ENDIF \$U20 = \$U10 / 2 SKIP: \$U10 = 1</pre>

<label>

Format	<i>P1</i>:
Function	This is not an executable command. The <i>P1</i> is the label of the program point where it is positioned.
<i>P1</i> (CS)	The character string as the label of the program point. Remember to have the character ':' after the label.
Example 1	<pre>IF \$U10 == 0 JMP SKIP /* Skip the command "\$U20 = \$U10 / 2" */ ENDIF \$U20 = \$U10 / 2 SKIP: \$U10 = 1</pre>

JMP ==

Format	JMP(<i>P1</i>,<i>P2</i> == <i>P3</i>)	Data Type	U/S/UD/SD/F
Function	Jumps to the program point specified by label <i>P1</i> when <i>P2</i> is equal to <i>P3</i> .		
<i>P1</i> (CS)	The label of the program point.		
<i>P2</i>,<i>P3</i> (I/E/C/AE)	The operands.		

JMP !=

Format	JMP(<i>P1</i>,<i>P2</i> != <i>P3</i>)	Data Type	U/S/UD/SD/F
Function	Jumps to the program point specified by label <i>P1</i> when <i>P2</i> is not equal to <i>P3</i> .		
<i>P1</i> (CS)	The label of the program point.		
<i>P2</i>,<i>P3</i> (I/E/C/AE)	The operands.		

JMP >

Format	JMP(<i>P1</i>,<i>P2</i> > <i>P3</i>)	Data Type	U/S/UD/SD/F
Function	Jumps to the program point specified by label <i>P1</i> when <i>P2</i> is greater than <i>P3</i> .		
<i>P1</i> (CS)	The label of the program point.		
<i>P2</i>,<i>P3</i> (I/E/C/AE)	The operands.		

JMP >=

Format	JMP(<i>P1</i>,<i>P2</i> >= <i>P3</i>)	Data Type	U/S/UD/SD/F
Function	Jumps to the program point specified by label <i>P1</i> when <i>P2</i> is greater than or equal to <i>P3</i> .		
<i>P1</i> (CS)	The label of the program point.		
<i>P2</i> , <i>P3</i> (I/E/C/AE)	The operands.		

JMP <

Format	JMP(<i>P1</i>,<i>P2</i> < <i>P3</i>)	Data Type	U/S/UD/SD/F
Function	Jumps to the program point specified by label <i>P1</i> when <i>P2</i> is less than <i>P3</i> .		
<i>P1</i> (CS)	The label of the program point.		
<i>P2</i> , <i>P3</i> (I/E/C/AE)	The operands.		

JMP <=

Format	JMP(<i>P1</i>,<i>P2</i> <= <i>P3</i>)	Data Type	U/S/UD/SD/F
Function	Jumps to the program point specified by label <i>P1</i> when <i>P2</i> is less than or equal to <i>P3</i> .		
<i>P1</i> (CS)	The label of the program point.		
<i>P2</i> , <i>P3</i> (I/E/C/AE)	The operands.		

JMP &

Format	JMP(<i>P1</i>,<i>P2</i> & <i>P3</i>)	Data Type	U/UD
Function	Jumps to the program point specified by label <i>P1</i> when the result of Bitwise AND between <i>P2</i> and <i>P3</i> is non-zero.		
<i>P1</i> (CS)	The label of the program point.		
<i>P2</i> , <i>P3</i> (I/E/C/AE)	The operands.		

JMP !&

Format	JMP(<i>P1</i>,!(<i>P2</i> & <i>P3</i>))	Data Type	U/UD
Function	Jumps to the program point specified by label <i>P1</i> when the result of Bitwise AND between <i>P2</i> and <i>P3</i> is zero.		
<i>P1</i> (CS)	The label of the program point.		
<i>P2</i> , <i>P3</i> (I/E/C/AE)	The operands.		

JMP <bit>

Format	JMP(<i>P1</i>,<i>P2</i>)	Data Type	B
Function	Jumps to the program point specified by label <i>P1</i> if the condition <i>P2</i> is true (1/On).		
<i>P1</i> (CS)	The label of the program point.		
<i>P2</i> , <i>P3</i> (I/E/CE)	The operands.		

JMP !<bit>

Format	JMP(P1,!P2)	Data Type	B
Function	Jumps to the program point specified by label P1 if the condition P2 is false (0/Off).		
P1 (CS)	The label of the program point.		
P2,P3 (I/E/CE)	The operands.		

CALL

Format	CALL P1
Function	Goes to sub-macro P1 .
P1 (Sub-macro name)	The sub-macro to be called.
Example 1	CALL CommonFunction_01 /* Go to sub-macro named CommonFuncation_01 */

RET

Format	RET
Function	Returns to the calling macro. This command can only be used in sub-macros.

FOR

Format	FOR P2	Data Type	U
Function	Runs the commands within the FOR loop by P1 times. A FOR loop is enclosed by a matching pair of FOR and NEXT commands. There can be up to 20 nested FOR loops.		
P1 (I/C)	Total times to run the FOR loop		
Example 1	<pre>FOR 10 \$U100 = \$U100 + 1 /* This command will be executed 10 times */ FOR 12 \$U200 = \$U200 + 1 /* This command will be executed 120 times */ NEXT NEXT</pre>		

NEXT

Format	NEXT
Function	This command indicates the end of a FOR loop. It is not an executable command.
Example 1	<p>Example:</p> <pre>\$U1 = 10 \$U2 = 12 FOR \$U1 \$U100 = \$U100 + 1 /* This command will be executed 10 times. */ FOR \$U2 \$U200 = \$U200 + 1 /* This command will be executed 120 times. */ NEXT NEXT</pre>

STOP

Format	STOP
Function	Stops the macro immediately. If the macro is a Cycle macro, it will run again starting from the first command when the associated window is opened again. If the macro is a Main macro, it will run again starting from the first command when restarting the application. This command cannot be used in sub-macros.

END

Format	END
Function	Indicates the end of macro and stops the macro in the current cycle. It can be put anywhere in a macro to stop the macro at any point. If the macro is a cyclic macro, such as the Main macro and the Cycle macro, it is stopped just in the current cycle and will be run again starting from the first command in the next cycle. This command cannot be used in sub-macros.

14.4.9. Timer Operation

SET_T

Format	SET_T(P1,P2)	Data Type	U															
Function	Starts the timer <i>P1</i> using the timer control block in <i>P2</i> .																	
P1 (C)	The ID of the timer. There are 8 timers available and the IDs are 0 to 7.																	
P2 (l)	<p>The starting location of the memory block (or word array) that is used as a Timer Control Block for the timer. The structure of the Timer Control Block is shown below:</p> <table border="1"> <thead> <tr> <th>Word No.</th> <th>Data Item</th> <th>Description</th> </tr> </thead> <tbody> <tr> <td>0</td> <td>Type of operation</td> <td>0: One-shot; 1: Square-wave</td> </tr> <tr> <td>1</td> <td>Current timer value</td> <td>The timer increases the value of this word by 1 every 100ms.</td> </tr> <tr> <td>2</td> <td>Timer limit</td> <td>When the current timer value reaches the timer limit, the timer will perform one of the following operations according to the type of operation: 1) If the type of operation is One-shot (0), sets the time-up flag to 1, resets the current timer value to 0, and stops itself. 2) If the type of operation is Square-wave (1), toggles the time-up flag, resets the current timer value to 0, and continues the timing operation.</td> </tr> <tr> <td>3</td> <td>Time-up flag</td> <td>This word will be set to 0 or 1 when the current timer value is equal to the timer limit.</td> </tr> </tbody> </table> <p>The timer will use the associated Timer Control Block as its private memory, so do not use any words in the block for other purposes. A Timer Control Block requires 4 words.</p>			Word No.	Data Item	Description	0	Type of operation	0: One-shot; 1: Square-wave	1	Current timer value	The timer increases the value of this word by 1 every 100ms.	2	Timer limit	When the current timer value reaches the timer limit, the timer will perform one of the following operations according to the type of operation: 1) If the type of operation is One-shot (0), sets the time-up flag to 1, resets the current timer value to 0, and stops itself. 2) If the type of operation is Square-wave (1), toggles the time-up flag, resets the current timer value to 0, and continues the timing operation.	3	Time-up flag	This word will be set to 0 or 1 when the current timer value is equal to the timer limit.
Word No.	Data Item	Description																
0	Type of operation	0: One-shot; 1: Square-wave																
1	Current timer value	The timer increases the value of this word by 1 every 100ms.																
2	Timer limit	When the current timer value reaches the timer limit, the timer will perform one of the following operations according to the type of operation: 1) If the type of operation is One-shot (0), sets the time-up flag to 1, resets the current timer value to 0, and stops itself. 2) If the type of operation is Square-wave (1), toggles the time-up flag, resets the current timer value to 0, and continues the timing operation.																
3	Time-up flag	This word will be set to 0 or 1 when the current timer value is equal to the timer limit.																
Example 1	<pre> \$U100 = 1 /* Type of operation is Square-wave. */ \$U101 = 0 /* Initialize the current timer value to 0. */ \$U102 = 5 /* Timer limit is 0.5 second (5*100ms). */ \$U103 = 0 /* Initialize the time-up flag to 0. */ SET_T(3, \$U100) /* Use timer #3 to generate a 1 Hz square wave on \$U103.0 */ </pre>																	

STOP_T

Format	STOP_T(P1)	Data Type	U
Function	Stops the timer <i>P1</i> .		
<i>P1</i> (C)	The ID of the timer.		
Example 1	STOP_T(1) /* Stop timer #1 */		

WAIT_T

Format	WAIT_T(P1)	Data Type	U
Function	Waits for the time-up of timer <i>P1</i> . The macro command following this one will not be executed until the timer reaches its limit.		
<i>P1</i> (C)	The ID of the timer.		
Example 1	<pre> \$U100 = 0 /* Type of operation is One-shot. */ \$U101 = 0 /* Initialize the current timer value to 0. */ \$U102 = 5 /* Timer limit is 0.5 second (5*100ms). */ \$U103 = 0 /* Initialize the time-up flag to 0. */ SET_T(7, \$U100) /* Starts timer #7 as a 0.5 second timer. */ WAIT_T(7) /* Wait 0.5 second */ </pre>		

14.4.10. Keypad Operation

KB_MCR

Format	KB_MCR(P1)	Data Type	U
Function	Accepts or ignores the character/command currently input by the associated keypad button. This command must be used only in a macro that is run by a keypad button. A keypad button runs the specified macro when it is pressed. You can use this command in a keypad button macro to accept or ignore the current input of that button.		
<i>P1</i> (I/C)	The value or the location that holds the value to determine the acceptance of the keypad button input. If the value is 0, the input will be accepted; Otherwise the input will be ignored.		
Example 1	KB_MCR(1) /* Ignore the current input */		

KPD_TEXT

Format	KPD_TEXT(P1)	Data Type	U
Function	The memory block (or byte array) that contains the null-terminated ASCII character string to be used to initialize the keypad display and buffer.		
<i>P1</i> (I)	The memory block (or byte array) that contains the null-terminated ASCII character string to be used to initialize the keypad display and buffer.		
Example 1	<pre> \$U100 = "initial text" KPD_TEXT(\$U100) /* Initialize the keypad display and buffer using the string "initial text". */ </pre>		

14.4.11. Recipe Operation

RB2ROM

Format	<i>P1</i> = RB2ROM(<i>P2</i>)	Data Type	U
Function	Saves the data of recipe block <i>P2</i> to the flash ROM and saves the completion code in <i>P1</i> .		
<i>P1</i> (I)	The word to receive the completion code. If the completion code is 0, the operation succeeded; otherwise the operation failed.		
<i>P2</i> (I/C)	The ID of the recipe block to be saved. The option "Need space in flash ROM to save backup" must be selected for the recipe block.		
Example 1	\$U10 = RB2ROM(3) /* Save recipe block #3 to the flash ROM. */		

ROM2RB

Format	<i>P1</i> = ROM2RB(<i>P2</i>)	Data Type	U
Function	Restores the data of recipe block <i>P2</i> from the flash ROM and saves the completion code in <i>P1</i> .		
<i>P1</i> (I)	The word to receive the completion code. If the completion code is 0, the operation succeeded; otherwise the operation failed.		
<i>P2</i> (I/C)	The ID of the recipe block to be restored. The option "Need space in flash ROM to save backup" must be selected for the recipe block.		
Example 1	\$U10 = ROM2RB(3) /* Restore recipe block #3 from the flash ROM. */		

REF_RCP_OBJ

Format	REF_RCP_OBJ(<i>P1</i>)	Data Type	U
Function	Refreshes the recipe objects associated with the specified recipe block <i>P1</i> . The recipe objects include recipe selectors and recipe tables. You can use this command to update the display of associated objects after changing the data of a recipe block in a macro program.		
<i>P1</i> (I/C)	The ID of the associated recipe block.		
Example 1	REF_RCP_OBJ(3) /* Refresh the recipe objects associated with recipe block #3 */		

14.4.12. Communication Operation

EN_LINK

Format	EN_LINK(<i>P1,P2,P3</i>)	Data Type	U
Function	Enables communication link <i>P1</i> or sub-link <i>P2</i> of communication link <i>P1</i> when <i>P3</i> is 1. Disables the specified communication link or sub-link when <i>P3</i> is 0.		
<i>P1</i> (I/C)	The number of the communication link to be enabled or disabled.		
<i>P2</i> (I/C)	The node address of the sub-link to be enabled or disabled. If the specified communication link has no sub-link, this parameter is ignored. If the specified communication link has sub-links and you want to enable or disable the link itself, set this parameter to 0.		
<i>P3</i> (I/C)	To enable the specified communication link or sub-link, set this parameter to 1. To disable the specified communication link or sub-link, set this parameter to 0.		
Example 1	ENABLE_LINK(1, 20, 0) /* Disable the sub-link, whose node address is 20, of communication link 1. */		

LINK_STS

Format	<i>P1</i> = LINK_STS(<i>P2,P3</i>)	Data Type	U
Function	Gets the status of communication link <i>P2</i> or sub-link <i>P3</i> of communication link <i>P2</i> and saves the result in <i>P1</i> .		
<i>P1</i> (I/C)	The word to receive the status of the specified communication link or sub-link. The status is a 16-bit value. The following table lists the meaning of each status value.		
	Status Value	Meaning	Status Value
	0	OK	14
	1	Overrun error	15
	2	Break error	16
	3	Parity error	17
	4	Framing error	18
	5	No response	19
	6	Unrecognized response	20
	7	Timeout	21
	8	Inactive CTS	22
	9	Checksum error	23
	10	Command rejected	24
	11	Invalid address	255
12	Invalid range	65535	
13	Invalid request		
<i>P2</i> (I/C)	The number of the communication link.		
<i>P3</i> (I/C)	The node address of the sub-link. If the specified communication link has no sub-link, this parameter is ignored.		
Example 1	\$U100 = LINK_STS(2, 0) /* Get the status of communication link 2 and save it to \$U100. */		
Example 2	\$U12 = LINK_STS(1, 128) /* Get the status of the sub-link, whose node address is 128, of communication link 1 and save it to \$U12. */		

14.4.13. System Service

GET_RTC

Format	GET_RTC(<i>P1</i>)	Data Type	U																											
Function	Gets the data of the real time clock and saves the result in <i>P1</i> .																													
<i>P1</i> (I)	<p>The starting location of the memory block that is used as an RTC data block to receive the operation result. The structure of the RTC data block is shown below:</p> <table border="1"> <thead> <tr> <th>Data Item</th> <th>Data Type/Size</th> <th>Word No.</th> </tr> </thead> <tbody> <tr> <td>Second</td> <td>16-bit Unsigned Integer</td> <td>0</td> </tr> <tr> <td>Minute</td> <td>16-bit Unsigned Integer</td> <td>1</td> </tr> <tr> <td>Hour</td> <td>16-bit Unsigned Integer</td> <td>2</td> </tr> <tr> <td>RTC adjustment</td> <td>16-bit Signed Integer</td> <td>3</td> </tr> <tr> <td>Day</td> <td>16-bit Unsigned Integer</td> <td>4</td> </tr> <tr> <td>Month</td> <td>16-bit Unsigned Integer</td> <td>5</td> </tr> <tr> <td>Year</td> <td>16-bit Unsigned Integer</td> <td>6</td> </tr> <tr> <td>Day of week</td> <td>16-bit Unsigned Integer</td> <td>7</td> </tr> </tbody> </table> <p>Second: 0-59; Minute: 0-59; Hour: 0-23; RTC adjustment: -63-63; Day: 1-31; Month: 1-12; Year: 0(2000)-99(2099); Day of week: 0(Sunday)-6(Saturday) An RTC data block requires 8 words.</p>			Data Item	Data Type/Size	Word No.	Second	16-bit Unsigned Integer	0	Minute	16-bit Unsigned Integer	1	Hour	16-bit Unsigned Integer	2	RTC adjustment	16-bit Signed Integer	3	Day	16-bit Unsigned Integer	4	Month	16-bit Unsigned Integer	5	Year	16-bit Unsigned Integer	6	Day of week	16-bit Unsigned Integer	7
Data Item	Data Type/Size	Word No.																												
Second	16-bit Unsigned Integer	0																												
Minute	16-bit Unsigned Integer	1																												
Hour	16-bit Unsigned Integer	2																												
RTC adjustment	16-bit Signed Integer	3																												
Day	16-bit Unsigned Integer	4																												
Month	16-bit Unsigned Integer	5																												
Year	16-bit Unsigned Integer	6																												
Day of week	16-bit Unsigned Integer	7																												
Example 1	GET_RTC(\$U100) /* Get the data of the real time clock. The second will be in \$U100 and the day-of-week will be in \$U107. */																													

SET_RTC

Format	SET_RTC(<i>P1</i>)	Data Type	U
Function	Sets the real time clock using the data in <i>P1</i> .		
<i>P1</i> (I)	The starting location of the memory block that is used as an RTC data block to contain the new settings for the real time clock. See the description of GET_RTC to know the structure of the RTC data block.		
Example 1	<pre>\$U100 = 0 // Second \$U101 = 30 // Minute \$U102 = 8 // Hour \$U103 = 0 // Adjustment \$U104 = 1 // Day \$U105 = 7 // July \$U106 = 10 // Year 2010 \$U107 = 4 // Thursday SET_RTC(\$U100) /* Set the real time clock to 8:30:00 July 1st 2010 Thursday */</pre>		

SYS

Format	SYS(<i>P1,P2,P3</i>)	Data Type	U
Function	Requests system service <i>P1</i> with the arguments <i>P2</i> and <i>P3</i> . This command is reserved for system use.		
<i>P1</i> (I)	The code of the system service.		
<i>P2,P3</i> (I/C)	The arguments of the system service.		

14.4.14. Screen Operation

OPEN_WS

Format	OPEN_WS <i>P1</i>	Data Type	U
Function	The number of the window screen to be opened. This command will not open the specified screen if it is a normal screen or menu screen. The macro commands following this command will not be executed until the opened window screen is closed. Also, when a screen's Cycle macro is waiting for the closing of the window screen opened by this command, that screen cannot be closed or switched by any means.		
<i>P1</i> (I/C)	The number of the window screen to be opened. If the screen number indicates the normal screen or menu screen, no screen will be opened.		

CLOSE_WS

Format	CLOSE_WS
Function	Closes the window screen that was opened by the macro command OPEN_WS.

14.4.15. File Operation

FILE_IO

Format	$P1 = \text{FILE_IO}(P2, P3)$	Data Type	U																																																													
Function	Performs the file operation specified by P2 and P3 using default filename and saves the completion code in P1 .																																																															
P1 (I)	The word to receive the completion code of the operation. If the completion code is 0, the operation succeeded; otherwise the operation failed.																																																															
P2, P3 (I/C)	P2 specifies the type of file operation. P3 specifies the ID of the data source. The following table describes how to set P2 and P3.																																																															
	<table border="1"> <thead> <tr> <th>File Operation</th> <th>P2</th> <th>P3</th> <th>Default Filename Format</th> </tr> </thead> <tbody> <tr> <td>Save Logged Data (.txt)</td> <td>1</td> <td rowspan="2">Data logger ID (0-15)</td> <td>DL<ID>_<Date>_<Time>.txt</td> </tr> <tr> <td>Save Logged Data (.csv)</td> <td>14</td> <td>DL<ID>_<Date>_<Time>.csv</td> </tr> <tr> <td>Save Logged Alarms (.txt)</td> <td>2</td> <td rowspan="2">0</td> <td>AL_<Date>_<Time>.txt</td> </tr> <tr> <td>Save Logged Alarms (.csv)</td> <td>15</td> <td>AL_<Date>_<Time>.csv</td> </tr> <tr> <td>Save Alarm Counts (.txt)</td> <td>3</td> <td rowspan="2">0</td> <td>AC_<Date>_<Time>.txt</td> </tr> <tr> <td>Save Alarm Counts (.csv)</td> <td>16</td> <td>AC_<Date>_<Time>.csv</td> </tr> <tr> <td>Save Recipe Data (.txt)</td> <td>4</td> <td rowspan="3">Recipe block ID (0-15)</td> <td>RB<ID>.txt</td> </tr> <tr> <td>Save Recipe Data (.csv)</td> <td>17</td> <td>RB<ID>.csv</td> </tr> <tr> <td>Save Recipe Data (.prd)</td> <td>5</td> <td>RB<ID>.prd</td> </tr> <tr> <td>Print Screen to File (256-color .bmp)</td> <td>6</td> <td rowspan="2">Screen number (1-7999)</td> <td>S<ID>_<Date>_<Time>.bmp</td> </tr> <tr> <td>Print Screen to File (64K-color .bmp)</td> <td>7</td> <td>S<ID>_<Date>_<Time>.bmp</td> </tr> <tr> <td>Save Logged Operations (.txt)</td> <td>9</td> <td>0</td> <td>OL_<Date>_<Time>.txt</td> </tr> <tr> <td>Save Logged Operations (.csv)</td> <td>18</td> <td>0</td> <td>OL_<Date>_<Time>.csv</td> </tr> <tr> <td>Save Logged Data (.ldf)</td> <td>10</td> <td>Data logger ID (0-15)</td> <td>DL<ID>_<Date>_<Time>.ldf</td> </tr> <tr> <td>Take Picture (.bmp)</td> <td>12</td> <td rowspan="2">USB camera ID (0-3)</td> <td>CAM<ID>_<Date>_<Time>.bmp</td> </tr> <tr> <td>Take Picture (.jpg)</td> <td>13</td> <td>CAM<ID>_<Date>_<Time>.jpg</td> </tr> </tbody> </table>	File Operation	P2	P3	Default Filename Format	Save Logged Data (.txt)	1	Data logger ID (0-15)	DL<ID>_<Date>_<Time>.txt	Save Logged Data (.csv)	14	DL<ID>_<Date>_<Time>.csv	Save Logged Alarms (.txt)	2	0	AL_<Date>_<Time>.txt	Save Logged Alarms (.csv)	15	AL_<Date>_<Time>.csv	Save Alarm Counts (.txt)	3	0	AC_<Date>_<Time>.txt	Save Alarm Counts (.csv)	16	AC_<Date>_<Time>.csv	Save Recipe Data (.txt)	4	Recipe block ID (0-15)	RB<ID>.txt	Save Recipe Data (.csv)	17	RB<ID>.csv	Save Recipe Data (.prd)	5	RB<ID>.prd	Print Screen to File (256-color .bmp)	6	Screen number (1-7999)	S<ID>_<Date>_<Time>.bmp	Print Screen to File (64K-color .bmp)	7	S<ID>_<Date>_<Time>.bmp	Save Logged Operations (.txt)	9	0	OL_<Date>_<Time>.txt	Save Logged Operations (.csv)	18	0	OL_<Date>_<Time>.csv	Save Logged Data (.ldf)	10	Data logger ID (0-15)	DL<ID>_<Date>_<Time>.ldf	Take Picture (.bmp)	12	USB camera ID (0-3)	CAM<ID>_<Date>_<Time>.bmp	Take Picture (.jpg)	13	CAM<ID>_<Date>_<Time>.jpg		
File Operation	P2	P3	Default Filename Format																																																													
Save Logged Data (.txt)	1	Data logger ID (0-15)	DL<ID>_<Date>_<Time>.txt																																																													
Save Logged Data (.csv)	14		DL<ID>_<Date>_<Time>.csv																																																													
Save Logged Alarms (.txt)	2	0	AL_<Date>_<Time>.txt																																																													
Save Logged Alarms (.csv)	15		AL_<Date>_<Time>.csv																																																													
Save Alarm Counts (.txt)	3	0	AC_<Date>_<Time>.txt																																																													
Save Alarm Counts (.csv)	16		AC_<Date>_<Time>.csv																																																													
Save Recipe Data (.txt)	4	Recipe block ID (0-15)	RB<ID>.txt																																																													
Save Recipe Data (.csv)	17		RB<ID>.csv																																																													
Save Recipe Data (.prd)	5		RB<ID>.prd																																																													
Print Screen to File (256-color .bmp)	6	Screen number (1-7999)	S<ID>_<Date>_<Time>.bmp																																																													
Print Screen to File (64K-color .bmp)	7		S<ID>_<Date>_<Time>.bmp																																																													
Save Logged Operations (.txt)	9	0	OL_<Date>_<Time>.txt																																																													
Save Logged Operations (.csv)	18	0	OL_<Date>_<Time>.csv																																																													
Save Logged Data (.ldf)	10	Data logger ID (0-15)	DL<ID>_<Date>_<Time>.ldf																																																													
Take Picture (.bmp)	12	USB camera ID (0-3)	CAM<ID>_<Date>_<Time>.bmp																																																													
Take Picture (.jpg)	13		CAM<ID>_<Date>_<Time>.jpg																																																													
	<p>Note:</p> <p><ID>: ID of the data logger, ID of the recipe block, ID of the USB camera, or number of the screen <Date>: The date when saving the data. <Time>: The time when saving the data. You can select the formats of <Date> and <Time> on the Custom page in the General Setup dialog box.</p>																																																															

FILE_IO_N

Format	<i>P1</i> = FILE_IO_N(<i>P2,P3,P4</i>)	Data Type	U																																				
Function	Performs the file operation specified by <i>P2</i> and <i>P3</i> using filename <i>P4</i> and saves the completion code in <i>P1</i> .																																						
<i>P1</i> (I)	The word to receive the completion code of the operation. If the completion code is 0, the operation succeeded; otherwise the operation failed.																																						
<i>P2,P3</i> (I/C)	<p><i>P2</i> specifies the type of file operation. <i>P3</i> specifies the ID of the data source. The following table describes how to set <i>P2</i> and <i>P3</i>.</p> <table border="1"> <thead> <tr> <th>File Operation</th> <th><i>P2</i></th> <th><i>P3</i></th> </tr> </thead> <tbody> <tr> <td>Save Logged Data (.csv/.txt)</td> <td>31</td> <td>Data logger ID (0-15)</td> </tr> <tr> <td>Save Logged Alarms (.txt)</td> <td>32</td> <td>0</td> </tr> <tr> <td>Save Alarm Counts (.txt)</td> <td>33</td> <td>0</td> </tr> <tr> <td>Save Recipe Data (.csv/.txt)</td> <td>34</td> <td>Recipe block ID (0-15)</td> </tr> <tr> <td>Save Recipe Data (.prd)</td> <td>35</td> <td>Recipe block ID (0-15)</td> </tr> <tr> <td>Print Screen to File (256-color .bmp)</td> <td>36</td> <td>Screen number (1-7999)</td> </tr> <tr> <td>Print Screen to File (64K-color .bmp)</td> <td>37</td> <td>Screen number (1-7999)</td> </tr> <tr> <td>Save Logged Operations (.txt)</td> <td>39</td> <td>0</td> </tr> <tr> <td>Save Logged Data (.ldf)</td> <td>40</td> <td>Data logger ID (0-15)</td> </tr> <tr> <td>Take Picture (.bmp)</td> <td>42</td> <td>USB camera ID (0-3)</td> </tr> <tr> <td>Take Picture (.jpg)</td> <td>43</td> <td>USB camera ID (0-3)</td> </tr> </tbody> </table>			File Operation	<i>P2</i>	<i>P3</i>	Save Logged Data (.csv/.txt)	31	Data logger ID (0-15)	Save Logged Alarms (.txt)	32	0	Save Alarm Counts (.txt)	33	0	Save Recipe Data (.csv/.txt)	34	Recipe block ID (0-15)	Save Recipe Data (.prd)	35	Recipe block ID (0-15)	Print Screen to File (256-color .bmp)	36	Screen number (1-7999)	Print Screen to File (64K-color .bmp)	37	Screen number (1-7999)	Save Logged Operations (.txt)	39	0	Save Logged Data (.ldf)	40	Data logger ID (0-15)	Take Picture (.bmp)	42	USB camera ID (0-3)	Take Picture (.jpg)	43	USB camera ID (0-3)
File Operation	<i>P2</i>	<i>P3</i>																																					
Save Logged Data (.csv/.txt)	31	Data logger ID (0-15)																																					
Save Logged Alarms (.txt)	32	0																																					
Save Alarm Counts (.txt)	33	0																																					
Save Recipe Data (.csv/.txt)	34	Recipe block ID (0-15)																																					
Save Recipe Data (.prd)	35	Recipe block ID (0-15)																																					
Print Screen to File (256-color .bmp)	36	Screen number (1-7999)																																					
Print Screen to File (64K-color .bmp)	37	Screen number (1-7999)																																					
Save Logged Operations (.txt)	39	0																																					
Save Logged Data (.ldf)	40	Data logger ID (0-15)																																					
Take Picture (.bmp)	42	USB camera ID (0-3)																																					
Take Picture (.jpg)	43	USB camera ID (0-3)																																					
<i>P4</i> (I)	The byte array that contains the specified filename or full pathname. The name must be a valid Windows pathname with ASCII characters only. The character string must be null terminated and each character occupies one byte. The maximum length of the string is 127. All the folders stated in the full pathname must already exist or the file operation will fail.																																						

MKDIR

Format	<i>P1</i> = MKDIR(<i>P2</i>)
Function	Creates a new directory with the specified name <i>P2</i> and saves the result to <i>P1</i> .
<i>P1</i> (I)	The word to receive the completion code of the operation. If the completion code is 0, the operation succeeded; otherwise the operation failed.
<i>P2</i> (I)	The byte array that contains the name of the new directory. The name must be a valid directory name with or without pathname and has only ASCII characters in it.

OPEN_FILE

Format	$P1 = \text{OPEN_FILE}(P2, P3)$	Data Type	U												
Function	Creates or opens a file.														
$P1$ (I)	<p>The starting location of the memory block that is used as a File Information Block to receive the operation result. The structure of the File Information Block is shown below:</p> <table border="1"> <thead> <tr> <th>Data Item</th> <th>Data Type/Size</th> <th>Word No.</th> </tr> </thead> <tbody> <tr> <td>File handle</td> <td>32-bit Unsigned Integer</td> <td>0 and 1</td> </tr> <tr> <td>File size</td> <td>32 bit Unsigned Integer</td> <td>2 and 3</td> </tr> <tr> <td>Filename</td> <td>Byte array with 81 elements</td> <td>4 through 44</td> </tr> </tbody> </table> <p>The file handle is zero if the operation failed. The file size is zero for a newly created file. The filename is a null-terminated character string. The maximum allowable size is 80. It is set when the file is successfully opened. A File Information Block requires 45 words.</p>			Data Item	Data Type/Size	Word No.	File handle	32-bit Unsigned Integer	0 and 1	File size	32 bit Unsigned Integer	2 and 3	Filename	Byte array with 81 elements	4 through 44
Data Item	Data Type/Size	Word No.													
File handle	32-bit Unsigned Integer	0 and 1													
File size	32 bit Unsigned Integer	2 and 3													
Filename	Byte array with 81 elements	4 through 44													
$P2$ (I)	The byte array that contains the filename or the full pathname of the file to be opened. The name is a null-terminated string and has only ASCII characters in it.														
$P3$ (I/C)	<p>Specifies the purpose of opening the file.</p> <table border="1"> <thead> <tr> <th>Purpose</th> <th>Value</th> </tr> </thead> <tbody> <tr> <td>Read</td> <td>0</td> </tr> <tr> <td>Write</td> <td>1</td> </tr> <tr> <td>Append</td> <td>3</td> </tr> <tr> <td>Read CSV File</td> <td>5</td> </tr> </tbody> </table>			Purpose	Value	Read	0	Write	1	Append	3	Read CSV File	5		
Purpose	Value														
Read	0														
Write	1														
Append	3														
Read CSV File	5														
Example 1	<pre><code>\$U10 = "test.txt" \$U100 = OPEN_FILE(\$U10, 0) /* Open the file "test.txt" for the read operation. The double word \$U100 will contain the file handle. The double word \$U102 will contain the file size. The byte array \$U104 will contain the filename. */</code></pre>														

READ_FILE

Format	$P1 = \text{READ_FILE}(P2, P3, P4)$	Data Type	U
Function	Reads $P4$ bytes from file $P2$ to buffer $P3$ and saves the result in $P1$.		
$P1$ (I)	The word to receive the number of bytes that were actually read. If the operation failed, the number is 65535 (0xFFFF).		
$P2$ (I)	The file handle of the file to be read.		
$P3$ (I)	The memory block to receive the data read from the file.		
$P4$ (I/C)	Number of bytes to be read from the file. The maximum you can specify is 32767(0x7FFF).		
Example 1	<pre><code>\$U200 = READ_FILE(\$U100, \$U150, 20) /* Read 20 bytes from the file specified by the file handle in \$U100 and saves the data in the memory block starting from \$U150. */</code></pre>		

WRITE_FILE

Format	<i>P1</i> = WRITE_FILE(<i>P2,P3,P4</i>)	Data Type	U
Function	Writes <i>P4</i> bytes of data in <i>P3</i> to file <i>P2</i> and saves the completion code in <i>P1</i> .		
<i>P1</i> (I)	The word to receive the completion code of the operation. If the completion code is 0, the operation succeeded; otherwise the operation failed.		
<i>P2</i> (I)	The file handle of the file.		
<i>P3</i> (I)	The memory block (or byte array) that stores the data to be written to the file.		
<i>P4</i> (I/C)	Number of bytes to be written to the file.		
Example 1	<code>\$U200=WRITE_FILE(\$U100,\$U150,30) /* Write 30 bytes of data stored in the memory block starting from \$U150 to the file specified by the file handle in \$U100. */</code>		

CLOSE_FILE

Format	<i>P1</i> = CLOSE_FILE(<i>P2,P3</i>)	Data Type	U
Function	Closes an opened file <i>P2</i> and saves the completion code in <i>P1</i> .		
<i>P1</i> (I)	The word to receive the completion code of the operation. If the completion code is 0, the operation succeeded; otherwise the operation failed.		
<i>P2</i> (I)	The file handle of the file to be closed.		
Example 1	<code>\$U200=CLOSE_FILE(\$U100) /* Close the file specified by the file handle in \$U100. */</code>		

DELETE_FILE

Format	<i>P1</i> = DELETE_FILE(<i>P2</i>)	Data Type	U
Function	Deletes a file named <i>P2</i> and saves the completion code in <i>P1</i> .		
<i>P1</i> (I)	The word to receive the completion code of the operation. If the completion code is 0, the operation succeeded; otherwise the operation failed.		
<i>P2</i> (I)	The byte array that contains the filename or the full pathname of the file to be deleted. The name is a null-terminated string and has only ASCII characters in it.		
Example 1	<code>\$U10 = "test.txt" \$U200 = DELETE_FILE(\$U10) /* Delete the file "test.txt". */</code>		

RENAME_FILE

Format	<i>P1</i> = RENAME_FILE(<i>P2,P3</i>)	Data Type	U
Function	Renames file <i>P2</i> with new name <i>P3</i> and saves the completion code in <i>P1</i> .		
<i>P1</i> (I)	The word to receive the completion code of the operation. If the completion code is 0, the operation succeeded; otherwise the operation failed.		
<i>P2</i> (I)	The byte array that contains the filename or the full pathname of the file to be renamed. The name is a null-terminated string and has only ASCII characters in it.		
<i>P3</i> (I)	The byte array that contains the new filename. The name is a null-terminated string and has only ASCII characters in it.		
Example 1	<code>\$U10 = "test.txt" \$U50 = "new.txt" \$U200 = RENAME_FILE(\$U10, \$U50) /* Rename the file "test.txt" to "new.txt". */</code>		

GET_VOL_INFO

Format	$P1 = \text{GET_VOL_INFO}(P2, P3)$	Data Type	U															
Function	Gets the information of volume $P2$ and saves the result in $P3$. The completion code is saved in $P1$.																	
$P1$ (I)	The word to receive the completion code of the operation. If the completion code is 0, the operation succeeded; otherwise the operation failed.																	
$P2$ (I/C)	The drive ID. <table border="1" style="width: 100%; border-collapse: collapse;"> <thead> <tr> <th>ID</th> <th>Drive</th> </tr> </thead> <tbody> <tr> <td>0</td> <td>Current drive</td> </tr> <tr> <td>3</td> <td>Drive C</td> </tr> <tr> <td>4</td> <td>Drive D</td> </tr> <tr> <td>5</td> <td>Drive E</td> </tr> </tbody> </table>			ID	Drive	0	Current drive	3	Drive C	4	Drive D	5	Drive E					
ID	Drive																	
0	Current drive																	
3	Drive C																	
4	Drive D																	
5	Drive E																	
$P3$ (I)	The starting location of the memory block that is used as a Volume Information Block to receive the operation result. The structure of the Volume Information Block is shown below: <table border="1" style="width: 100%; border-collapse: collapse;"> <thead> <tr> <th>Data Item</th> <th>Data Type/Size</th> <th>Word No.</th> </tr> </thead> <tbody> <tr> <td>Volume name</td> <td>Byte array with 32 elements</td> <td>0 through 15</td> </tr> <tr> <td>Volume size</td> <td>32-bit Unsigned Integer</td> <td>16 and 17</td> </tr> <tr> <td>Free size</td> <td>32-bit Unsigned Integer</td> <td>18 and 19</td> </tr> <tr> <td>Drive ID</td> <td>16-bit Unsigned Integer</td> <td>20</td> </tr> </tbody> </table> <p>The volume name is a null-terminated character string. The maximum allowable size is 31 characters. Both the unit of volume size and the unit of free size are 1024 bytes. A Volume Information Block requires 21 words.</p>			Data Item	Data Type/Size	Word No.	Volume name	Byte array with 32 elements	0 through 15	Volume size	32-bit Unsigned Integer	16 and 17	Free size	32-bit Unsigned Integer	18 and 19	Drive ID	16-bit Unsigned Integer	20
Data Item	Data Type/Size	Word No.																
Volume name	Byte array with 32 elements	0 through 15																
Volume size	32-bit Unsigned Integer	16 and 17																
Free size	32-bit Unsigned Integer	18 and 19																
Drive ID	16-bit Unsigned Integer	20																
Example 1	<pre>\$U100 = GET_VOL_INFO(0, \$U0) /* Get the volume information of the current drive. The volume name will be stored in \$U0 through \$U15. The size of the drive will be stored in \$U16 and \$U17. The free size of the drive will be stored in \$U18 and \$U19. The ID of the current drive will be stored in \$U20. */</pre>																	

READ_CSV

Format	$P1 = \text{READ_CSV}(P2, P3, P4)$	Data Type	S/U/SD/UD/F
Function	Reads the data in the field of row $P3$ and column $P4$ of the CSV file $P2$ and saves the result in $P1$.		
$P1$ (I)	The word location to receive the value of the specified field. The data type selected for this command should be the same as the data type of the specified field, or the operation may fail. If the operation fails for any reason, no value will be written to $P1$. To know if the operation failed or not, check the word \$\$S522. When the value of \$\$S522 is non-zero, the operation failed.		
$P2$ (I)	The file handle of the file to be read. The file must be a CSV file and is opened with the purpose of Read CSV File. The delimiter must be TAB.		
$P3$ (I/C)	The row number of the field to be read. The row counts from 0.		
$P4$ (I/C)	The column number of the field to be read. The column counts from 0.		
Example 1	<pre>\$U10 = "test.csv" \$U100 = OPEN_FILE(\$U10,5) /* Open the file "test.csv" for the READ CSV FILE operation. */ \$U200 = READ_CSV(\$U100,2,3) (F) /* Read the floating point number in the field of row 2 and column 3 and save the result in \$U200 and \$U201. */</pre>		

READ_CSV_STR

Format	<i>P1 = READ_CSV_STR (P2,P3,P4)</i>
Function	Reads the string in the field of row <i>P3</i> and column <i>P4</i> of the CSV file <i>P2</i> and saves the result in <i>P1</i> .
<i>P1</i> (I)	The byte array to receive the string in the specified field. The maximal string length that this command can handle is 128. If the operation fails for any reason, no value will be written to <i>P1</i> . To know if the operation failed or not, check the word \$S522. When the value of \$S522 is non-zero, the operation failed.
<i>P2</i> (I)	The file handle of the file to be read. The file must be a CSV file and is opened with the purpose of Read CSV File. The delimiter must be TAB.
<i>P3</i> (I/C)	The row number of the field to be read. The row counts from 0.
<i>P4</i> (I/C)	The column number of the field to be read. The column counts from 0.
Example 1	<pre> \$U10 = "test.csv" \$U100 = OPEN_FILE(\$U10,5) /* Open the file "test.csv" for the READ CSV FILE operation. */ \$U200 = READ_CSV_STR(\$U100,2,4) /* Read the string in the field of row 2 and column 4 and save the result in the byte array starting at \$U200. */ </pre>

14.4.16. Comparison

==

Format	$P1 = P2 == P3$	Data Type	U/S/UD/SD/F/B
Function	Sets bit $P1$ to 1 if $P2$ is equal to $P3$, otherwise sets $P1$ to 0.		
$P1$ (I/E)	The bit location to save the result.		
$P2,P3$ (I/E/C/AE)	The operands.		
Example 1	$\$U3.3 = (\$U10 + \$U20) == 25.75$ (F)		

!=

Format	$P1 = P2 != P3$	Data Type	U/S/UD/SD/F/B
Function	Sets bit $P1$ to 1 if $P2$ is not equal to $P3$, otherwise sets $P1$ to 0.		
$P1$ (I/E)	The bit location to save the result.		
$P2,P3$ (I/E/C/AE)	The operands.		
Example 1	$\$U3.3 = (\$U10 + \$U20) != -700$ (S)		

>

Format	$P1 = P2 > P3$	Data Type	U/S/UD/SD/F
Function	Sets bit $P1$ to 1 if $P2$ is greater than $P3$, otherwise sets $P1$ to 0.		
$P1$ (I/E)	The bit location to save the result.		
$P2,P3$ (I/E/C/AE)	The operands.		
Example 1	$\$U3.3 = (\$U10 + \$U20) > \$U30$ (UD)		

>=

Format	$P1 = P2 >= P3$	Data Type	U/S/UD/SD/F
Function	Sets bit $P1$ to 1 if $P2$ is greater than or equal to $P3$, otherwise sets $P1$ to 0.		
$P1$ (I/E)	The bit location to save the result.		
$P2,P3$ (I/E/C/AE)	The operands.		
Example 1	$\$U3.3 = (\$U10 + \$U20) >= 25.75$ (F)		

<

Format	$P1 = P2 < P3$	Data Type	U/S/UD/SD/F
Function	Sets bit $P1$ to 1 if $P2$ is less than $P3$, otherwise sets $P1$ to 0.		
$P1$ (I/E)	The bit location to save the result.		
$P2,P3$ (I/E/C/AE)	The operands.		
Example 1	$\$U3.3 = (\$U10 + \$U20) < 25.75$ (F)		

<=

Format	$P1 = P2 <= P3$	Data Type	U/S/UD/SD/F
Function	Sets bit $P1$ to 1 if $P2$ is less than or equal to $P3$, otherwise sets $P1$ to 0.		
$P1$ (I/E)	The bit location to save the result.		
$P2,P3$ (I/E/C/AE)	The operands.		
Example 1	$\$U3.3 = (\$U10 + \$U20) <= 25.75$ (F)		

14.4.17. String Operation

STRCPY

Format	STRCPY(<i>P1</i>, <i>P2</i>)												
Function	Copies the string in <i>P2</i> to <i>P1</i> .												
<i>P1</i> (l)	The byte array that receives a copy of the string in <i>P2</i> . The byte array must be large enough to hold the string and the null terminator.												
<i>P2</i> (l)	The source, i.e. the byte array that contains the null-terminated string to be copied.												
Example 1	<p><code>\$U10 = "ABCDE"</code> <code>STRCPY(\$U20, \$U10)</code> After the command STRCPY is executed, the byte array \$U20 contains the string "ABCDE" and the memory content is like the following:</p> <table border="1"> <thead> <tr> <th>Word</th> <th>Low Byte</th> <th>High Byte</th> </tr> </thead> <tbody> <tr> <td>\$U20</td> <td>'A'</td> <td>'B'</td> </tr> <tr> <td>\$U21</td> <td>'C'</td> <td>'D'</td> </tr> <tr> <td>\$U22</td> <td>'E'</td> <td>0</td> </tr> </tbody> </table>	Word	Low Byte	High Byte	\$U20	'A'	'B'	\$U21	'C'	'D'	\$U22	'E'	0
Word	Low Byte	High Byte											
\$U20	'A'	'B'											
\$U21	'C'	'D'											
\$U22	'E'	0											
Example 2	<p><code>\$U10 = "12"</code> <code>STRCPY(\$U20, \$U10)</code> After the command STRCPY is executed, the byte array \$U20 contains the string "12" and the memory content is like the following:</p> <table border="1"> <thead> <tr> <th>Word</th> <th>Low Byte</th> <th>High Byte</th> </tr> </thead> <tbody> <tr> <td>\$U20</td> <td>'1'</td> <td>'2'</td> </tr> <tr> <td>\$U21</td> <td>0</td> <td>Undefined</td> </tr> </tbody> </table>	Word	Low Byte	High Byte	\$U20	'1'	'2'	\$U21	0	Undefined			
Word	Low Byte	High Byte											
\$U20	'1'	'2'											
\$U21	0	Undefined											

STRCAT

Format	STRCAT(<i>P1</i>, <i>P2</i>)
Function	Appends string in <i>P2</i> to string in <i>P1</i> .
<i>P1</i> (l)	The byte array that contains a null-terminated string to which the command appends <i>P2</i> . The byte array must be large enough to hold both strings and the null terminator.
<i>P2</i> (l)	The byte array that contains a null-terminated string to be appended to the string in <i>P1</i> .
Example 1	<p><code>\$U10 = "ABC"</code> <code>\$U20 = "12345"</code> <code>STRCAT(\$U10, \$U20) /* After this command is executed, the byte array \$U10 contains "ABC12345" */</code></p>
Example 2	<p><code>\$U100 = "C:\MyFolder\"</code> <code>\$U130 = "Test"</code> <code>\$U140 = ".txt"</code> <code>STRCAT(\$U100, \$U130)</code> <code>STRCAT(\$U100, \$U140) /* After this command is executed, the byte array \$U100 contains "C:\MyFolder\Test.txt" */</code></p>

STRLEN

Format	$P1 = \text{STRLEN}(P2)$
Function	Gets the length of string $P2$ and saves the result in $P1$.
$P1$ (l)	The word to receive the result.
$P2$ (l)	The byte array that stores the null-terminated string.
Example 1	<code>\$U10 = "ABC"</code> <code>\$U20 = STRLEN(\$U10) /* After this command is executed, the value of \$U20 is 3. */</code>

STRCMP

Format	$P1 = \text{STRCMP}(P2,P3)$	
Function	Compares strings $P2$ and $P3$ lexicographically and saves a value indicating their relationship in $P1$.	
$P1$ (l)	The value of comparison result.	
	Value	Description
	0	$P2$ and $P3$ are identical.
	1	$P2$ is greater than $P3$.
	0xFFFF	$P2$ is less than $P3$.
$P2,P3$ (l)	The byte array that contains a null-terminated string to compare.	
Example 1	<code>\$U10 = "ABC"</code> <code>\$U20 = "abc"</code> <code>\$U30 = STRCMP(\$U10, \$U20) /* After this command is executed, \$U30 is 0xFFFF*/</code>	
Example 2	<code>\$U10 = "XYZ"</code> <code>\$U20 = "ABC"</code> <code>\$U30 = STRCMP(\$U10, \$U20) /* After this command is executed, \$U30 is 1*/</code>	
Example 3	<code>\$U10 = "ABC"</code> <code>\$U20 = "ABC"</code> <code>\$U30 = STRCMP(\$U10, \$U20) /* After this command is executed, \$U30 is 0*/</code>	

STRICMP

Format	<i>P1</i> = STRICMP(<i>P2</i>,<i>P3</i>)	
Function	Compares lowercase version of strings <i>P2</i> and <i>P3</i> lexicographically and saves a value indicating their relationship in <i>P1</i> .	
<i>P1</i> (l)	The value of comparison result.	
	Value	Description
	0	<i>P2</i> and <i>P3</i> are identical.
	1	<i>P2</i> is greater than <i>P3</i> .
	0xFFFF	<i>P2</i> is less than <i>P3</i> .
<i>P2,P3</i> (l)	The byte array that contains a null-terminated string to compare.	
Example 1	<pre> \$U10 = "ABC" \$U20 = "abc" \$U30 = STRICMP(\$U10, \$U20) /* After this command is executed, \$U30 is 0*/ </pre>	
Example 2	<pre> \$U10 = "XYZ" \$U20 = "ABC" \$U30 = STRICMP(\$U10, \$U20) /* After this command is executed, \$U30 is 1*/ </pre>	
Example 3	<pre> \$U10 = "ABC" \$U20 = "ABC" \$U30 = STRCMP(\$U10, \$U20) /* After this command is executed, \$U30 is 0xFFFF*/ </pre>	

STRNCMP

Format	$P1 = \text{STRNCMP}(P2, P3, P4)$								
Function	Lexicographically compares, at most, the first $P4$ characters in strings $P2$ and $P3$ and saves a value indicating the relationship between the substrings in $P1$.								
$P1$ (I)	The value of comparison result. <table border="1"> <thead> <tr> <th>Value</th> <th>Description</th> </tr> </thead> <tbody> <tr> <td>0</td> <td>$P2$'s substring and $P3$'s substring are identical</td> </tr> <tr> <td>1</td> <td>$P2$'s substring is greater than $P3$'s substring .</td> </tr> <tr> <td>0xFFFF</td> <td>$P2$'s substring is less than $P3$'s substring .</td> </tr> </tbody> </table> <p>Note: The comparison ends if a terminating null character is reached in either string before $P4$ characters are compared. If the strings are equal when a terminating null character is reached in either string before $P4$ characters are compared, the shorter string is less. The characters from 91 to 96 in the ASCII table ('[, '\, ']', '^', '_ ', and '^') will evaluate as less than any alphabetic character.</p>	Value	Description	0	$P2$'s substring and $P3$'s substring are identical	1	$P2$'s substring is greater than $P3$'s substring .	0xFFFF	$P2$'s substring is less than $P3$'s substring .
Value	Description								
0	$P2$'s substring and $P3$'s substring are identical								
1	$P2$'s substring is greater than $P3$'s substring .								
0xFFFF	$P2$'s substring is less than $P3$'s substring .								
$P2, P3$ (I)	The byte array that contains a null-terminated string to compare.								
$P4$ (I/C)	The number of characters to compare.								
Example 1	<pre>\$U10 = "XYZ" \$U20 = "XYZAB" \$U30 = STRNCMP(\$U10, \$U20, 4) /* After this command is executed, \$U30 is 0xFFFF*/</pre>								
Example 2	<pre>\$U10 = "ABZ" \$U20 = "ABC" \$U30 = STRNCMP(\$U10, \$U20, 2) /* After this command is executed, \$U30 is 0*/</pre>								
Example 3	<pre>\$U10 = "AXC" \$U20 = "ABC" \$U30 = STRNCMP(\$U10, \$U20, 3) /* After this command is executed, \$U30 is 1*/ \$U30 = STRCMP(\$U10, \$U20) /* After this command is executed, \$U30 is 0xFFFF*/</pre>								

STRCHR

Format	$P1 = \text{STRCHR}(P2, P3)$
Function	Finds the first occurrence of a character $P3$ in a string $P2$ and saves a search result in value indicating the position of the found character in $P1$.
$P1$ (I)	The value of search result. If the character $P3$ is not found in $P2$, the result value is 0xFFFF. Otherwise, the result value is the index to the first occurrence of character $P3$ in a string $P2$.
$P2$ (I)	The byte array that contains a null-terminated source string.
$P3$ (I/C)	The byte that contains a character code to be located.
Example 1	<pre>\$U10 = "The quick brown dog jumps over the lazy fox." \$U20 = 0x72 /* The ASCII code of character 'r' */ \$U30 = STRCHR(\$U10, \$U20) /* After this command is executed, \$U30 is 11*/</pre>

NUM2STR

Format	P1 = NUM2STR(P2,P3)	Data Type	U/UD
Function	Converts the number in P2 to a string with P3 characters and saves the result in P1 .		
P1 (I)	The byte array that stores the result.		
P2 (I/C)	The number or the location that holds the number to be converted.		
P3 (I/C)	Specifies the exact number of characters that the result should have. If the number of digits of P2 is less than P3 , the result is padded on the left with zeros. If the number of digits of P2 exceeds P3 , the higher digits are truncated. If P3 is 0, there is no limitation on the length of the result.		
Example 1	<pre>\$U120 = 123 \$U100 = NUM2STR(\$U120, 0) (U) /* After this command is executed, the byte array \$U100 contains "123". */</pre>		
Example 2	<pre>\$U120 = 1234567 (UD) \$U100 = NUM2STR(\$U120, 10) (UD) /* After this command is executed, the byte array \$U100 contains "0001234567". */</pre>		
Example 3	<pre>\$U120 = 1234567 (UD) \$U100 = NUM2STR(\$U120, 5) (UD) /* After this command is executed, the byte array \$U100 contains "34567". */</pre>		

TIME2STR

Format	P1 = TIME2STR(P2)	Data Type	U									
Function	Converts the current system time to a string using the format specified by P2 and saves the result in P1 .											
P1 (I)	The byte array that stores the result.											
P2 (I/C)	Specifies the desired conversion format.											
	<table border="1"> <thead> <tr> <th>Format</th> <th>P2 Value</th> <th>Remark</th> </tr> </thead> <tbody> <tr> <td>hhmmss</td> <td>0</td> <td>hh: hour(00-23); mm: minute(00-59); ss: second(00-59)</td> </tr> <tr> <td>hhmm</td> <td>1</td> <td>hh, mm: same as above</td> </tr> </tbody> </table>	Format	P2 Value	Remark	hhmmss	0	hh: hour(00-23); mm: minute(00-59); ss: second(00-59)	hhmm	1	hh, mm: same as above		
Format	P2 Value	Remark										
hhmmss	0	hh: hour(00-23); mm: minute(00-59); ss: second(00-59)										
hhmm	1	hh, mm: same as above										
Example 1	<pre>\$U10 = TIME2STR(0) /* Assume that the current system time is 12:30:59. After this command is executed, the byte array \$U10 contains "123059". */</pre>											

DATE2STR

Format	P1 = DATE2STR(P2)	Data Type	U															
Function	Converts the current system date to a string using the format specified by P2 and saves the result in P1 .																	
P1 (I)	The byte array that stores the result.																	
P2 (I/C)	Specifies the desired conversion format.																	
	<table border="1"> <thead> <tr> <th>Format</th> <th>P2 Value</th> <th>Remark</th> </tr> </thead> <tbody> <tr> <td>YYMMDD</td> <td>0</td> <td>YY: year (00-99); MM: month(01-12); DD: day(01-31)</td> </tr> <tr> <td>YYMM</td> <td>1</td> <td>YY, MM: same as above</td> </tr> <tr> <td>YYMMMDD</td> <td>2</td> <td>YY: year (00-99); MMM: month(JAN-DEC); DD: day(01-31)</td> </tr> <tr> <td>YYMMM</td> <td>3</td> <td>YY, MMM: same as above</td> </tr> </tbody> </table>	Format	P2 Value	Remark	YYMMDD	0	YY: year (00-99); MM: month(01-12); DD: day(01-31)	YYMM	1	YY, MM: same as above	YYMMMDD	2	YY: year (00-99); MMM: month(JAN-DEC); DD: day(01-31)	YYMMM	3	YY, MMM: same as above		
Format	P2 Value	Remark																
YYMMDD	0	YY: year (00-99); MM: month(01-12); DD: day(01-31)																
YYMM	1	YY, MM: same as above																
YYMMMDD	2	YY: year (00-99); MMM: month(JAN-DEC); DD: day(01-31)																
YYMMM	3	YY, MMM: same as above																
Example 1	<pre>\$U10 = DATE2STR(0) /* Assume that the current system date is December 7, 2008. After this command is executed, the byte array \$U10 contains "081207". */</pre>																	
Example 2	<pre>\$U20 = DATE2STR(3) /* Assume that the current system date is December 31, 2008. After this command is executed, the byte array \$U20 contains "08DEC". */</pre>																	

TD2STR

Format	$P1 = \text{TD2STR}(P2)$	Data Type	U
Function	Converts the current system time and date to a string using the format specified by $P2$ and saves the result in $P1$.		
$P1$ (I)	The byte array that stores the result.		
$P2$ (I/C)	Specifies the desired conversion format.		
	Format	$P2$ Value	Remark
	YYMMDD_hhmmss	0	YY: year (00-99); MM: month(01-12); DD: day(01-31) hh: hour(00-23); mm: minute(00-59) ; ss: second(00-59)
	YYMMMDD_hhmmss	1	YY, DD, hh, mm, ss: same as above MMM: month(JAN-DEC)
	YYMMDD_hhmm	2	YY, DD, hh, mm: same as above; MM: month(01-12)
	YYMMMDD_hhmm	3	YY, DD, hh, mm: same as above; MMM: month(JAN-DEC)
Example 1	$\$U10 = \text{TD2STR}(0)$ /* Assume that the current system date is December 7, 2008 and the current system time is 15:18:30. After this command is executed, the byte array \$U10 contains "081207_151830". */		
Example 2	$\$U20 = \text{TD2STR}(3)$ /* Assume that the current system date is December 31, 2008 and the current system time is 13:30:00. After this command is executed, the byte array \$U20 contains "08DEC31_1330". */		

I2A

Format	$P1 = \text{I2A}(P2,P3)$	Data Type	U/S/UD/SD
Function	Converts the integer number in $P2$ to a string and saves the result in $P1$. The string is generated according to the format specified by $P3$ and $P4$.		
$P1$ (I)	The byte array that stores the result. The result is a null terminated string.		
$P2$ (I/C)	The integer number or the location that holds the integer number to be converted.		
$P3$ (I/C)	Specifies the maximum number of digits the string can have.		
$P4$ (I/C)	Specifies where to insert a decimal point in the string. A decimal point is inserted to the left of the nth digit when $P4$ is n. No decimal point is inserted when $P4$ is 0.		
Example 1	$\$U120 = 123$ $\$U100 = \text{I2A}(\$U120, 5, 0)$ /* After this command is executed, the byte array \$U100 contains "123". */		
Example 2	$\$U120 = 1234567$ (UD) $\$U100 = \text{I2A}(\$U120, 6, 2)$ (UD) /* After this command is executed, the byte array \$U100 contains "2345.67". */		
Example 3	$\$U120 = -12345$ (S) $\$U100 = \text{I2A}(\$U120, 5, 1)$ (UD) /* After this command is executed, the byte array \$U100 contains "-1234.5". */		

A2I

Format	$P1 = A2I(P2, P3, P4)$	Data Type	U/S/UD/SD
Function	Converts the string $P2$ to an integer value and saves the result in $P1$.		
$P1$ (I)	The location that stores the result. The result is 0 when there is any conversion error.		
$P2$ (I)	The byte array that holds the string to be converted.		
$P3$ (I/C)	Specifies the length of the string. It is allowed to specify 0 for $P3$. When $P3$ is 0, the string must be a null terminated string.		
$P4$ (I/C)	Specifies how many fractional digits in the string are to be converted.		
Example 1	$\$U120 = "123"$ $\$U100 = A2I(\$U120, 0, 0)$ /* After this command is executed, the value in word $\$U100$ is 123. */		
Example 2	$\$U120 = "1234567"$ $\$U100 = A2I(\$U120, 6, 0)$ (UD) /* After this command is executed, the value in double word $\$U100$ is 123456. */		
Example 3	$\$U120 = "-123.45"$ $\$U100 = A2I(\$U120, 0, 2)$ (S) /* After this command is executed, the value in word $\$U100$ is -12345. */		

F2A

Format	$P1 = F2A(P2, P3)$	Data Type	F
Function	Converts the floating point number in $P2$ to a string and saves the result in $P1$. The string is generated according to the format specified by $P3$ and $P4$.		
$P1$ (I)	The byte array that stores the result. The result is a null terminated string.		
$P2$ (I/C)	The floating point number or the location that holds the floating point number to be converted.		
$P3$ (I/C)	Specifies the number of integral digits the string can have.		
$P4$ (I/C)	Specifies the number of fractional digits the string can have.		
Example 1	$\$U120 = 123.45$ (F) $\$U100 = F2A(\$U120, 5, 2)$ /* After this command is executed, the byte array $\$U100$ contains "123.45". */		
Example 2	$\$U120 = 1234$ (F) $\$U100 = F2A(\$U120, 6, 2)$ (UD) /* After this command is executed, the byte array $\$U100$ contains "1234.00". */		
Example 3	$\$U120 = -1234.5$ (S) $\$U100 = F2A(\$U120, 5, 1)$ (UD) /* After this command is executed, the byte array $\$U100$ contains "-1234.5". */		

A2F

Format	$P1 = A2F(P2, P3)$	Data Type	F
Function	Converts the string $P2$ to a floating point number and saves the result in $P1$.		
$P1$ (l)	The location that stores the result. The result is 0 when there is any conversion error.		
$P2$ (l)	The byte array that holds the string to be converted.		
$P3$ (l/C)	Specifies the length of the string. It is allowed to specify 0 for $P3$. When $P3$ is 0, the string must be a null terminated string.		
Example 1	$\$U120 = "123.4"$ $\$U100 = A2F(\$U120, 0) /*The value of the floating point number in double word $U100 is 123.4. */$		
Example 2	$\$U120 = "1234567"$ $\$U100 = A2F(\$U120, 6) (UD) /* The value of the floating point number in double word $U100 is 123456. */$		
Example 3	$\$U120 = "-123.45"$ $\$U100 = A2F(\$U120, 0) (S) /* The value of the floating point number in double word $U100 is -123.45. */$		

14.4.18. Run Operation

RUN

Format	RUN(P1)
Function	Runs the executable P1 which is on the same PC. This command is only available for the runtime software on the PC.
P1 (I/A)	The name of the executable to be run.
Example 1	RUN "ABC.exe" /* Run the program ABC */
Example 2	\$U10 = "XYZ.bat" RUN \$U10 /* Run the batch file XYZ */

RUNW

Format	P1 = RUNW(P2)
Function	Runs the executable P2 which is on the same PC and saves the result in P1 . Note that the macro command following this one will not be executed until the program is closed. This command is only available for the runtime software on the PC.
P1 (I)	The word to receive the result.
P2 (I/A)	The name of the executable to be run.
Example 1	\$U10 = RUNW "ABC.exe" /* Run the program ABC and use \$U10 to get the result. */ IF \$U10 == 0 /* If the result is 0 then run the batch file XYZ. */ \$U20 = "XYZ.bat" \$U11 = RUNW \$U20 /* Run the batch file XYZ. */ ENDIF

14.4.19. Print Operation

PRINT

Format	<i>P1</i> = PRINT(<i>P2</i> , <i>P3</i>)	Data Type	U												
Function	Sends <i>P3</i> bytes of data stored in byte array <i>P2</i> to the printer and saves the completion code in <i>P1</i> .														
<i>P1</i> (I)	<p>The word to receive the completion code of the operation. The following table describes the meanings of the completion codes.</p> <table border="1"> <thead> <tr> <th>Code</th> <th>Description</th> </tr> </thead> <tbody> <tr> <td>0</td> <td>Succeeded</td> </tr> <tr> <td>1</td> <td>Printer not ready</td> </tr> <tr> <td>3</td> <td>System error</td> </tr> <tr> <td>4</td> <td>Printer busy</td> </tr> <tr> <td>7</td> <td>No printer specified</td> </tr> </tbody> </table>			Code	Description	0	Succeeded	1	Printer not ready	3	System error	4	Printer busy	7	No printer specified
Code	Description														
0	Succeeded														
1	Printer not ready														
3	System error														
4	Printer busy														
7	No printer specified														
<i>P2</i> (I)	The starting location of the byte array that stores the data to be sent to the printer.														
<i>P3</i> (I/C)	The length in byte of the data to be sent to the printer.														
Example 1	<pre> \$U10 = "This is a test." \$U20 = PRINT(\$U10, 15) /* Send the string "This is a test." to the printer. */ \$U10 = 10 \$U20 = PRINT(\$U10, 1) /* Send the line-feed character to the printer */ \$U10 = 12 \$U20 = PRINT(\$U10, 1) /* Send the form-feed character to the printer */ </pre>														
Example 2	<pre> \$U10 = 0x401b /* ESC, '@' */ \$U20 = PRINT(\$U10, 2) /* Send the initialization command to the EPSON printer */ </pre>														

PRINT_SCREEN

Format	<i>P1</i> = PRINT_SCREEN(<i>P2</i> , <i>P3</i>)	Data Type	U																		
Function	Prints screen <i>P2</i> and saves the result in <i>P1</i> .																				
<i>P1</i> (I)	<p>The word to receive the completion code of the operation. The following table describes the meanings of the completion codes.</p> <table border="1"> <thead> <tr> <th>Code</th> <th>Description</th> </tr> </thead> <tbody> <tr> <td>0</td> <td>Succeeded</td> </tr> <tr> <td>1</td> <td>Printer not ready</td> </tr> <tr> <td>2</td> <td>Invalid screen number</td> </tr> <tr> <td>3</td> <td>System error</td> </tr> <tr> <td>4</td> <td>Printer busy</td> </tr> <tr> <td>5</td> <td>System busy</td> </tr> <tr> <td>6</td> <td>Improper use of this command (See Note)</td> </tr> <tr> <td>7</td> <td>No printer specified</td> </tr> </tbody> </table> <p>Note: This command can only be used in the following types of macros: Main Macro, Event Macro, Time Macro, and Cycle Macro.</p>			Code	Description	0	Succeeded	1	Printer not ready	2	Invalid screen number	3	System error	4	Printer busy	5	System busy	6	Improper use of this command (See Note)	7	No printer specified
Code	Description																				
0	Succeeded																				
1	Printer not ready																				
2	Invalid screen number																				
3	System error																				
4	Printer busy																				
5	System busy																				
6	Improper use of this command (See Note)																				
7	No printer specified																				
<i>P2</i> (I/C)	The number of the screen to be printed. The printed area is specified in the Screen Properties dialog box.																				
<i>P3</i> (I/C)	Reserved for future use. Must be 0.																				
Example 1	<pre> \$U0 = PRINT_SCREEN(28, 0) /* Print screen #28*/ </pre>																				

BLANK

Format	<i>P1</i> = BLANK (<i>P2</i>)	Data Type	U
Function	Blanks the print buffer <i>P1</i> , i.e. makes the print buffer <i>P1</i> contain only blank characters.		
<i>P1</i> (l)	The print buffer to be blanked. The print buffer is a byte array. You should always blank a print buffer before printing strings to it.		
<i>P2</i> (l/C)	The size of the print buffer. The unit is byte (one-byte character). For example, if the size of a print buffer is 40, it has 20 words and can contain up to 40 one-byte characters.		
Example 1	BLANK(\$U100, 80) /* Blank the print buffer starting at \$U100 with a length of 40 words. */		

P2B

Format	<i>P1</i> = P2B (<i>P2</i> , <i>P3</i>)	Data Type	U
Function	Prints the null-terminated string <i>P1</i> to the print buffer <i>P2</i> at the specified byte position <i>P3</i> .		
<i>P1</i> (l)	The byte array that holds the string to be printed.		
<i>P2</i> (l)	The byte array that is used as a print buffer to accept the string <i>P1</i> .		
<i>P3</i> (l/C)	The byte position in the print buffer to put the string. The byte position counts from 0. For example, to print a string at the beginning of the print buffer, set <i>P3</i> to 0.		
Example 1	BLANK(\$U100, 20) /* Blank the print buffer. */ \$U10 = "Weight:" P2B(\$U100, \$U10, 0) /* Print the string "Weight:" at the position of byte 0 of the print buffer. */ \$U10 = I2A(1234, 2) /* The byte array \$U10 will hold the string "12.34" after this command is executed. */ P2B(\$U100, \$U10, 8) /* Print the string "12.34" at the position of byte 8 of the print buffer. */ \$U10 = "kg" P2B(\$U100, \$U10, 14) /* Print the string "kg" at the position of byte 14 of the print buffer. */ PRINT(\$U100, 20) /* Print string "Weight: 12.34 kg" in the print buffer to the real printer. */		

P2B_R

Format	<i>P1</i> = P2B_R (<i>P2</i> , <i>P3</i>)	Data Type	U
Function	Prints the null-terminated string <i>P1</i> to the print buffer <i>P2</i> . The string is right aligned with the byte position <i>P3</i> .		
<i>P1</i> (l)	The byte array that holds the string to be printed.		
<i>P2</i> (l)	The byte array that is used as a print buffer to accept the string <i>P1</i> .		
<i>P3</i> (l/C)	The byte position in the print buffer that the last characters of the string is placed. The byte position counts from 0. For example, to print a string with 6 characters at the beginning of the print buffer, set <i>P3</i> to 5 as the last character of the string should be placed at the position of byte 5.		
Example 1	BLANK(\$U100, 20) /* Blank the print buffer. */ \$U10 = "Weight:" P2B_R(\$U100, \$U10, 6) /* Print the string "Weight:" to the print buffer and align the string right with the position of byte 6. */ \$U10 = I2A(1234, 2) /* The byte array \$U10 will hold the string "12.34" after this command is executed. */ P2B_R(\$U100, \$U10, 12) /* Print the string "12.34" to the print buffer and align the string right with the position of byte 12. */ \$U10 = "kg" P2B_R(\$U100, \$U10, 15) /* Print the string "kg" to the print buffer and align the string right with the position of byte 15. */ PRINT(\$U100, 20) /* Print string "Weight: 12.34 kg" in the print buffer to the real printer. */		

14.4.20. Sound Operation

SOUND

Format	SOUND (<i>P1,P2,P3</i>)	Data Type	U
Function	Plays the sound <i>P1</i> .		
<i>P1</i> (I/C)	The identifier of the sound to be played. Note: The sounds and their identifiers are defined in the sound table of the panel application.		
<i>P2</i> (I/C)	The number of times you want the sound to be played. If you want the specified sound to be played just once, set <i>P2</i> to 1.		
<i>P3</i> (I/C)	The break time between two consecutive plays. The time unit is 100 ms (0.1 second). If you do not want any break between two plays, set <i>P3</i> to 0.		
Example 1	SOUND(10, 5, 3) /* Play the sound #10 5 times with a break of 0.3 second between two consecutive plays. */		

STOP_SOUND

Format	STOP_SOUND
Function	Stops playing the current sound.
Example 1	STOP_SOUND /* Stop playing the current sound.*/

CHAPTER 15

SCHEDULE

15.1. Using Schedule.....	1
15.2. Setting up the Schedule	2
15.2.1. General Settings.....	3
15.2.2. Schedule Details Dialog Box.....	6
15.2.3. Time Setting Block	8
15.3. Setting up Schedule Setting Table	11
15.3.1. Basic Operations.....	11
15.3.2. Operation Options.....	12
15.3.3. Settings	12
15.3.4. General Settings.....	12

15.1. Using Schedule

The schedule function allows the HMI to perform a specified operation at the designated time. For example, the HMI can turn on a motor at the designated start time and turn off that motor at the designated end time. Another example is that the HMI can set the running mode temperature at the designated start time of a process and reset the temperature to the standby temperature at the designated end time of that process.

Up to 48 schedules (Number 1 to Number 48) can be registered in a panel application. Each schedule can be programmed to either change the value of a specified PLC location or execute a specified macro at the designated time.

To use schedule in your application, please do the following:

- 1. Setting up Schedule
Described in [Section 15.2](#)
- 2. Creating and configuring Schedule Setting Table screen object
Described in [Section 15.3](#)

Notes:

- 1. The time schedule features are one time actions. When the Start Time is reached, the designated device address is written to just once. The write action is not repeated.

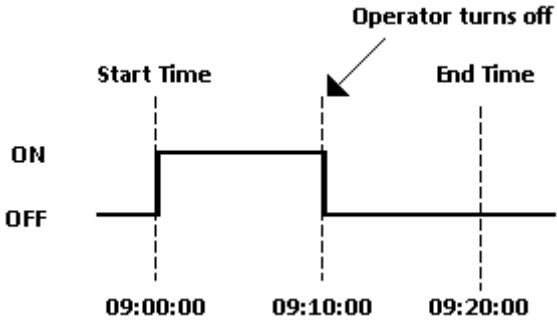

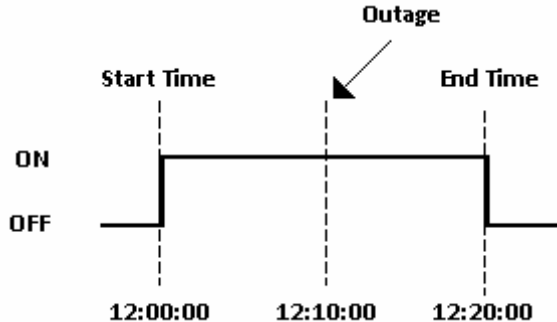

- 2. The Start Value and the Prohibit Action Bit are read only once at the beginning of the time range. Since regular readout is not possible, there may be a slight data communication delay that causes a slight delay in the Start Time. Due to the same reason, the delay may occur in the End Time.
- 3. When the time range of a schedule is changed by whatever method and the current time is inside the time range, the start action is performed.
- 4. When the same Start Times and End Times appear in multiple schedules, they are handled in order, starting from the smallest schedule number.
- 5. If the Start Action is completed and then a power outage occurs, the End Action will be performed at the End Time after the power is resumed.



15.2. Setting up the Schedule

You can set up the schedule with the Schedule dialog box. To open the Schedule dialog box of a panel application, use one of the following methods:

- 1) In the Project Manager window, double-click the Schedule node () under Setup node of the concerned panel application
- 2) In the Project Manager window, right-click the Schedule node () under Setup node of the concerned panel application to bring out the pop-up menu and select Properties.
- 3) In the menu bar, click Panel ->Schedule. Note that the concerned panel application must be the current panel application or you will be working on the current panel application instead of the concerned panel application.

The Schedule dialog box contains the following pages. Some of the pages appear only when they are needed.

- **General**

Described in [Section 15.2.1](#).

- **Start Macro / End Macro**

Described in [Section 14.2.6](#).

15.2.1. General Settings

This section describes how to define the general settings for schedule. The following is an example of the General page of the Schedule dialog box.

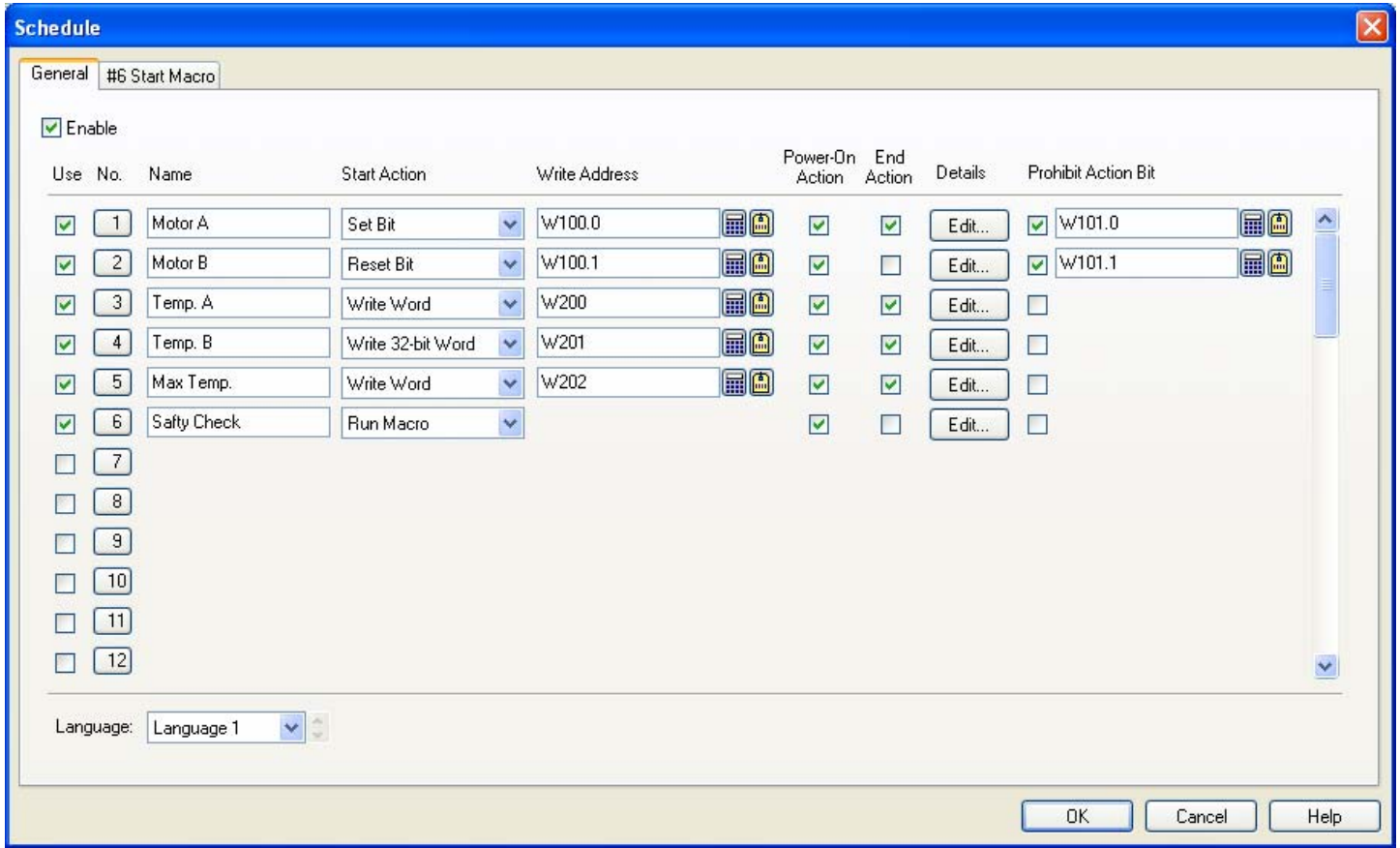

To enable the schedule function for the application, check the Enable box in the dialog box.

The following describes how to set up a time schedule.

Item	Description
Use	To register the schedule, check the Use box of the schedule first. During project development, you can un-register the schedule temporarily by un-checking the Use box. The entered settings will not be lost after un-checking.
ID	The pre-assigned identifier of the schedule.
Name	Specify the schedule name for each language. The schedule name will be shown on the Schedule Setting Table screen object. The maximum length of a schedule name is 24 characters. To select the language you are working on, use the Language combo box on the bottom of the dialog box.

Continued

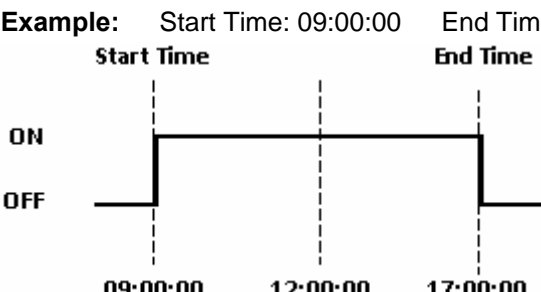
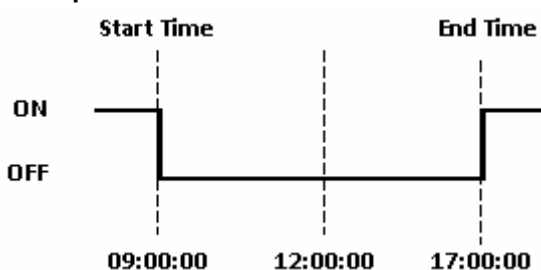
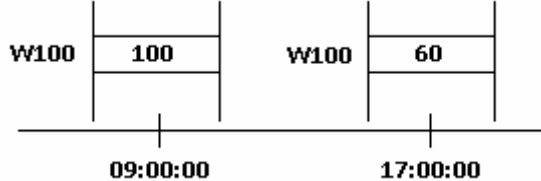
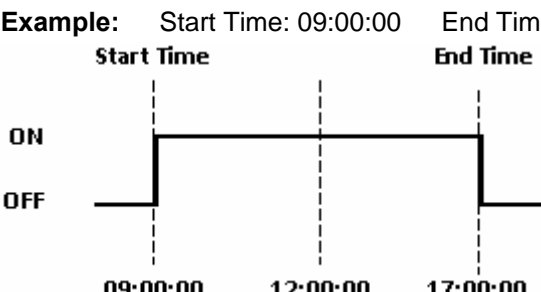
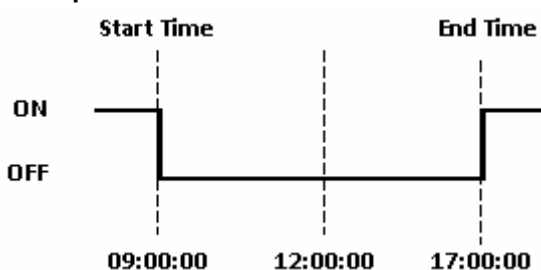
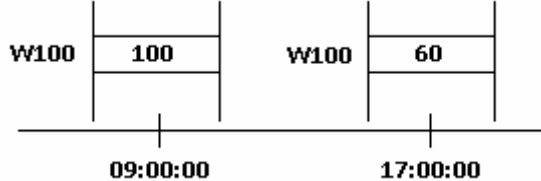
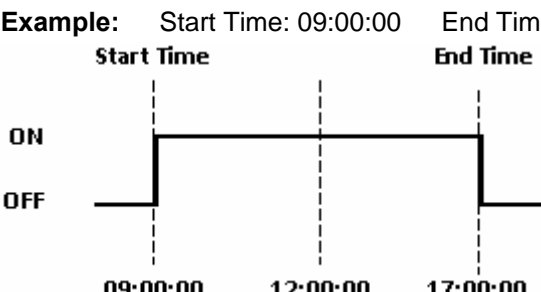
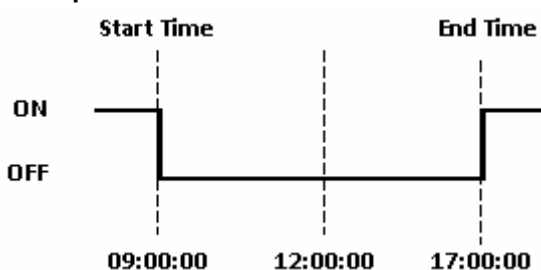
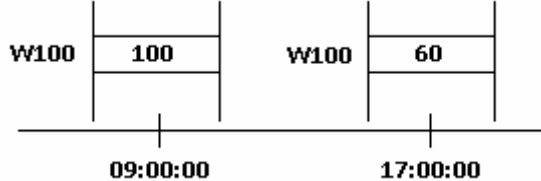
Item	Description												
Start Action	<p>Specify the action you want the HMI to perform at the Start time and the End time. The following table describes the five options.</p> <table border="1" data-bbox="316 302 1484 1971"> <thead> <tr> <th data-bbox="316 302 587 342">Action</th> <th data-bbox="587 302 1484 342">Description</th> </tr> </thead> <tbody> <tr> <td data-bbox="316 342 587 757">Set Bit</td> <td data-bbox="587 342 1484 757"> <p>Sets the specified bit to On at the Start Time. If the End Action is selected, it resets the specified bit to Off at the End Time.</p> <p>Example: Start Time: 09:00:00 End Time: 17:00:00</p>  </td> </tr> <tr> <td data-bbox="316 757 587 1171">Reset Bit</td> <td data-bbox="587 757 1484 1171"> <p>Resets the specified bit to Off at the Start Time. If the End Action is selected, it sets the specified bit to On at the End Time.</p> <p>Example: Start Time: 09:00:00 End Time: 17:00:00</p>  </td> </tr> <tr> <td data-bbox="316 1171 587 1641">Write Word</td> <td data-bbox="587 1171 1484 1641"> <p>Writes the Start Value to the specified word at the Start Time. If the End Action is selected, it writes the End Value to the specified word at the End Time.</p> <p>Example: Start Time: 09:00:00 End Time: 17:00:00 Start Value: 100 End Value: 60 Write Address: W100</p>  </td> </tr> <tr> <td data-bbox="316 1641 587 1742">Write 32-bit Word</td> <td data-bbox="587 1641 1484 1742"> <p>Writes the Start Value to the specified double-word at the Start Time. If the End Action is selected, it writes the End Value to the specified double-word at the End Time.</p> </td> </tr> <tr> <td data-bbox="316 1742 587 1971">Run Macro</td> <td data-bbox="587 1742 1484 1971"> <p>Runs the specified Start Macro at the Start Time. If the End Action is selected, it runs the specified End Macro at the End Time.</p> <p>The corresponding Start Macro tab is added to the dialog box when the Run Macro action is selected. You can edit the Start Macro in the Start Macro tab. When the End Action is selected, the corresponding End Macro tab is added to the dialog box when the End Action is selected. You can edit the End Macro in the End Macro tab.</p> </td> </tr> </tbody> </table> <p>Note: The Start Time, End Time, Start Value, and End Value mentioned in the above table are specified in the Schedule Settings dialog box.</p>	Action	Description	Set Bit	<p>Sets the specified bit to On at the Start Time. If the End Action is selected, it resets the specified bit to Off at the End Time.</p> <p>Example: Start Time: 09:00:00 End Time: 17:00:00</p> 	Reset Bit	<p>Resets the specified bit to Off at the Start Time. If the End Action is selected, it sets the specified bit to On at the End Time.</p> <p>Example: Start Time: 09:00:00 End Time: 17:00:00</p> 	Write Word	<p>Writes the Start Value to the specified word at the Start Time. If the End Action is selected, it writes the End Value to the specified word at the End Time.</p> <p>Example: Start Time: 09:00:00 End Time: 17:00:00 Start Value: 100 End Value: 60 Write Address: W100</p> 	Write 32-bit Word	<p>Writes the Start Value to the specified double-word at the Start Time. If the End Action is selected, it writes the End Value to the specified double-word at the End Time.</p>	Run Macro	<p>Runs the specified Start Macro at the Start Time. If the End Action is selected, it runs the specified End Macro at the End Time.</p> <p>The corresponding Start Macro tab is added to the dialog box when the Run Macro action is selected. You can edit the Start Macro in the Start Macro tab. When the End Action is selected, the corresponding End Macro tab is added to the dialog box when the End Action is selected. You can edit the End Macro in the End Macro tab.</p>
Action	Description												
Set Bit	<p>Sets the specified bit to On at the Start Time. If the End Action is selected, it resets the specified bit to Off at the End Time.</p> <p>Example: Start Time: 09:00:00 End Time: 17:00:00</p> 												
Reset Bit	<p>Resets the specified bit to Off at the Start Time. If the End Action is selected, it sets the specified bit to On at the End Time.</p> <p>Example: Start Time: 09:00:00 End Time: 17:00:00</p> 												
Write Word	<p>Writes the Start Value to the specified word at the Start Time. If the End Action is selected, it writes the End Value to the specified word at the End Time.</p> <p>Example: Start Time: 09:00:00 End Time: 17:00:00 Start Value: 100 End Value: 60 Write Address: W100</p> 												
Write 32-bit Word	<p>Writes the Start Value to the specified double-word at the Start Time. If the End Action is selected, it writes the End Value to the specified double-word at the End Time.</p>												
Run Macro	<p>Runs the specified Start Macro at the Start Time. If the End Action is selected, it runs the specified End Macro at the End Time.</p> <p>The corresponding Start Macro tab is added to the dialog box when the Run Macro action is selected. You can edit the Start Macro in the Start Macro tab. When the End Action is selected, the corresponding End Macro tab is added to the dialog box when the End Action is selected. You can edit the End Macro in the End Macro tab.</p>												

Continued

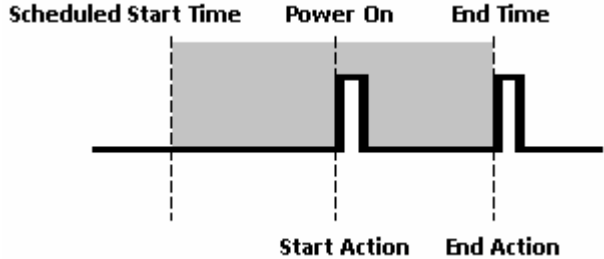
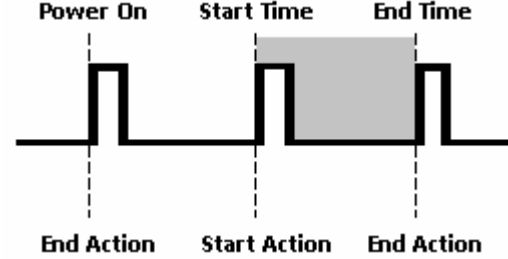
Item	Description												
Write Address	Specify the target address for the desired action.												
	<table border="1"> <thead> <tr> <th data-bbox="300 280 587 324">For Action</th> <th data-bbox="587 280 1511 324">Address Type</th> </tr> </thead> <tbody> <tr> <td data-bbox="300 324 587 369">Set Bit</td> <td data-bbox="587 324 1511 369">Bit address</td> </tr> <tr> <td data-bbox="300 369 587 414">Reset Bit</td> <td data-bbox="587 369 1511 414">Bit address</td> </tr> <tr> <td data-bbox="300 414 587 459">Write Word</td> <td data-bbox="587 414 1511 459">An address that can refer to a 16-bit datum</td> </tr> <tr> <td data-bbox="300 459 587 504">Write 32-bit Word</td> <td data-bbox="587 459 1511 504">An address that can refer to a 32-bit datum</td> </tr> </tbody> </table>	For Action	Address Type	Set Bit	Bit address	Reset Bit	Bit address	Write Word	An address that can refer to a 16-bit datum	Write 32-bit Word	An address that can refer to a 32-bit datum		
	For Action	Address Type											
	Set Bit	Bit address											
	Reset Bit	Bit address											
Write Word	An address that can refer to a 16-bit datum												
Write 32-bit Word	An address that can refer to a 32-bit datum												
Power-On Action	Select the action to perform when the power is turned on.												
	<p>Power-On Action is Enabled (Checked)</p>												
	<p>If the HMI is turned on inside of the scheduled range, the Start Action is performed.</p> 												
	<p>If the HMI is turned on outside of the scheduled range and the End Action is enabled, the End Action is performed.</p> 												
End Action	Check the item to enable the End Action. If the End Action is enabled, the HMI will do one of the following operations at the designated End Time according to the selected Start Action.												
	<table border="1"> <thead> <tr> <th data-bbox="300 1556 566 1601">Start Action</th> <th data-bbox="566 1556 1511 1601">End Action</th> </tr> </thead> <tbody> <tr> <td data-bbox="300 1601 566 1646">Set Bit</td> <td data-bbox="566 1601 1511 1646">Resets the specified bit to Off at the End Time.</td> </tr> <tr> <td data-bbox="300 1646 566 1691">Reset Bit</td> <td data-bbox="566 1646 1511 1691">Sets the specified bit to On at the End Time.</td> </tr> <tr> <td data-bbox="300 1691 566 1736">Write Word</td> <td data-bbox="566 1691 1511 1736">Writes the End Value to the specified word at the End Time.</td> </tr> <tr> <td data-bbox="300 1736 566 1780">Write 32-bit Word</td> <td data-bbox="566 1736 1511 1780">Writes the End Value to the specified double-word at the End Time.</td> </tr> <tr> <td data-bbox="300 1780 566 1825">Run Macro</td> <td data-bbox="566 1780 1511 1825">Runs the specified End Macro.</td> </tr> </tbody> </table>	Start Action	End Action	Set Bit	Resets the specified bit to Off at the End Time.	Reset Bit	Sets the specified bit to On at the End Time.	Write Word	Writes the End Value to the specified word at the End Time.	Write 32-bit Word	Writes the End Value to the specified double-word at the End Time.	Run Macro	Runs the specified End Macro.
	Start Action	End Action											
	Set Bit	Resets the specified bit to Off at the End Time.											
	Reset Bit	Sets the specified bit to On at the End Time.											
	Write Word	Writes the End Value to the specified word at the End Time.											
Write 32-bit Word	Writes the End Value to the specified double-word at the End Time.												
Run Macro	Runs the specified End Macro.												
Details	Click the Edit button to open the Schedule Details dialog box. You can specify the Start Time, End Time, Start Value, and End Value of the schedule in the Schedule Details dialog box. See Section 15.2.2 for details.												
Prohibit Action Bit	Select to prohibit the schedule function by using the specified Prohibit Action Bit. At the Start Time, the value of the Prohibit Action Bit is read before the start action is performed. If the value is on, the schedule action is not performed for the current cycle.												

15.2.2. Schedule Details Dialog Box

In the Schedule Details dialog box, you can specify the Start Time/Date, End Time/Date, Start Value, and End Value of a schedule. To open the Schedule Details dialog box of a schedule, click the Edit button of the schedule in the Schedule dialog box.

Example 1

- 1) The time range starts at 09:00:00 on Monday and ends at 18:00:00 on Thursday.
- 2) The operators are allowed to modify the time range by using the Schedule Setting Table at runtime.
- 3) The Start Value and End Value are floating point numbers. When the schedule starts, the HMI outputs the Start Value read from the internal words \$U120 and \$U121 to the specified Write Address. When the schedule ends, the HMI outputs the End Value read from the internal words \$U122 and \$U123 to the specified Write Address.

The screenshot shows the 'Schedule Details' dialog box. The 'Schedule No.' is 4. The 'Special Day' checkbox is unchecked. Under 'Time Range', the 'Constant' radio button is selected, and the 'Changeable with Schedule Setting Table' checkbox is checked. The 'Individual start and end days' checkbox is also checked. The 'Start Time' is 09:00:00 and the 'Start Day' is MON. The 'End Time' is 18:00:00 and the 'End Day' is THU. In the 'Output Value' section, the 'Variable' radio button is selected, the 'Data Type' is '32-Bit Floating Point', the 'Start Value' is \$U120, and the 'End Value' is \$U122. There are 'OK' and 'Cancel' buttons at the top right.

Example 2

- 1) The time range can be set by a device/PLC. The memory block starts at W100 of the PLC will be used for setting the time range.
- 2) Before a valid time range is set at runtime, the default time range specified in the dialog box will be used. The default time range starts at 09:00:00 and ends at on every weekday.
- 3) The operators are allowed to modify the time range by using the Schedule Setting Table at runtime.
- 4) The Start Value and End Value are 16-bit unsigned integers. When the schedule starts, the HMI outputs the Start Value read from the PLC word location W30 to the specified Write Address. When the schedule ends, the HMI outputs the End Value read from the PLC word location W31 to the specified Write Address.

The screenshot shows the 'Schedule Details' dialog box. The 'Schedule No.' is 8. The 'Special Day' checkbox is unchecked. Under 'Time Range', the 'Variable' radio button is selected, and the 'Changeable with Schedule Setting Table' checkbox is checked. The 'Time Setting Address' is W100. The 'Default Time' checkbox is checked. The 'Individual start and end days' checkbox is unchecked. The 'Start Time' is 09:00:00 and the 'End Time' is 17:00:00. The 'Applied Days' section has checkboxes for SUN, MON, TUE, WED, THU, FRI, and SAT, with MON, TUE, WED, THU, and FRI checked. In the 'Output Value' section, the 'Variable' radio button is selected, the 'Data Type' is '16-Bit Unsigned Integer', the 'Start Value' is W30, and the 'End Value' is W31. There are 'OK' and 'Cancel' buttons at the top right.

Example 3

- 1) The time range starts at 07:30:00 and ends at 20:30:00 on April 10.
- 2) It is not allowed to modify the time range in the Schedule Setting Table at runtime.
- 3) The Start Value and End Value are 16-bit unsigned integers. When the schedule starts, the HMI writes 100 to the specified Write Address. When the schedule ends, the HMI writes 60 to the specified Write Address.

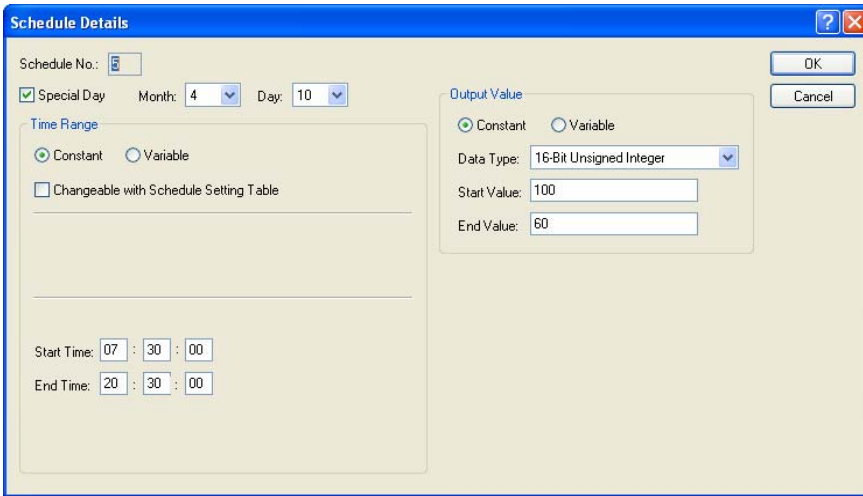

The following describes the items in the Schedule Details dialog box.

Item		Description
Schedule No.		The number of the concerned schedule. The field is read only.
Special Day		Select to make the schedule valid only for the specified day.
Month		The month of the Special Day.
Day		The day of the Special Day.
Time Range	Constant	Select to make the time range non-settable by a device/PLC.
	Variable	Select to make the time range settable by a device/PLC.
Changeable with Schedule Setting Table		Select to allow the operators to change the time range by using the Schedule Setting Table at runtime.
Time Setting Address		Specify the starting address of the Time Setting Block that the device/PLC will use to set the time range of the schedule. See section 15.2.3 for the details of the Time Setting Block.
Default Time		Select to allow the schedule to have a default time range. This item is visible only when the Variable is selected for the Time Range. The HMI will use the default time range for the schedule if there is no valid time range set by the PLC or by the operator yet.
Individual start and end days		Select to indicate that the start day and end day of the schedule are different.
Start Time		The start time of the schedule.
Start Day		The start day of the schedule. The item is visible when the “Individual start and end days” is selected.
End Time		The end time of the schedule.
End Day		The end day of the schedule. The item is visible when the “Individual start and end days” is selected.
Applied Days		Select the day or days in a week that the schedule will apply.
Output Value	Constant	Select this item to indicate that the start value and the end value are constants.
	Variable	Select this item to indicate that the start value and the end value are to be read from the specified addresses.
Data Type		Specify the data type of the start and end values.
Start Value		Specify the start value or the address to get the start value.
End Value		Specify the end value or the address to get the end value.

15.2.3. Time Setting Block

The following table shows the word arrangement of the Time Setting Block.

Word No.	Usage	Description
0	Time Setting Control Word	See section 15.2.3.1 for the details
1	Time Setting Status Word	See section 15.2.3.2 for the details
2	Action Mode	See section 15.2.3.3 for the details
3	Start Day or the month of the Special Day	See section 15.2.3.4 for the details
4	Start Time (Hour)	Hour: 0-23
5	Start Time (Min.)	Minute: 0-59
6	Start Time (Sec.)	Second: 0-59
7	End Day or the day of the Special Day	See section 15.2.3.4 for the details
8	End Time (Hour)	Hour: 0-23
9	End Time (Min.)	Minute: 0-59
10	End Time (Sec.)	Second: 0-59

15.2.3.1. Time Setting Control Word (Word 0 of Time Setting Block)

Bit	15		1	0
	Reserved (Must be 0)			0

Bit 0: Time Acquisition Request Bit

When the HMI detects that the Time Acquisition Request Bit turns on (from 0 to 1), it reads out from word 2 to word 10 of the Time Setting Block to get the Action Mode, the Start Time, and the End Time for the schedule.

15.2.3.2. Time Setting Status Word (Word 1 of Time Setting Block)

Bit	15	2	1	0	
	Reserved (Must be 0)			0	0

Bit 0: Time Acquisition Completion Bit

- 0: Either Time Acquisition is being performed or have not been performed
- 1: Time Acquisition completed

Bit 1: Error Notification Bit

- 0: Time data is being replaced with correct data
- 1: Time data contains an error

Note:

- 1) The device/PLC must turn the Time Acquisition Request Bit off (1 to 0) when recognizes that the Time Acquisition Completion Bit turns on (0 to 1)
- 2) When the HMI detects that the Time Acquisition Request Bit is turned off (1 to 0), it turns off the Time Acquisition Completion Bit and Error Notification Bit immediately.

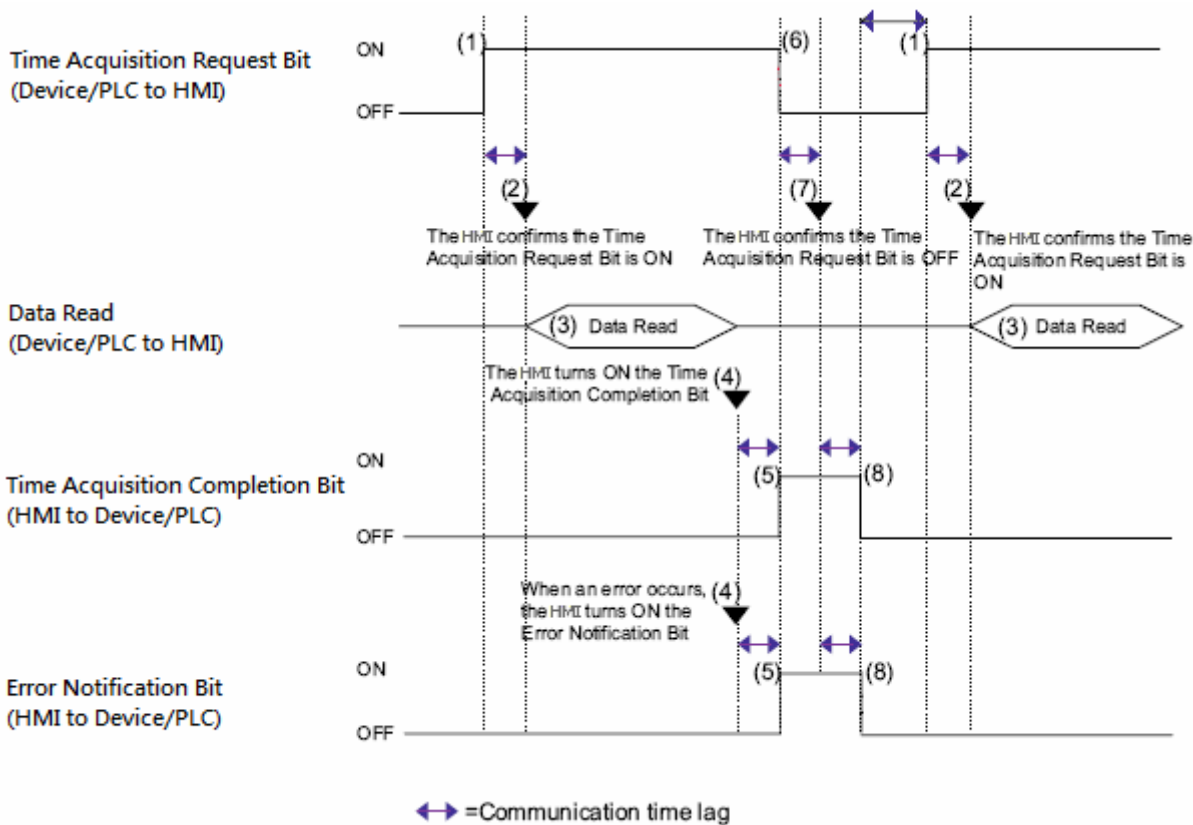

15.2.3.3. Action Mode (Word 2 of Time Setting Block)

Bit	15		2	1	0
	Reserved (Must be 0)			0	0

Bit 0: End Action Bit

- 0: Disable the End Action of the schedule
- 1: Enable the End Action of the schedule

Bit 1: Individual Day Specification Bit

- 0: The Start Day and End Day of the schedule are the same.
- 1: The Start Day and End Day of the schedule are different.

Note:

If Individual Day Specification Bit is 1 and two or more of the Start/End Day bits turn on simultaneously, an error occurs.

15.2.3.4. Start Day (Word 3 of Time Setting Block), End Day (Word 7 of Time Setting Block)

Designate the day used as a trigger for the Start/End Action.

Bit	15		07	06	05	04	03	02	01	00
	Reserved (Must be 0)			Sat.	Fri.	Thu.	Wed.	Tue.	Mon.	Sun.

Bit 00: Sunday (0: None, 1: Designate)

Bit 01: Monday (0: None, 1: Designate)

Bit 02: Tuesday (0: None, 1: Designate)

Bit 03: Wednesday (0: None, 1: Designate)

Bit 04: Thursday (0: None, 1: Designate)

Bit 05: Friday (0: None, 1: Designate)

Bit 06: Saturday (0: None, 1: Designate)

If the schedule is configured for the Special Day, the high byte of word 3 (Start Day) should contain the month (1-12) of the Special Day and the low byte of word 3 should contain the day (1-31) of the Special Day. The content of word 7 (End Day) should be 0.

	High byte (Bit 15-8)	Low byte (Bit 7-0)
Start Day	Month of the Special Day (1-12)	Day of the Special Day (1-31)
End Day:	0	

15.3. Setting up Schedule Setting Table

15.3.1. Basic Operations

You can display a list of schedules by using the schedule setting table. And the operators are allowed to change the time range of a schedule with the Schedule Setting Table at runtime.

ID	Name	Status	Set	Start Time	End Time	Applied Days
1	Motor A	■		00:00:00	23:00:00	MON
2	Motor B	<input type="checkbox"/>		MON 05:00:00	FRI 20:00:00	
3	Temp. A	■	<input type="checkbox"/>	09:00:00	17:00:00	MON/TUE/WED/THU/FRI
4	Temp. B	■	<input type="checkbox"/>	MON 09:00:00	THU 18:00:00	
5	Max Temp.	■		07:30:00	20:30:00	04/10
6	Safety Check	■		08:00:00	23:00:00	01/01

The above is an example of the schedule setting table. The first row is the title row. It displays the title of each column. The other rows display one schedule per row. You can create scroll button groups or scroll bars to scroll the contents. A schedule setting table can have seven columns. The following table describes the content of each column for a schedule setting table.

Column	Description
Schedule No.	The number of the associated schedule. This column is optional.
Schedule Name	The name of the associated schedule.
Status	The current status of the associated schedule. The status includes: Active, Inactive, Prohibited, Error.
Set	<p>If the associated schedule is changeable, there is a button shown in the column. Click the button, you will see the following sample Set Schedule dialog that allows the operator to change the time range of the associated schedule.</p> <div style="display: flex; justify-content: space-around;"> <div style="border: 1px solid gray; padding: 5px; width: 45%;"> <p>Set Schedule</p> <p>Schedule ID: 3</p> <p><input type="checkbox"/> Individual Start Day and End Day</p> <p>Start Time: <input type="text" value="09"/> : <input type="text" value="00"/> : <input type="text" value="00"/></p> <p>End Time: <input type="text" value="17"/> : <input type="text" value="00"/> : <input type="text" value="00"/></p> <p>Applied Days:</p> <p><input type="checkbox"/> Sun. <input checked="" type="checkbox"/> Mon. <input checked="" type="checkbox"/> Tue. <input checked="" type="checkbox"/> Wed. <input checked="" type="checkbox"/> Thu. <input checked="" type="checkbox"/> Fri. <input type="checkbox"/> Sat.</p> <p style="text-align: right;"><input type="button" value="OK"/> <input type="button" value="Cancel"/></p> </div> <div style="border: 1px solid gray; padding: 5px; width: 45%;"> <p>Set Schedule</p> <p>Schedule ID: 4</p> <p><input checked="" type="checkbox"/> Individual Start Day and End Day</p> <p>Start Time: <input type="text" value="09"/> : <input type="text" value="00"/> : <input type="text" value="00"/> Start Day: <input type="text" value="Mon"/> <input checked="" type="checkbox"/></p> <p>End Time: <input type="text" value="18"/> : <input type="text" value="00"/> : <input type="text" value="00"/> End Day: <input type="text" value="Thu."/> <input checked="" type="checkbox"/></p> <p style="text-align: right;"><input type="button" value="OK"/> <input type="button" value="Cancel"/></p> </div> </div> <p>To set the dialog, please see Section 15.2.2 for details.</p>
Start Time	The start time of the schedule.
End Time	The end time of the schedule.
Applied Days	The day or days in a week that the schedule will apply.

The text color and font of a row are determined by the settings in the General Page.

15.3.2. Operation Options

The following operation option can be added to a schedule setting table. Select and set the option in the Schedule Setting Table dialog box.

Options	Description
Visibility Control	You can show and hide a schedule setting table with a specified bit or the current user level. Select and set this option in the Visibility page.

15.3.3. Settings

You can complete all the settings of a schedule setting table in the Schedule Setting Table dialog box. This dialog box contains the following three pages.

- **General**

Described in [Section 15.3.4](#).

- **Advanced**

Described in [Section 4.4.5](#).

- **Visibility**

Described in [Section 4.4.6](#).

15.3.4. General Settings

This section describes how to define the general settings for a schedule setting table. The following is an example of the General page of the Schedule Setting Table dialog box.

Schedule Setting Table

General | Advanced | Visibility

ID: SST0000 Note:

Shape...
 Border Color: █
 BG Color: █

GF_0031

Title
 Language: English
 Font: Arial_9_Bold
 Color: █ BG Color: █
 Show Schedule ID
 Schedule No.: ID
 Schedule Name: Name
 Status: Status
 Set: Set
 Start Time: Start Time
 End Time: End Time
 Applied Days: Applied Days

Text
 Language: English
 Font: Arial_9_Regular
 Color: █
 Date Format: MM/DD
 Abbreviation
 Sunday: SUN
 Monday: MON
 Tuesday: TUE
 Wednesday: WED
 Thursday: THU
 Friday: FRI
 Saturday: SAT

Status Color
 Active: █
 Inactive: █
 Prohibited: █
 Error: █

Grid
 Horizontal
 Vertical
 Color: █

Line Spacing: 2
 Item Spacing: 2

Show Schedule
 1 2 3 4 5
 6

Select All Clear All

OK Cancel Help

The following table describes each property in the General page.

Property		Description
ID		The object's identifier. It is generated when the object is created. The identifier is unique within the screen where the object is located and is unchangeable. The format of the IDs for the schedule setting table is SSTnnnn.
Note		You can type a note for the object.
Shape settings		For details about the following properties, see Section 4.3.4 Setting up the Shape of an Object.  , Border Color, BG Color
Title	Language	Select a language so you can view and edit the language dependent settings in the Title group for that language. The language dependent properties in the Title group include Font and Title Name.
	Font	Select a font for the title text.
	Color	Select a color for the text.
	BG Color	Select a color for the title row.
	Show Schedule ID	Check this option if you want the schedule setting table to have the ID column.
	Schedule No.	Specifies the title for the Schedule No. column. This field is available when Show Schedule ID is selected
	Schedule Name/ Status/Set/ Start Time/ End Time/ Applied Days	Specifies the title for the Schedule Name/ Status/Set/ Start Time/ End Time/ Applied Days column.
Text	Language	Select a language so you can view and edit the language dependent settings in the Text group for that language. The language dependent properties in the Text group include Font and Abbreviation.
	Font	Select a font for the text.
	Color	Select a color for the text.
	Data Format	Select a format for displaying the date.
	Abbreviation	Specifies the abbreviation text for the Sunday/ Monday/Tuesday/ Wednesday/ Thursday/ Friday/Saturday.
Status Color	Active	Select a color that will be shown in Status column when the schedule starts.
	Inactive	Select a color that will be shown in Status column when the schedule ends.
	Prohibited	Select a color that will be shown in Status column when the schedule is prohibited.
	Error	Select a color that will be shown in Status column when the schedule has an error.
Grid	Horizontal	Select this option if you want the schedule setting table to have horizontal grids.
	Vertical	Select this option if you want the schedule setting table to have vertical grids.
	Color	Select a color for the grids.
Line Spacing		Specifies the extra space in pixels for two adjacent rows of the schedule setting table.
Item Spacing		Specifies the extra space for every column of the schedule setting table.
Show Schedule	<Check Box>	All the schedules will be listed. Check the schedule No. if you want the schedule setting table to show the associated schedule.
	Select All	Click the button to select all schedules.
	Clear All	Click the button to clear all the selections.

CHAPTER 16



INCREASE EFFICIENCY

16.1. Finding and Replacing	1
16.1.1. Finding/Replacing Texts or Addresses	1
16.1.2. Find Result Window	2
16.1.3. Quick Find and Replace in Macro Editor Window	3
16.2. Screen Overview	4
16.3. Link Overview	7
16.4. Object Library	10
16.5. Object List.....	12
16.6. I/O List.....	13

16.1. Finding and Replacing

You can use the Find/Replace tool to find and replace texts or addresses used in the project.

16.1.1. Finding/Replacing Texts or Addresses

This section describes how to find or replace texts or addresses using the Find/Replace dockable window or the Find/Replace dialog box.

The following is an example of the Find/Replace dockable window for finding Text/Address.
To open the window, use the Find... command on the Edit > Find and Replace menu.

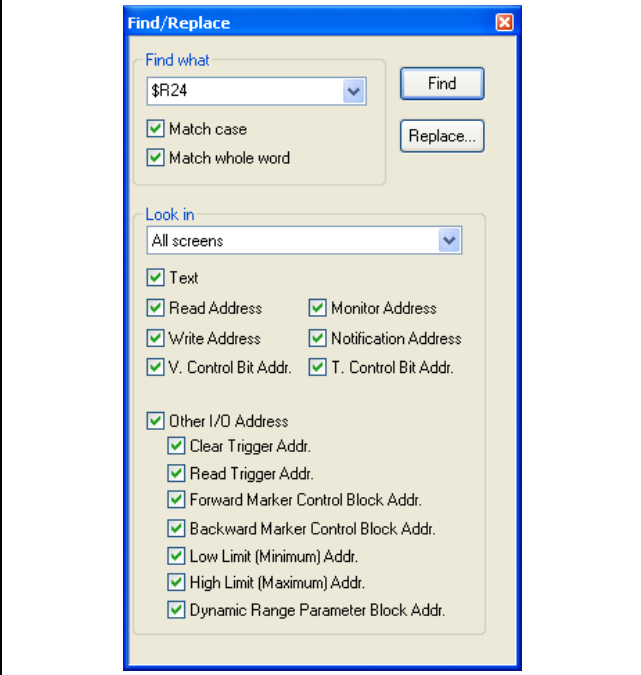

The following is an example of the Find/Replace dialog box for replacing Text/Address.
To open the dialog box, use Replace... command on the Edit > Find and Replace menu.

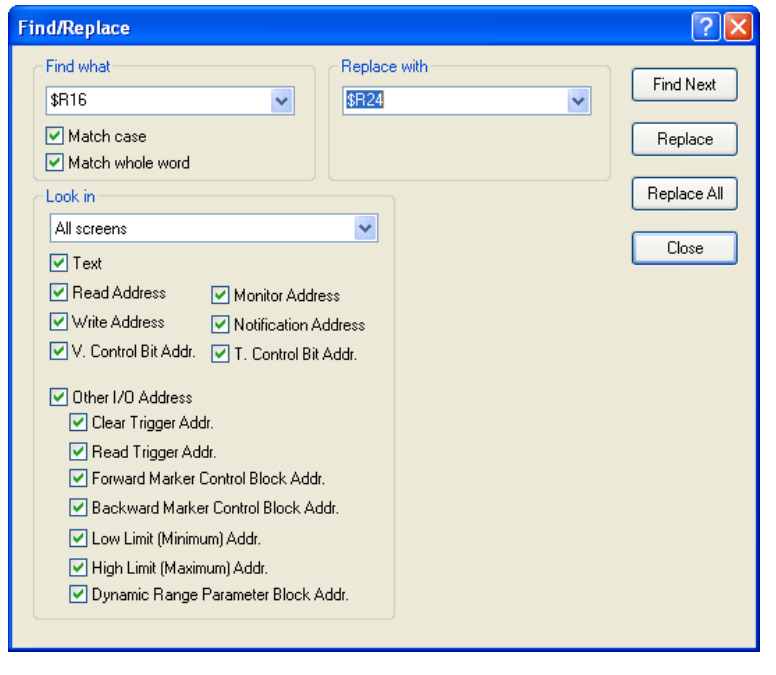

The following table describes each property in the Find/Replace dockable window/dialog box.

Property		Description
Find what	<Combo Box>	Type the text /address you want to search for, paste it from the clipboard or click a recent entry from the list.
	Match case	Check this option to search only for occurrences that match the combination of uppercase and lowercase characters you enter in the Find what box.
	Match whole word	Check this option to search only for whole words instead of matching the text entered in the Find what box as it occurs within words.
Look in	<Combo Box>	Select one of the following portions of the project you want to search in. Current screen, Current panel application's screens, All screens, Current Macro, Current panel application's macro, All macros, Current panel application's tags, Tags of all panel applications.
	Text/Address	Click any of the listed options to specify the type of text/address to search for.
In dockable window	Find	Click the button to find the specified text or address with selected options. The matches for the search appear in the Find Result window. Please see Section 16.1.2. for details about the Find Result window.
	Replace...	Click the button to bring up the Find/Replace dialog box to do the replacing operation.

Continued

Property		Description
In dialog box	Replace with	Type the text you want to replace the find text with, paste it from the clipboard or click a recent entry from the list.
	Find Next	Click the button to find the next occurrence of the text/address specified in the Find what box with selected options until there are no more occurrences. The matches for the search appear in the Find Result window. Please see Section 16.1.2. for details about the Find Result window.
	Replace	Click this button to search for text that matches the find text, then replace it with the text in the Replace with field. The replacement information appears in the Find Result window. Please see Section 16.1.2. for details about the Find Result window.
	Replace All	Replaces all occurrences of the find text with the text in the Replace with field. The replacement information appears in the Find Result window. Please see Section 16.1.2. for details about the Find Result window.
	Close	Click the button to close the dialog box.

16.1.2. Find Result Window

The Find Result window is a dockable window. It lists all the search matches and replacement information. The following is an example of the Find Result window. You can browse the search matches or replacements by double-clicking each entry in the Find Result Window.

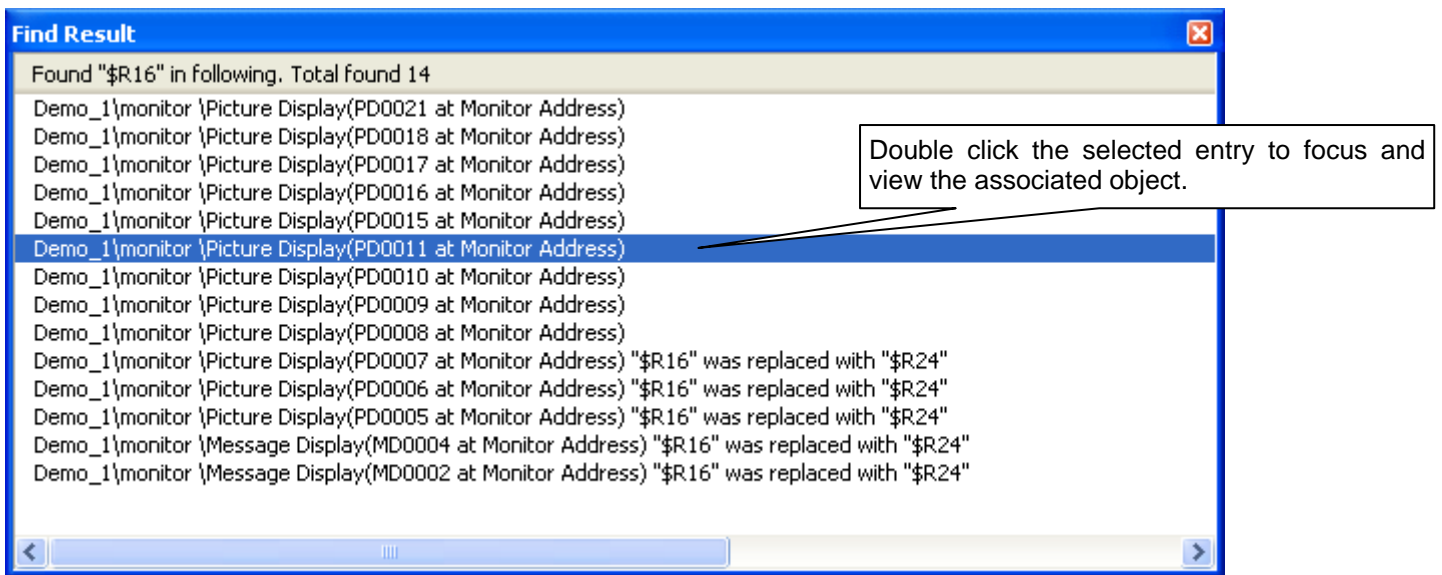

You can right-click the Find Result window to get the pop-up menu with the following menu items:

Menu Item	Description
Clear	Clears all the entries in the window.

16.1.3. Quick Find and Replace in Macro Editor Window

Quick find and replace allows you to search the text in a currently active macro editor window. The selection moves from match to match, allowing you to review each match within its context.

In the currently active macro editor window, quick find and replace can search or replace through a macro forward from the insertion point. The search or replace automatically continues past the end of the macro into the unsearched portion. A message appears when the entire macro has been searched or replaced.

Note: The matches found are not listed in the Find Results window

To display the Replace dialog box, use the Replace... command on the Edit > Find and Replace menu. The following is an example of the Replace dialog.

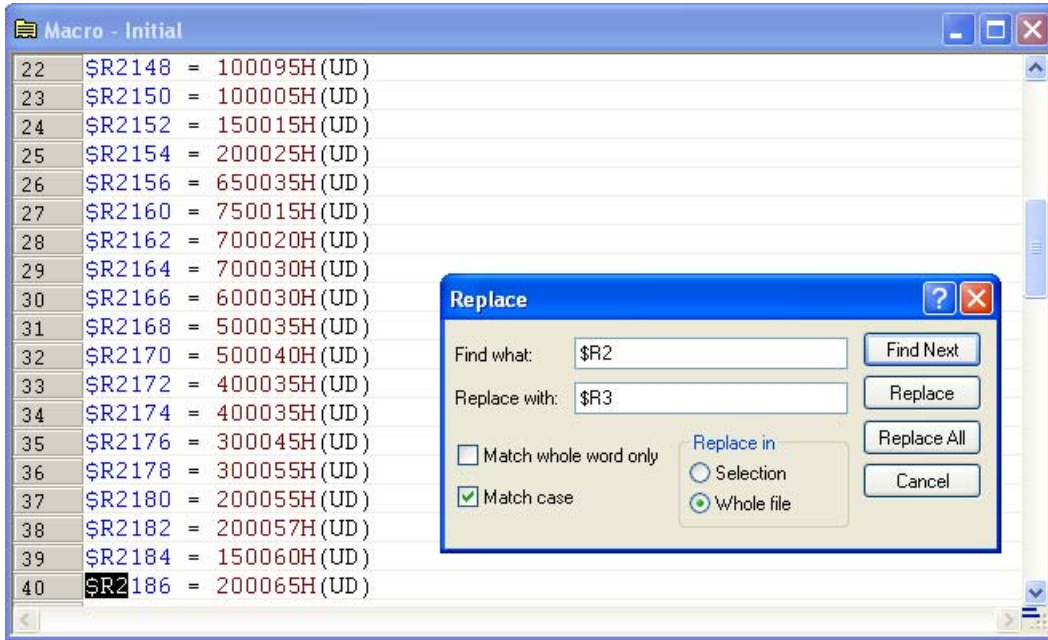

The following table describes each property in the Replace dialog box.

Property	Description						
Find what	Type the text you want to search for or paste it from the clipboard.						
Replace with	Type the text you want to replace the found text with or paste it from the clipboard.						
Match whole word only	Check this option to search only for whole words rather than matching the text you enter in the Find what box as it occurs within words.						
Match case	Check this option to search only for occurrences that match the combination of uppercase and lowercase characters you enter in the Find what box.						
Replace in	Select one of the following portions for the project you want to search in <table border="1" style="width: 100%; border-collapse: collapse;"> <thead> <tr> <th>Option</th> <th>Description</th> </tr> </thead> <tbody> <tr> <td>Selection</td> <td>Searches or replaces only the selected text in the currently active document.</td> </tr> <tr> <td>Whole file</td> <td>Searches or replaces all content displayed in this window for the Find what string.</td> </tr> </tbody> </table>	Option	Description	Selection	Searches or replaces only the selected text in the currently active document.	Whole file	Searches or replaces all content displayed in this window for the Find what string.
Option	Description						
Selection	Searches or replaces only the selected text in the currently active document.						
Whole file	Searches or replaces all content displayed in this window for the Find what string.						
Find Next	Click the button to find the next occurrence of the text specified in the Find what box with the selected options until there are no more occurrences. The matches for the search will be highlighted in the window.						
Replace	Click this button to search for text that matches the found text, and then replace it with the text in the Replace with field.						
Replace All	Replaces all occurrences of the found text with the text in the Replace with field.						
Cancel	Click the button to close the dialog box.						

16.2. Screen Overview

Screen Overview shows the relations between screens of the current application. The relationship between screens is depicted by a line with an arrow head which is called the link. A link is a relationship between screens with the screen button or page selector.

To open the Screen Overview, check the Screen Overview menu item in the View menu. The following is an example of the Screen Overview.

The name of the current panel application. You can select another panel application of the project to view.

The name of the currently selected screen. You can select another screen to highlight the relations of the selected screen.

The number of the currently selected screen. You can select another screen to highlight the relations of the selected screen.

Click the thumbnail of a screen to select that screen and its links.

Click the line between the screens to select that link.

Size of the selected screen; (width x height)

Coordinate of the cursor; (x, y)

Type of the selected item. Could be a Screen/Link

Coordinates of the selected screen; (x, y)













With the selected screen and links, you may do the following:

- Open the screen or screen properties
Double-click the selected screen to open it if it is not already opened.
Double-click the selected screen to open its property sheet if it is not already opened.

- Move the selected screen and its links

Left-click anywhere inside the selected screen and hold down the button. When the cursor changes to , drag the mouse to move the selection to another area of the screen overview window. It will "float" over the rest of the window, allowing you to position it wherever you want it to be. Release the mouse button to "let go" of the selection.

The following table describes each icon in the Screen Overview window.

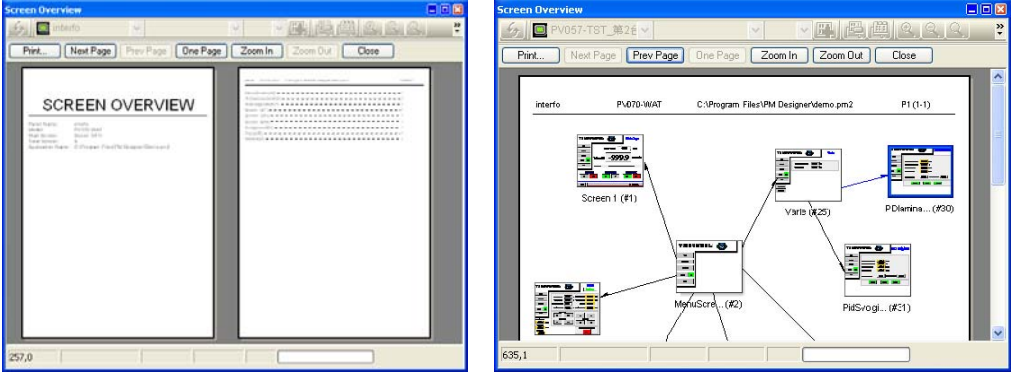
Icon	Tool Tip	Description																
	Refresh	Reload the current content of the screens. Available only when the relations between screens are changed.																
	New Screen	Create a new screen for the current panel application.																
	Add Screen Button Link	Add a new screen button for the selected screen and set up the properties of the screen button in the pop-up properties dialog. Available only when a screen is selected.																
	Add Page Selector Link	Add a new pages selector for the selected screen and set up the properties of the page selector in the pop-up properties dialog. Available only when a screen is selected.																
	Zoom In	Make the screen overview one step bigger.																
	Zoom Out	Make the screen overview one step smaller.																
	Normal Size	Restore the screen overview to normal size.																
	Show Content	Show all the contents of the screens. For example:  Screen 1 (#1)																
	Show Name/Number	Show screen name and screen number in a rectangle to indicate a screen. For example: 																
	Print	Print the application information, screen index and screen overview. The application information includes Panel Name, Model, Start Screen, Total Screens, Application Name. Screen Index is used to list all the screens and the page where the screen is located.																
	Print Preview	<p>Preview the screen overview before printing. The following is examples of the Print Preview Window.</p>  <p>Choose from the following commands to customize your page preview.</p> <table border="1"> <thead> <tr> <th>Click the button</th> <th>To do this</th> </tr> </thead> <tbody> <tr> <td>Print...</td> <td>Set printing options and print the page.</td> </tr> <tr> <td>Next Page</td> <td>Display the next page to be printed.</td> </tr> <tr> <td>Prev Page</td> <td>Display the previous page to be printed.</td> </tr> <tr> <td>One Page</td> <td>Display only one full page in the screen.</td> </tr> <tr> <td>Zoom In</td> <td>Increase the magnification.</td> </tr> <tr> <td>Zoom Out</td> <td>Decrease the magnification.</td> </tr> <tr> <td>Close</td> <td>Close the Print Preview window.</td> </tr> </tbody> </table>	Click the button	To do this	Print...	Set printing options and print the page.	Next Page	Display the next page to be printed.	Prev Page	Display the previous page to be printed.	One Page	Display only one full page in the screen.	Zoom In	Increase the magnification.	Zoom Out	Decrease the magnification.	Close	Close the Print Preview window.
Click the button	To do this																	
Print...	Set printing options and print the page.																	
Next Page	Display the next page to be printed.																	
Prev Page	Display the previous page to be printed.																	
One Page	Display only one full page in the screen.																	
Zoom In	Increase the magnification.																	
Zoom Out	Decrease the magnification.																	
Close	Close the Print Preview window.																	

You can right-click the blank space in the Screen Overview to get the pop-up menu with the following menu items:

Menu Item	Description
New Screen...	Create a new screen for the current panel application and display the screen overview.
Select All	Select all the screens and links.

You can right-click the selected screen to get the pop-up menu with the following menu items:

Menu Item	Description
Add Screen Link...	Add a new screen button for the selected screen and set up the properties of the screen button in the pop-up properties dialog.
Open Screen...	Open the selected screen.
Delete Screen	Delete the selected screen.
Screen Properties...	Open the screen property dialog box of the selected screen.

You can right-click the selected link to get the pop-up menu with the following menu items:

Menu Item	Description
Insert Point	Add a point at the specified position.
Delete Point	Delete a selected point.
Delete Screen Link	Delete the selected link.
Delete Screen Link and Button	Delete the selected link and its associated button.
Screen Link Properties	Set the screen link properties in the following pop-up dialog. <div data-bbox="544 1048 1401 1411" style="border: 1px solid blue; padding: 5px;"> <p>Screen Link Properties</p> <p>Line</p> <p>Style: <input type="text"/> Color: <input type="text"/></p> <p>Button</p> <p><input type="button" value="Properties..."/></p> <p>OK Cancel</p> <p>Click the button to bring up the property sheet of the screen button or page selector for the screen link.</p> </div>

16.3. Link Overview

Link Overview shows the relations between devices/servers and panels of the entire project. The Link Overview is a block and line diagram. The block indicates a target panel or the device/server. The line indicates the link. The line with an arrow header indicates the link relationship.

There are two types of blocks in the link overview window: **Target Panel Block** and **Device/Server Block**. The Target Panel Block includes application Name and supported link ports, such as C stands for COM port (C1 = COM1), E stands for Ethernet port. The Device/Server Block includes the device type.

To open the Link Overview, check the Link Overview menu item in the View menu. The following is an example of the Link Overview.

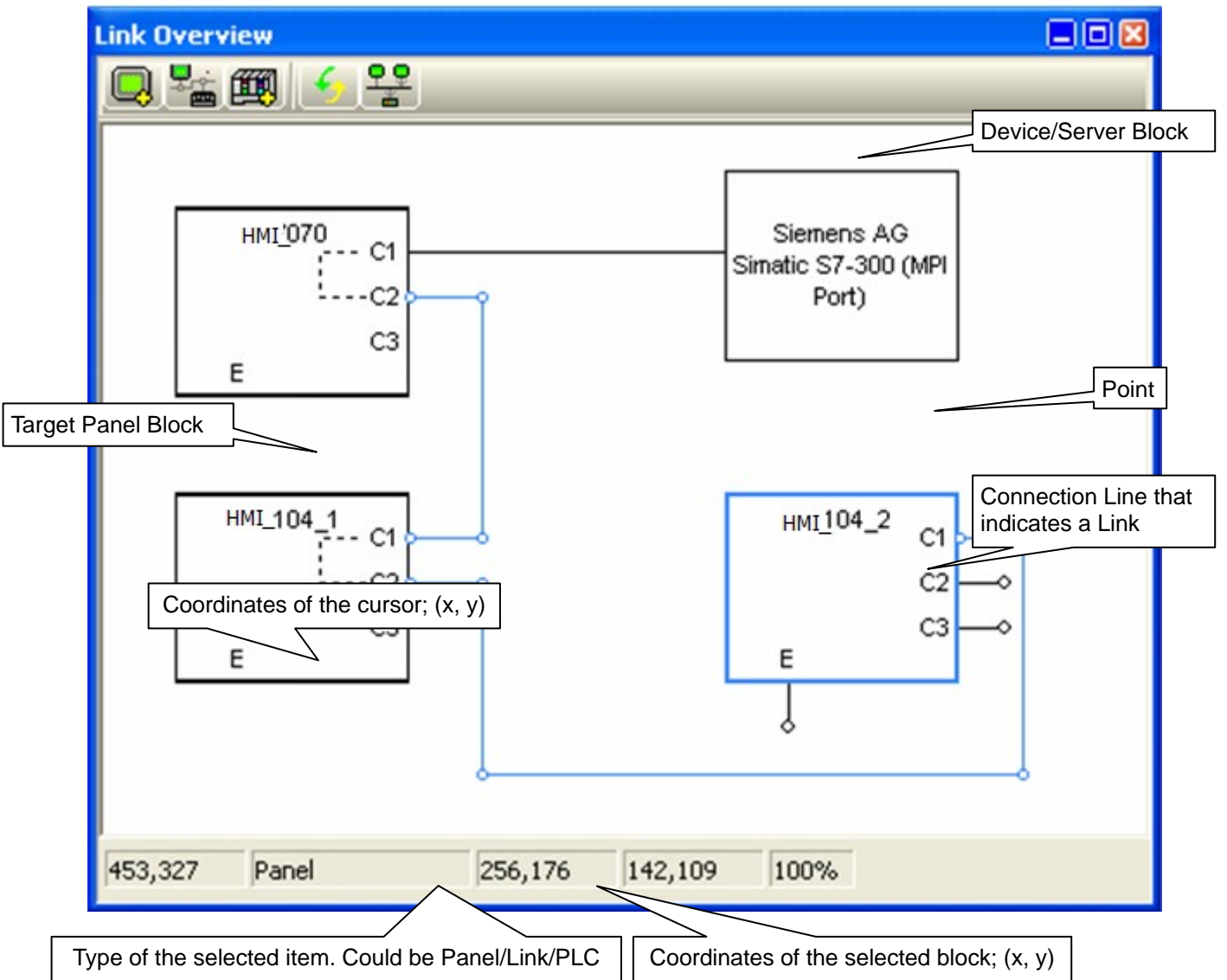

You can position the mouse over a target panel block, a device/server block, or a link to select the related item. With the selected item, you may do the following:

■ **Open the properties dialog to set up item properties**

- Double-click the target panel block to open the General Setup dialog box to set up the panel application.
- Double-click the link to open the Link Properties dialog box to set up the link.
- Double-click the device/server block to open the Link Properties property sheet to select the device for the link.

■ **Move the selected block**

Left-click anywhere inside the selected block and hold down the button. When the cursor changes to , drag the mouse

to move the selection to another area of the link overview window. It will "float" over the rest of the window, allowing you to position it wherever you want it to be. Release the mouse button to "let go" of the selection.

■ Shape the connection line

Position the mouse pointer over one of the points on the selected connection line, drag the point until the connection line is the shape and size you want.

■ Create a link

1. Position the mouse pointer over the point of the communication port. For example:

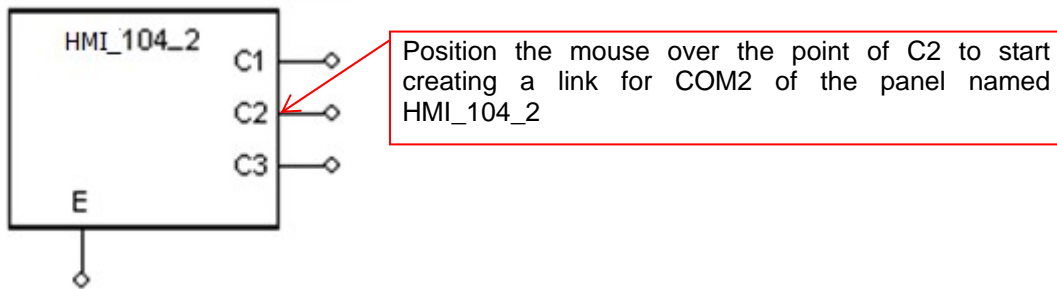

2. Drag the mouse to move the point to the communication port of another panel or device/server. For example:

Drag the point to C3 (COM3) of another panel named HMI_104_1. When the mouse is positioned to HMI_104_1, there are rectangles around its communication ports. The dragged point must be inside the rectangle when creating a link for that port.

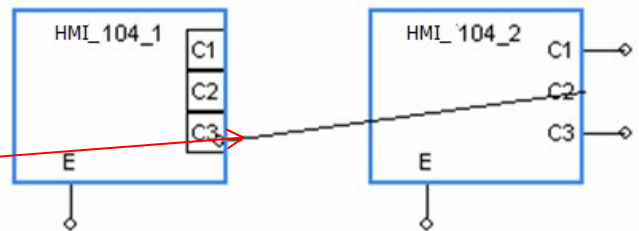



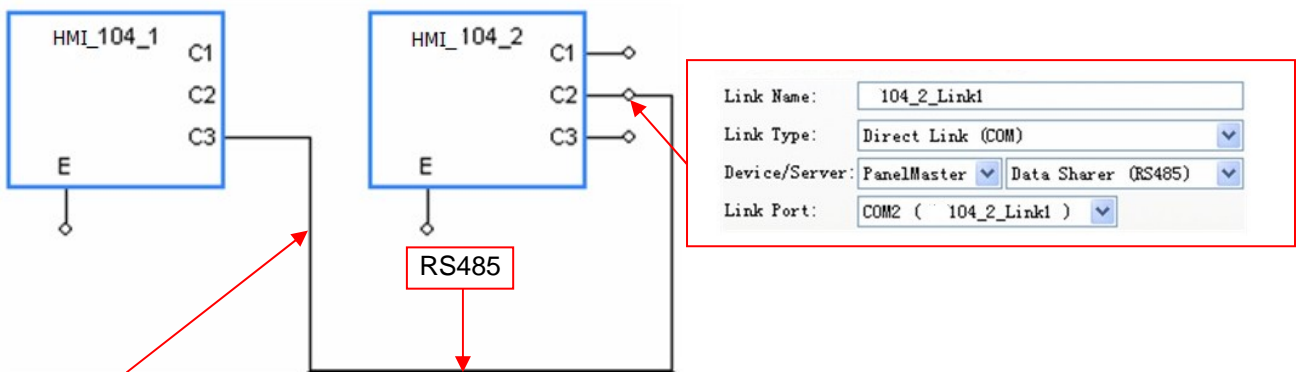

3. Release the mouse button to bring up the Link Properties dialog box to set up the new link.
4. Press the OK button to accept the settings or press the Cancel button to cancel the operations. The following is an example of the new links between two panels.



Link Name: 104_1_Link1
 Link Type: Direct Link (COM)
 Device/Server: PanelMaster Data Sharer (RS485)
 Link Port: COM3 (104_1_Link1)

The following table describes each icon in the Link Overview window.

Icon	Tool Tip	Description
	Add Panel Application	Add a new panel application, set up the panel type and application name in the pop-up property sheet.
	Add Link	Add a new link for the selected panel and set up the link properties in the pop-up property sheet. Only available when the target panel is the current selection.
	Add Device/Server	Add a new Device/Server.
	Refresh	Reload the current relations between panels and the device/server of the project.
	Show Relationship	Display lines with an arrow head to show the relationship between panels and the device/server.

You can right-click the target panel block in the Link Overview to get the pop-up menu with the following menu items:

Menu Item	Description
Add Link	Create a new communication link.
Delete Panel Application	Delete the panel application.
Panel Application Properties	Open the General Setup dialog box.

You can right-click the link in the Link Overview to get the pop-up menu with the following menu items:

Menu Item	Description
Insert Point	Add a point at the specified position.
Delete Point	Delete a selected point.
Delete Link	Delete the associated communication link.
Link Properties	Open the Link Properties dialog box of the associated communication link.

You can right-click the blank place in the Link Overview to get the pop-up menu with the following menu items:

Menu Item	Description
Add Device/Server	Create a new Device/Server
Add Panel Application	Create a new panel application.
Refresh	Reload the current relations between panels and device/server of the project.

You can right-click the Device/Server block in the Link Overview to get the pop-up menu with the following menu items:

Menu Item	Description
Remove Device/Server	Delete the selected Device/Server.
Device/Server Properties	Open the Link Properties dialog box

16.4. Object Library

The Object Library Window is a dockable window. It makes configuring, managing and sharing user-defined objects easier. It contains default objects, common objects, object groups and global objects.

■ Default Objects

Each type of screen objects can have one default object and the default objects are saved in the object library. The settings of a default object will be used as the initial settings for a newly created object of the same type. To view all the default objects for the project, you can click the window tab named Objects.

You are allowed to specify any object as the default object for the type of that object. The old default object of the same type is discarded when you specify a new default object. To make an object as a default object, right-click the object to get the pop-up menu and click the Save as Default command in the pop-up menu.

■ Common Objects/Object Groups

The common object/object group can be used in the whole project. To view the common objects/object groups, you can click the window tab with a user defined name.

To make an object as a common object/object group, right-click the object/object group to get the pop-up menu and click the Save to Object Library... command to bring up the Save to Object Library dialog. In the dialog, you may type a name and select a user defined category for the common object/object group.

■ Global Objects



Global objects can be used in the entire project. Any modification of a global object will be applied everywhere it is used in the project. To view all the global objects for the project, you can click the window tab named Global.

To make an object as a global object, right-click the object to get the pop-up menu and click the Save as Global Object... command to bring up the Save to Object Library dialog. In the dialog, you may type a name and select a user defined category for the global object.

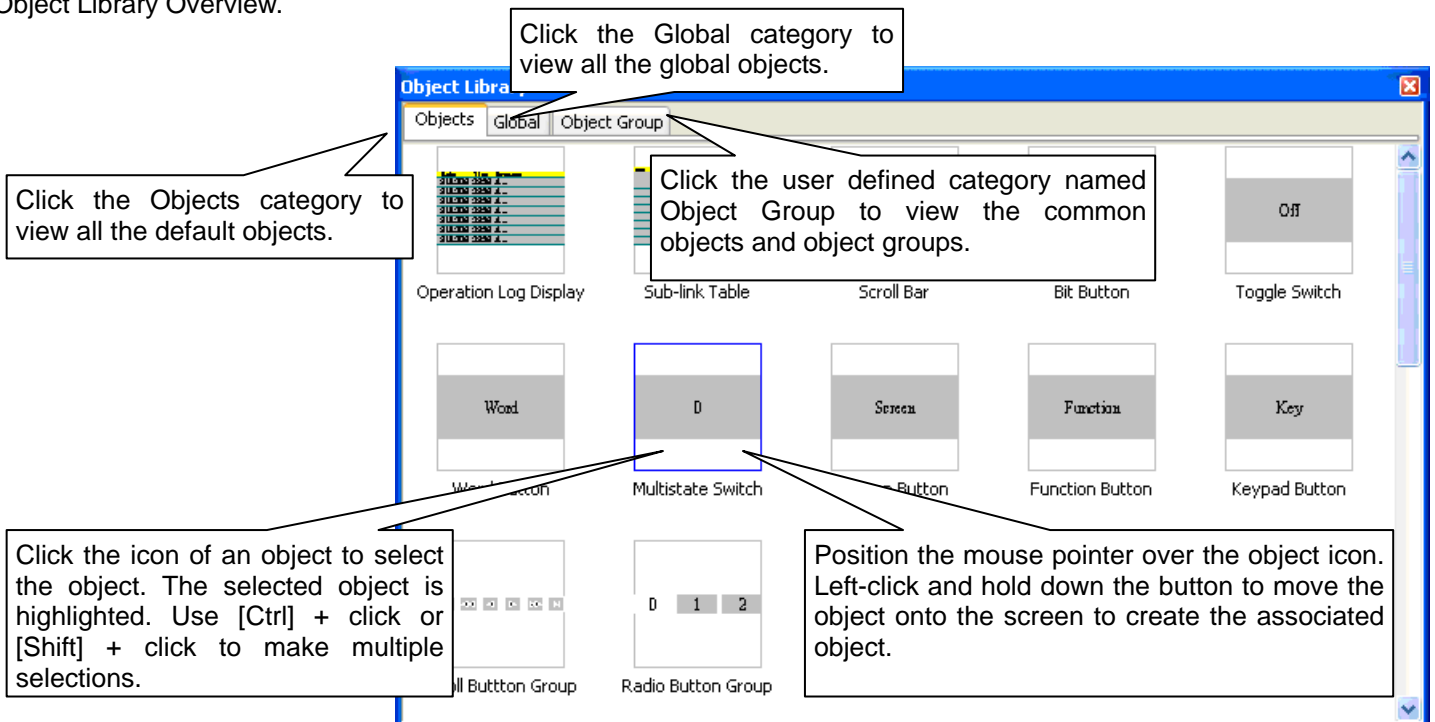
To open the Object Library, check the Object Library menu item in the View menu. The following is an example of the Object Library Overview.



You can right-click the tab on the top of Object Library to get the pop-up menu with the following menu items:

Menu Item	Description
Add Category...	<p>Create a new category for common objects and object groups. The left dialog is an example of the Add Category dialog for you to specify the category name and icon size for displaying the object of the new category.</p> 
Delete Category...	Delete the selected category.
Category Properties...	<p>Click the command to bring up the left sample dialog to set up category properties. You can rename the category in the dialog and define the icon size for the object to be displayed.</p> 
Import Library...	Import an existing category from an object library file (*.pol)
Export Library...	Export a selected category of the object library to an object library file (*.pol)
Clean Unused Data in Library	Click the command to clean all the unused objects in the selected category.

You can right-click the selected object in the Global category window or the user defined category window to get the pop-up menu with the following menu items:

Menu Item	Description
Rename Object...	Click the command to bring up the Rename dialog to rename the selected object.
Delete Selected Objects...	Delete the selected object.
Object Properties...	Click the command to bring up the object properties dialog. Only available in the Global category.

16.5. Object List

The Object List window is a dockable window. It shows the screen objects and the associated I/O addresses.

You can modify the object properties in the Object Property dialog box by double-clicking each entry in the Object List window.

You can right-click anywhere inside the Object List window to get the pop-up menu. In the pop-up menu, check any of the menu items such as ID, Write, Monitor, Read, Notification, TCtrl, VCtrl, and Note to display that column. Use the Select All command in the pop-up menu to display all the columns.

To open the Object List, check the Object List menu item in the View menu. The following is an example of the Object List.

The name of the screen. You can select another screen of the panel application to view its object list.

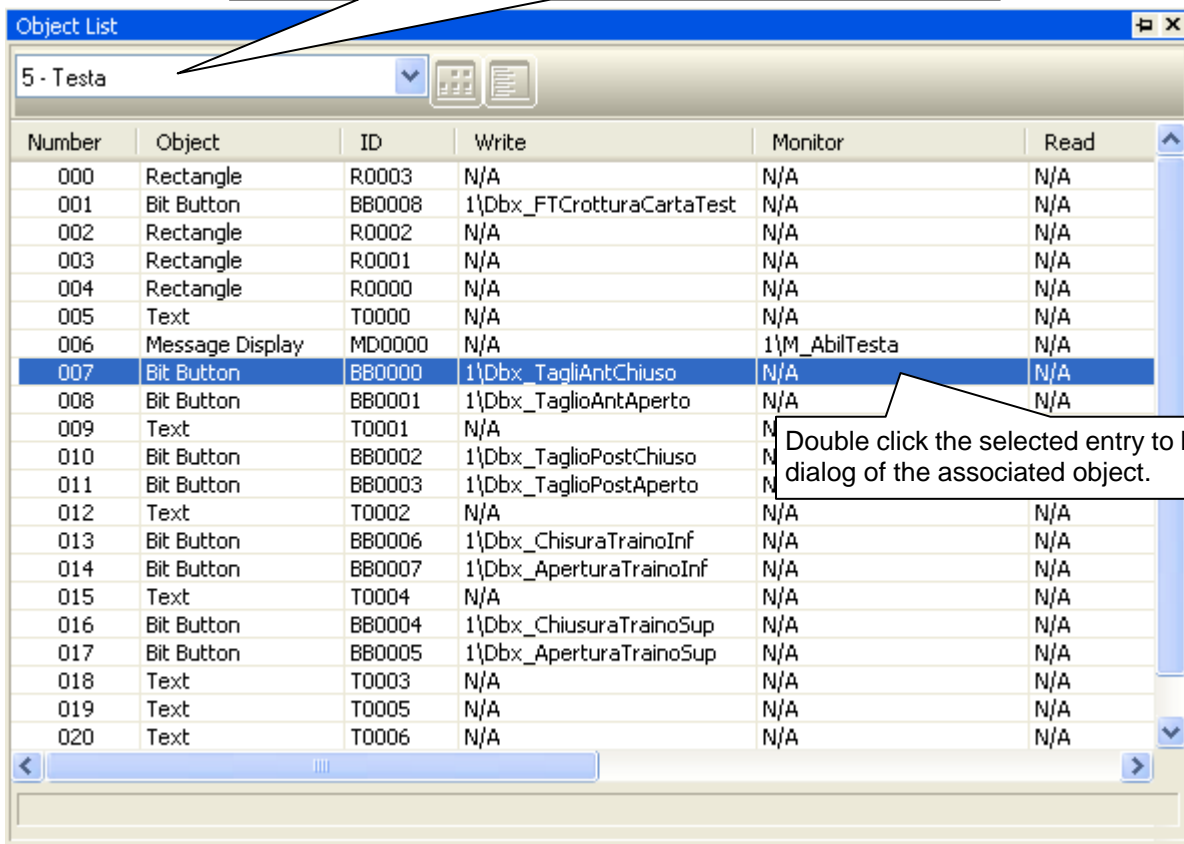

Number	Object	ID	Write	Monitor	Read
000	Rectangle	R0003	N/A	N/A	N/A
001	Bit Button	BB0008	1\Dbx_FTcrotturaCartaTest	N/A	N/A
002	Rectangle	R0002	N/A	N/A	N/A
003	Rectangle	R0001	N/A	N/A	N/A
004	Rectangle	R0000	N/A	N/A	N/A
005	Text	T0000	N/A	N/A	N/A
006	Message Display	MD0000	N/A	1\M_AbilTesta	N/A
007	Bit Button	BB0000	1\Dbx_TagliAntChiuso	N/A	N/A
008	Bit Button	BB0001	1\Dbx_TaglioAntAperto	N/A	N/A
009	Text	T0001	N/A	N/A	N/A
010	Bit Button	BB0002	1\Dbx_TaglioPostChiuso	N/A	N/A
011	Bit Button	BB0003	1\Dbx_TaglioPostAperto	N/A	N/A
012	Text	T0002	N/A	N/A	N/A
013	Bit Button	BB0006	1\Dbx_ChisuraTrainoInf	N/A	N/A
014	Bit Button	BB0007	1\Dbx_AperturaTrainoInf	N/A	N/A
015	Text	T0004	N/A	N/A	N/A
016	Bit Button	BB0004	1\Dbx_ChisuraTrainoSup	N/A	N/A
017	Bit Button	BB0005	1\Dbx_AperturaTrainoSup	N/A	N/A
018	Text	T0003	N/A	N/A	N/A
019	Text	T0005	N/A	N/A	N/A
020	Text	T0006	N/A	N/A	N/A

Double click the selected entry to bring up the property dialog of the associated object.

16.6. I/O List

The I/O list window is a dockable window. It shows all the I/O addresses of the project and their owners.

You can modify the address by double-clicking each entry in the I/O list window.

If the address is used by an object, you can redefine the address in the pop-up property dialog of the associated object.

If the address is used by a Macro, you can change the address in the macro editor window.

You can also click the Address column of the selected entry to type in the address directly.

To open the I/O List, check the I/O List menu item in the View menu. The following is an example of the I/O List.

The name of the current panel application. You can select another panel application of the project to view.

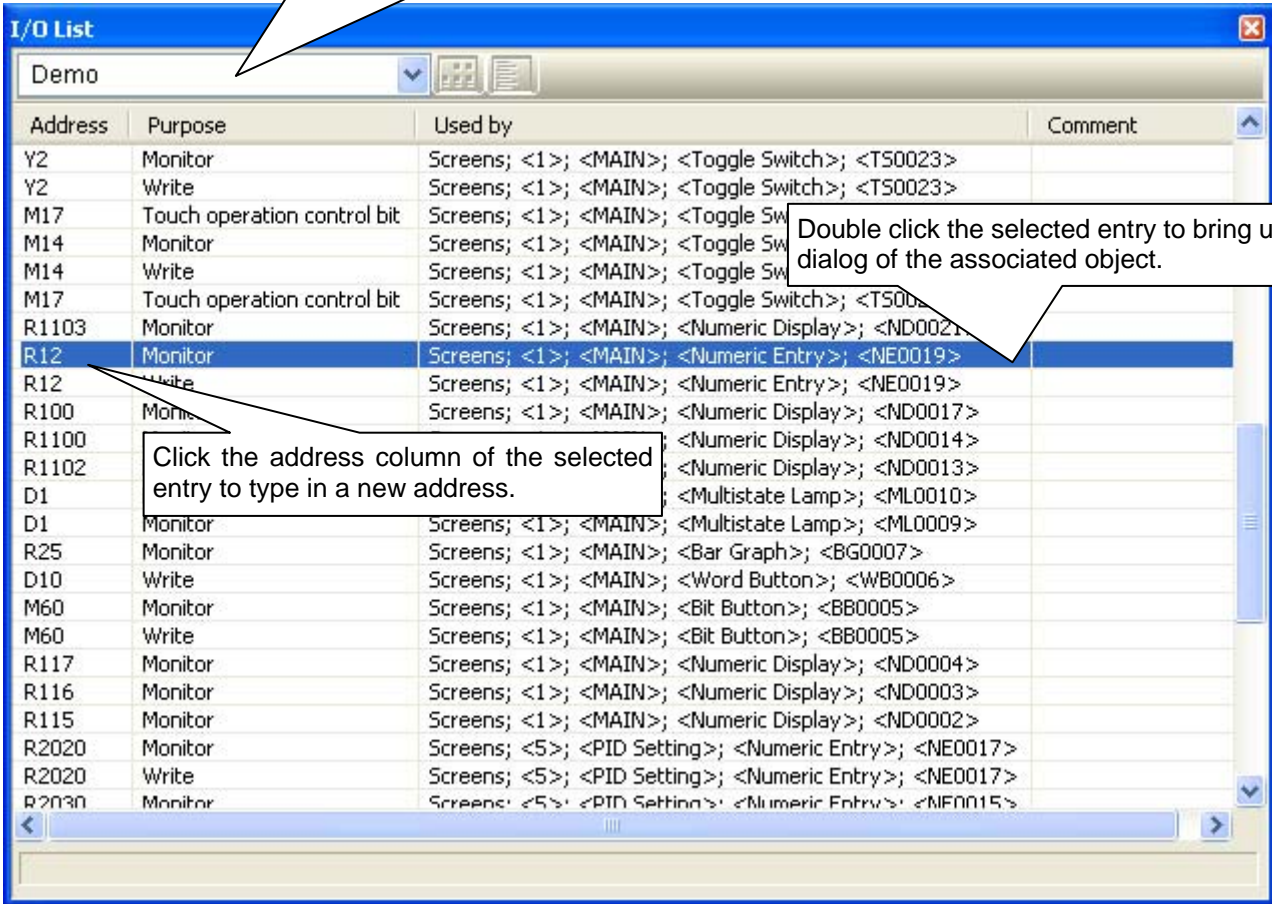

Double click the selected entry to bring up the property dialog of the associated object.

Click the address column of the selected entry to type in a new address.

CHAPTER 17

COMPILING/SIMULATING/DOWNLOADING A PANEL APPLICATION

17.1. Compiling an Application	1
17.1.1. Compiling an Application.....	1
17.1.2. Building a Panel Runtime Package.....	1
17.1.3. Build a List Window	2
17.2. Simulating an Application	3
17.2.1. On-line/Off-line Simulation.....	3
17.2.2. Simulating an Application	4
17.3. Transferring Data Between PC and Panel.....	5
17.3.1. Downloading Data to Panel.....	5
17.3.2. Uploading Data from Panel	7
17.3.3. Installing a USB Driver to Transfer Data Using a USB Cable.....	8

17.1. Compiling an Application

Using the compiler offered by the software, you can verify the correctness of all the settings and designs, optimize the communication with the connected controllers, interpret macros into compact and ready-to-execute codes, and build the panel runtime data to be executed by the HMI engine of the target panel. The panel runtime data will be generated and saved into a PL2 file after the user compiles an application.

17.1.1. Compiling an Application

To compile an application, you can do the following:

- 1) In the menu bar, click Panel to bring up the Panel sub-menu. Click Compile... in the Panel sub-menu.

Alternatively, click the  Compile icon in the main toolbar.

- 2) The Compile Panel Application dialog will pop-up and show the progress of the compiling process. If you want to cancel the compiling operation, click the Cancel button.

On the right is an example of the Compile Panel Application dialog in the process of compiling.

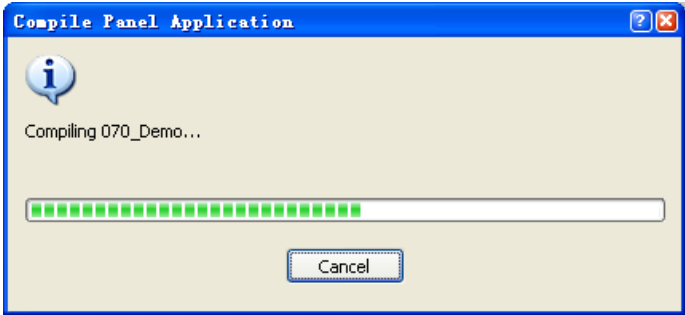

- 3) After the compilation is complete, the Compile Panel Application dialog will display the error count, warning count, and total file size of the panel runtime data. All the details will be listed in the Build List Window. To know about the Built List Window, please see [Section 17.1.3 Built List Window](#).

On the right is an example of the Compile Panel Application dialog when the compilation is complete.

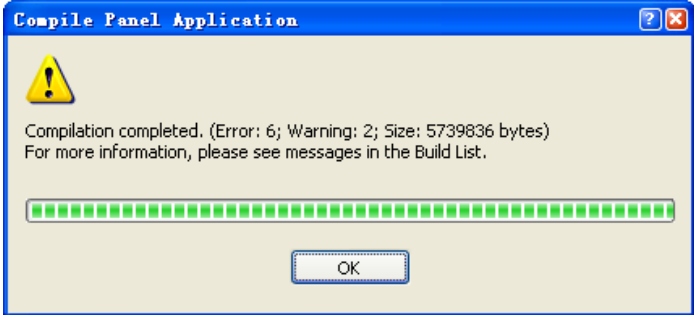

If the compilation is completed successfully, the runtime data of the current panel application will be saved into a file named Project Name_Application Name.pl2.

17.1.2. Building a Panel Runtime Package

A Panel Runtime Package includes the panel runtime data and system programs. To build a panel runtime package, you can do the following:

- 1) In the menu bar, click Panel to bring up the Panel sub-menu. Click Build Panel Runtime Package (PRP)...in the Panel sub-menu.
- 2) If the compilation is completed successfully, you will be asked to specify the file name in the Save As... dialog to save the package into a PRP file.

Note: The PRP file that includes the application and the system programs is portable. You can save the PRP file anywhere on the PC or a USB disk and download it to the target panel with the software or Data Transfer Helper (DTH).

17.1.3. Build a List Window

All the detailed information about the compiling process, error messages, and warning messages are listed in the Build List window. The Build List Window is a dockable window. In the window, error messages will have a red circle in front of the entry, and warning messages will have a yellow circle in front of the entry.

The following is an example of the Build List window:

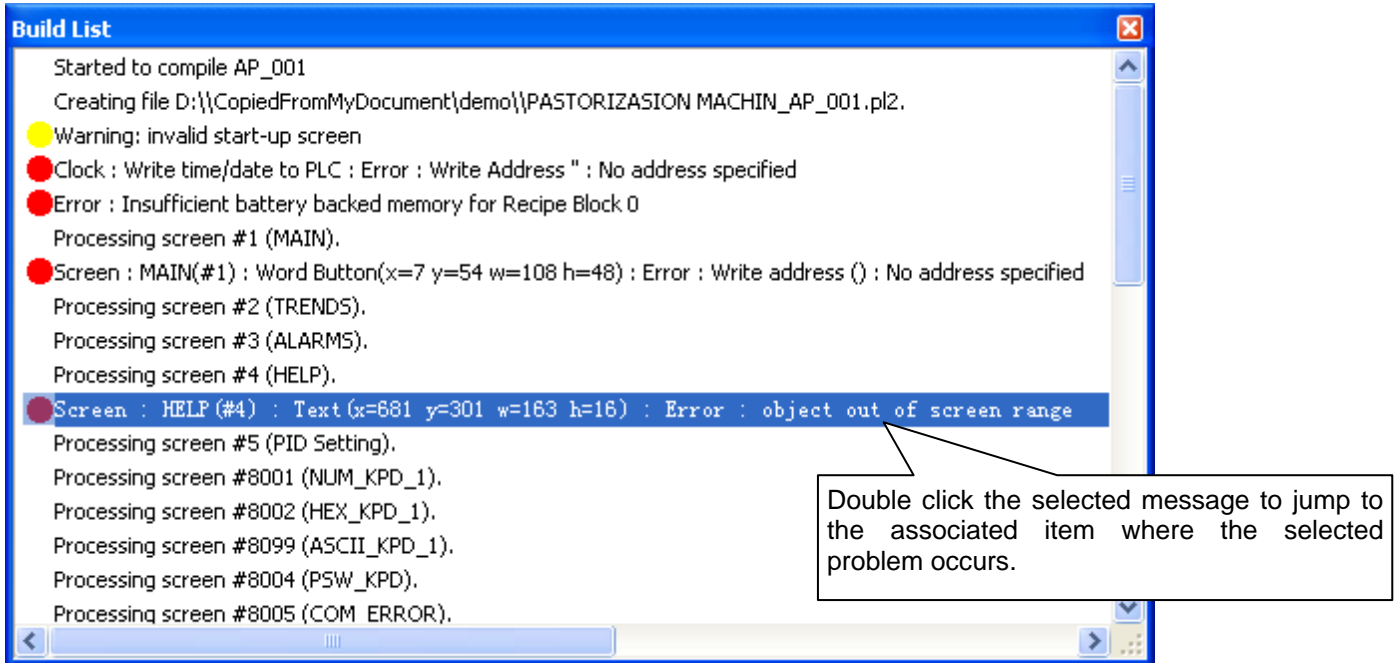

You can right-click the Build List window to get the pop-up menu with the following menu items:

Menu Item	Description
Clear	Clears all the entries in the window.

17.2. Simulating an Application

Simulator is a convenient tool for design verification. With the simulator, you don't need to download the application to the target panel. On a PC, you can simulate how the application runs on the target panel.

There are two types of simulation offered by the software: On-line Simulation and Off-line Simulation.

17.2.1. On-line/Off-line Simulation

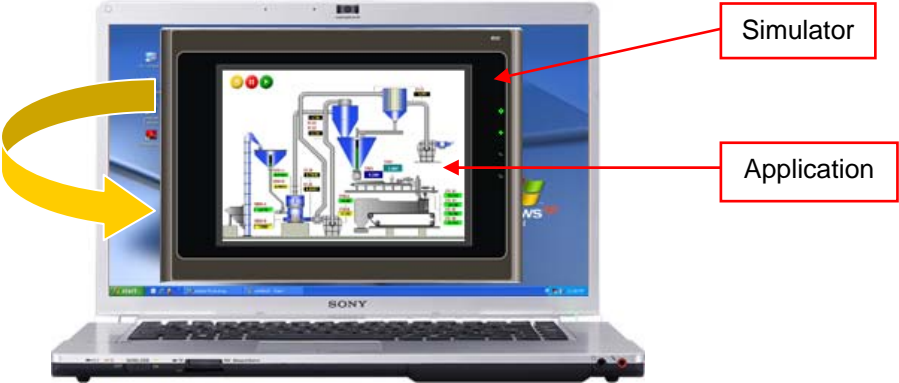
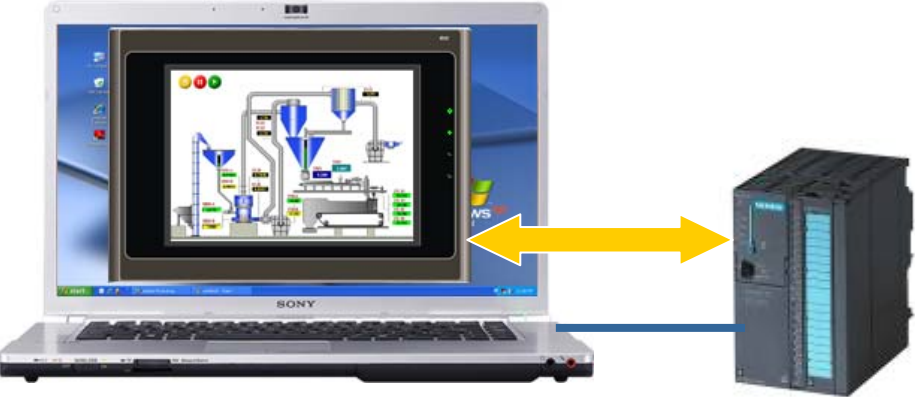
Type	Description
Off-line simulation	 <p>In the off-line simulation mode, the PC will create a memory block for all registers of the device/server used in the application. The simulator will communicate with the memory on the PC, so there will never be a communication error generated with the off-line simulator.</p> <p>Off-line simulation is good for screen visual effects, object operation, and logic verification.</p>
On-line simulation	 <p>The on-line simulator is similar to the off-line simulator except that the PC tries to communicate with the device/server instead of the created virtual registers in its memory.</p> <p>On-line simulator is used to troubleshoot communication problems.</p>

17.2.2. Simulating an Application

To simulate an application, you can do the following:

1) The application must be saved and compiled before the simulator can start.

2) **Using the software:**

In the menu bar, click Tools to bring up the Tools sub-menu. Click Run Off-line Simulation...in the Panel sub-menu.

Alternatively, click the  Run Off-line Simulation icon in the main toolbar.

Using PanelSim.exe, an independent executable program:

Click Start->All Programs->"The software" ->PanelSim

3) In the PanelSim startup dialog, click Run button to start simulation

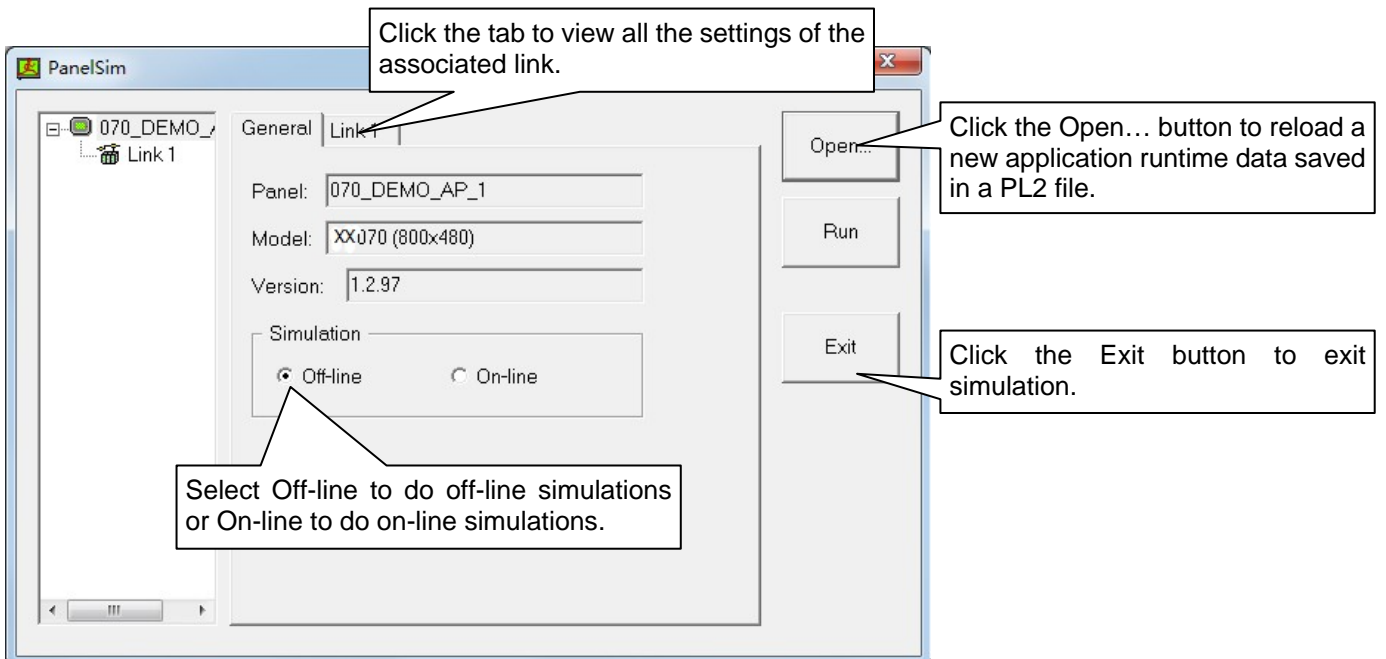

Note: When simulating an application in the software, the above dialog will show up and then close automatically before the simulation starts. In this case, ignore the dialog.

4) Simulate the application in the simulator window. The simulator window is similar in appearance to the target panel. The following is an example of the simulator window while running the application.

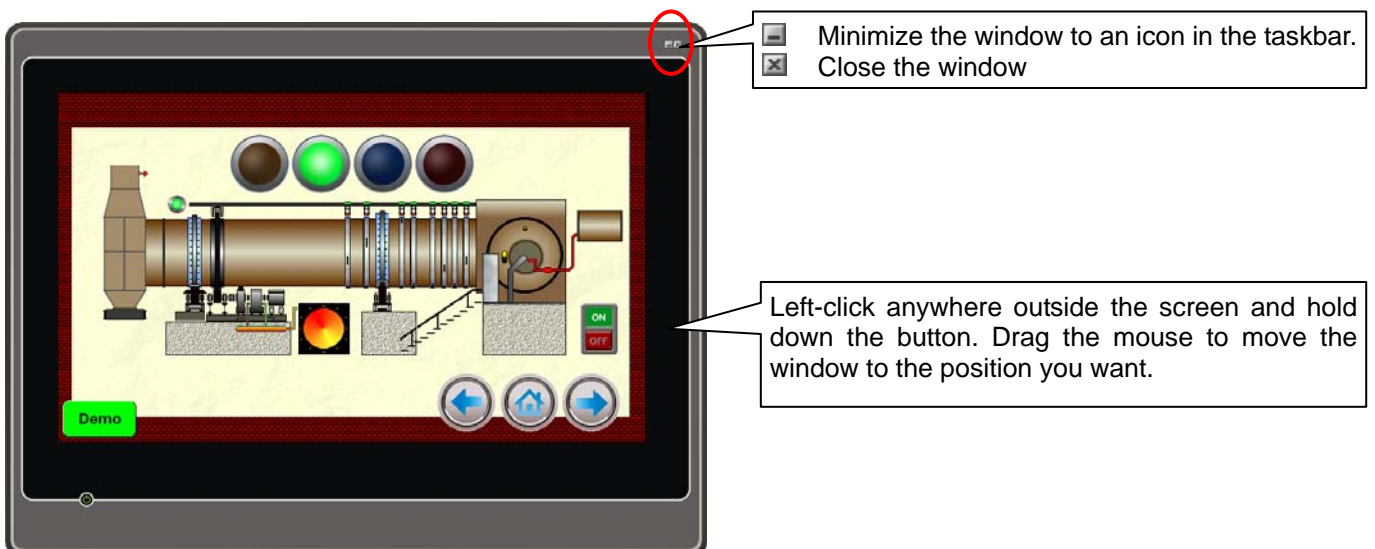

17.3. Transferring Data Between PC and Panel

In the software, you can transfer the panel runtime data using any of the Serial port, Ethernet port or USB client port whenever the target panel is running.

You can also use a Micro SD card or USB memory stick for the trouble-free update of the application.

17.3.1. Downloading Data to Panel

To download data by using the software, you may do the followings:

- 1) In the menu bar, click Panel to bring up the Panel sub-menu. Click Download...in the Panel sub-menu.

Alternatively, click the  Download icon on the standard toolbar.

- 2) In the Download Data to Panel dialog, select the options and settings before downloading.

The following is an example of the Download Data to Panel dialog.

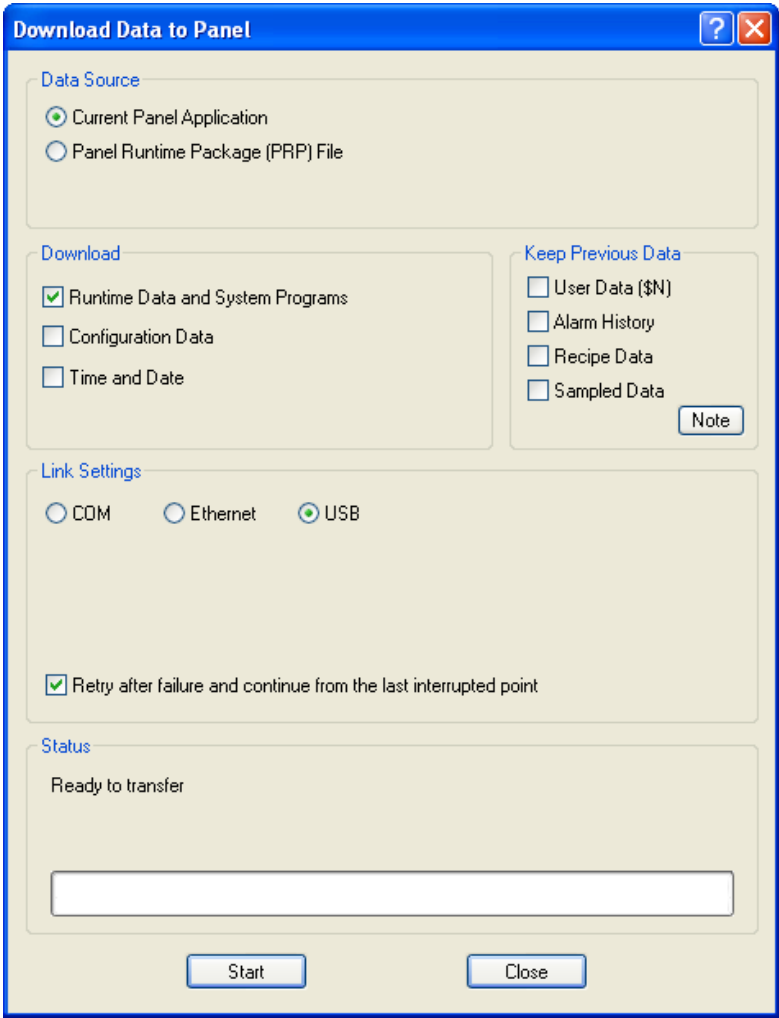

Note: If the application is modified, the software will automatically compile the application before downloading.

The following table describes each property in the Download Data to Panel dialog.

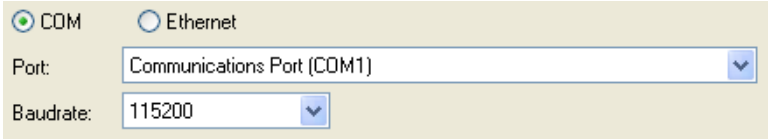
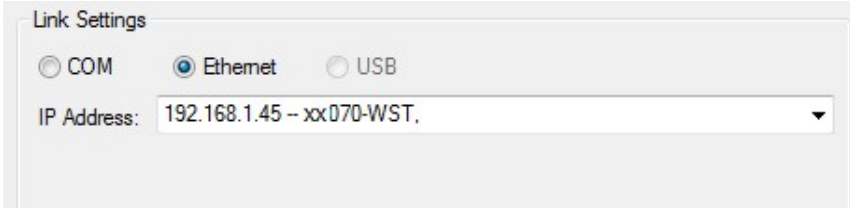
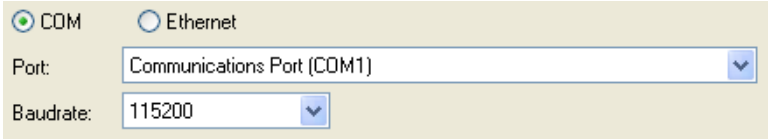
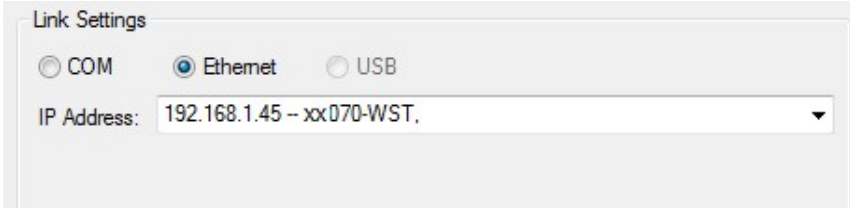
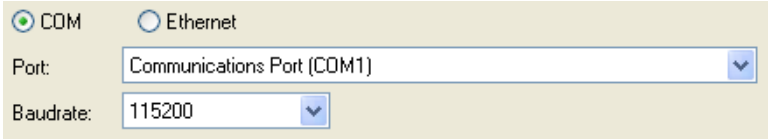
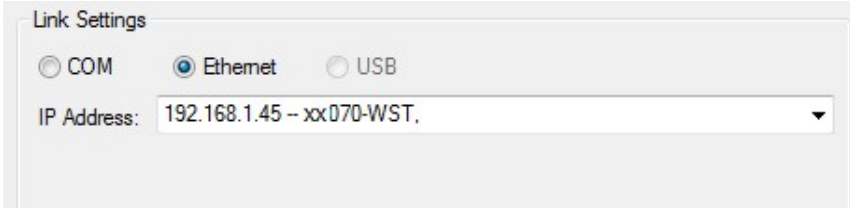
Property	Description														
Data Source	Select the data you want to download. The current panel application is the data generated by the compiler. The panel runtime data package includes the current panel application data and system programs saved in a PRP file. You need to select a PRP file to download if the Panel Runtime Data Package (PRP) File option is selected.														
Download	Check Runtime Data and System Programs, Configuration Data, Time and Date if you want to download them. Available only when the data source is the current panel application. You can select the configuration data to backup the panel application to the target panel. The data format is the same as the Panel Application Files(PLF)														
Keep Previous Data	Check the previous data of User Data (\$N), Alarm History, Recipe Data or Sampled Data if you want the selected data to be kept instead of being cleared after downloading. The selected data will be kept only if: 1) The previous application was compiled and downloaded by the software V1.2.26 or later. 2) The configurations of battery backed user memory, recipe blocks, data loggers, alarm blocks, and the alarm logging buffer for both the old and new applications are exactly the same.														
Link Settings	Select the communication port that is used to download the data. <table border="1" data-bbox="300 770 1497 1451"> <thead> <tr> <th>Communication Port</th> <th>Description</th> </tr> </thead> <tbody> <tr> <td>COM</td> <td>Use the serial port to perform the download and select the communication port and the baud rate used. </td> </tr> <tr> <td>Ethernet</td> <td>Use the Ethernet to perform the download. Type the IP Address where the target panel is located, or choose a recently connected entry from the list. </td> </tr> <tr> <td>USB</td> <td>Use the USB to perform the download. You need to install the USB driver before transferring data with the USB cable. To know how to install a USB driver, please see Section 17.3.3</td> </tr> </tbody> </table> <p>If the target panel has sufficient memory, you can perform data transmission in safe mode.</p> <table border="1" data-bbox="300 1496 1497 1684"> <thead> <tr> <th>Mode</th> <th>Description</th> </tr> </thead> <tbody> <tr> <td>Direct Mode</td> <td>Download data directly to flash memory.</td> </tr> <tr> <td>Safe Mode</td> <td>Buffer the data in the RAM of the target panel to prevent download problems in large files. The transmission has to be done successfully before the data in the SDRAM will be saved to the flash memory.</td> </tr> </tbody> </table>	Communication Port	Description	COM	Use the serial port to perform the download and select the communication port and the baud rate used. 	Ethernet	Use the Ethernet to perform the download. Type the IP Address where the target panel is located, or choose a recently connected entry from the list. 	USB	Use the USB to perform the download. You need to install the USB driver before transferring data with the USB cable. To know how to install a USB driver, please see Section 17.3.3	Mode	Description	Direct Mode	Download data directly to flash memory.	Safe Mode	Buffer the data in the RAM of the target panel to prevent download problems in large files. The transmission has to be done successfully before the data in the SDRAM will be saved to the flash memory.
Communication Port	Description														
COM	Use the serial port to perform the download and select the communication port and the baud rate used. 														
Ethernet	Use the Ethernet to perform the download. Type the IP Address where the target panel is located, or choose a recently connected entry from the list. 														
USB	Use the USB to perform the download. You need to install the USB driver before transferring data with the USB cable. To know how to install a USB driver, please see Section 17.3.3														
Mode	Description														
Direct Mode	Download data directly to flash memory.														
Safe Mode	Buffer the data in the RAM of the target panel to prevent download problems in large files. The transmission has to be done successfully before the data in the SDRAM will be saved to the flash memory.														
Status	Display the transmission status and progress.														
Start	Click the button to start download the data.														
Cancel	Cancel the download operation.														
Close	Exit the dialog.														

Note: On the standard toolbar, you can click the  Download Immediately icon to immediately download data using the existing settings of the Download Data to Panel dialog to the target panel.

17.3.2. Uploading Data from Panel

To upload data using the software, you may do the following:



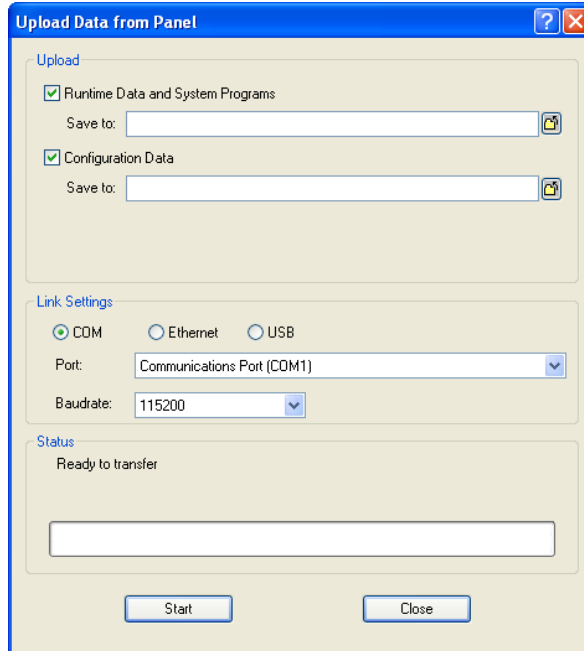

- 1) In the menu bar, click Panel to bring up the Panel sub-menu, then click Upload... in the Panel sub-menu.
- 2) In the Upload Data from Panel dialog, select the options and settings before uploading

The following is an example of the Upload Data from Panel dialog.

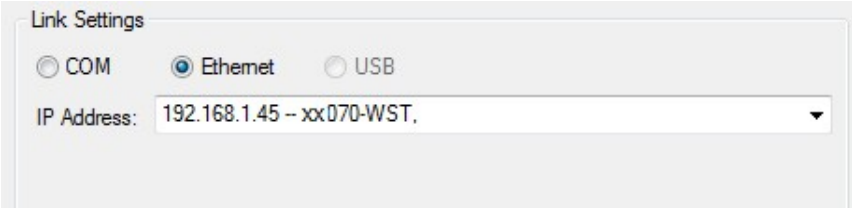

Note: If the application is modified, the software will automatically compile the application before downloading.

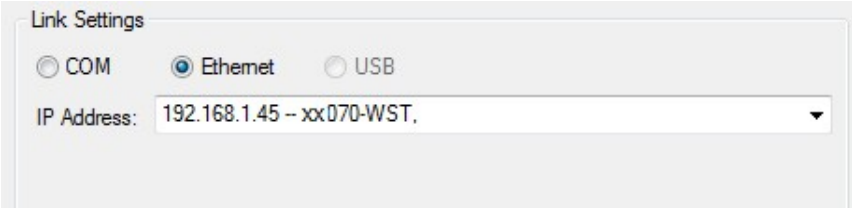
The following table describes each property in the Upload Data from Panel dialog.

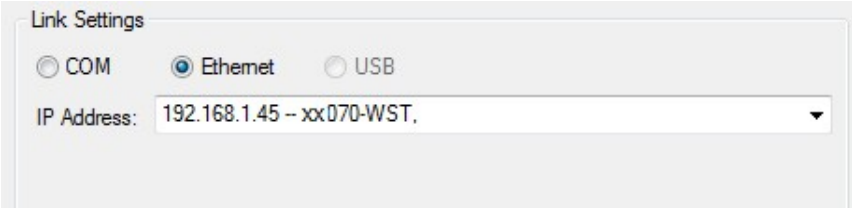
Property	Description								
Upload	Select the data you want to upload and save the uploaded data to the specified file. You can import existing panel applications from the configuration data file (PLF file).								
Link Settings	Select the communication port that is used to upload the data.								
	<table border="1"> <thead> <tr> <th>Communication Port</th> <th>Description</th> </tr> </thead> <tbody> <tr> <td>COM</td> <td>Use the serial port to perform the upload and select the communication port and the baud rate used.  </td> </tr> <tr> <td>Ethernet</td> <td>Use the Ethernet to perform the upload. Type the IP Address where the target panel is located, or choose a recently connected entry from the list.  </td> </tr> <tr> <td>USB</td> <td>Use the USB to perform the upload. You need to install the USB driver before transferring data with the USB cable. To know how to install a USB driver, please see Section 17.3.3</td> </tr> </tbody> </table>	Communication Port	Description	COM	Use the serial port to perform the upload and select the communication port and the baud rate used. 	Ethernet	Use the Ethernet to perform the upload. Type the IP Address where the target panel is located, or choose a recently connected entry from the list. 	USB	Use the USB to perform the upload. You need to install the USB driver before transferring data with the USB cable. To know how to install a USB driver, please see Section 17.3.3
	Communication Port	Description							
COM	Use the serial port to perform the upload and select the communication port and the baud rate used. 								
Ethernet	Use the Ethernet to perform the upload. Type the IP Address where the target panel is located, or choose a recently connected entry from the list. 								
USB	Use the USB to perform the upload. You need to install the USB driver before transferring data with the USB cable. To know how to install a USB driver, please see Section 17.3.3								
Status	Display the transmission status and progress.								

Start	Click the button to start uploading the data.
Cancel	Cancel the upload operation.
Close	Exit the dialog.

17.3.3. Installing a USB Driver to Transfer Data Using a USB Cable

This section describes how to install a USB driver for downloading an application to the target panel on a Microsoft Windows based computer.

Step 1: Log on to your computer as an administrator.

Step 2: Connect the computer and the target panel through a USB cable

Step 3: Start installing the driver

You can use one of the following methods as appropriate to begin installing the driver:

■ **With the Found New Hardware Wizard**

Power on the target panel, “Found New Hardware Wizard” will automatically pop-up in Windows to guide you to install the driver.



■ **With the Upgrade Device Driver Wizard**

If the “Found New Hardware Wizard” does not appear or if it is turned off, you can do the followign to bring out the Upgrade Device Driver wizard:

1. On the desktop, right-click **My Computer**, and then click **Manage**.
2. Under **System Tools**, click **Device Manager**.
The devices that are installed on the computer are listed in the right pane.
3. Expand the **Other devices** category
4. Right-click the device named **Neo HMI** for which you want to install the driver, and then click **Properties**.

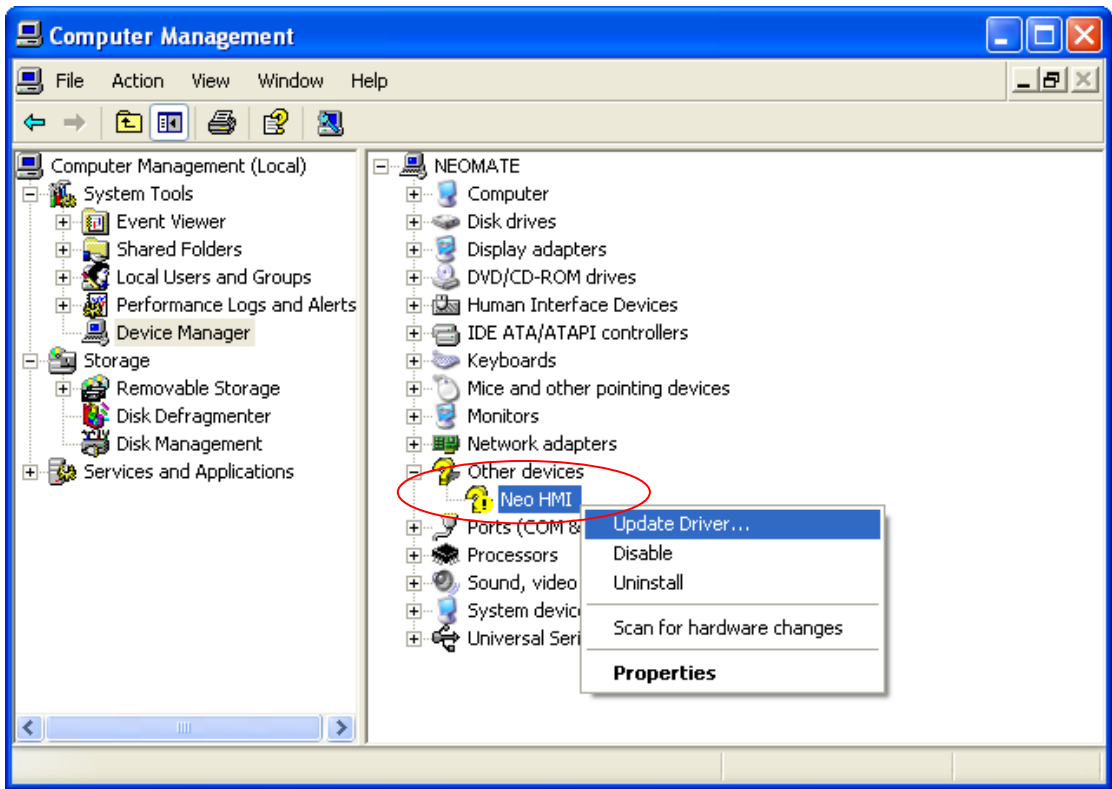

5. Click the **Driver** tab, and then click **Update Driver**. The Upgrade Device Driver wizard starts.

Step 4: Install the driver by following the wizard instructions

1. Click **Next**.



2. Click **Install from a list or specific location (Advanced)**, and then click **Next**.

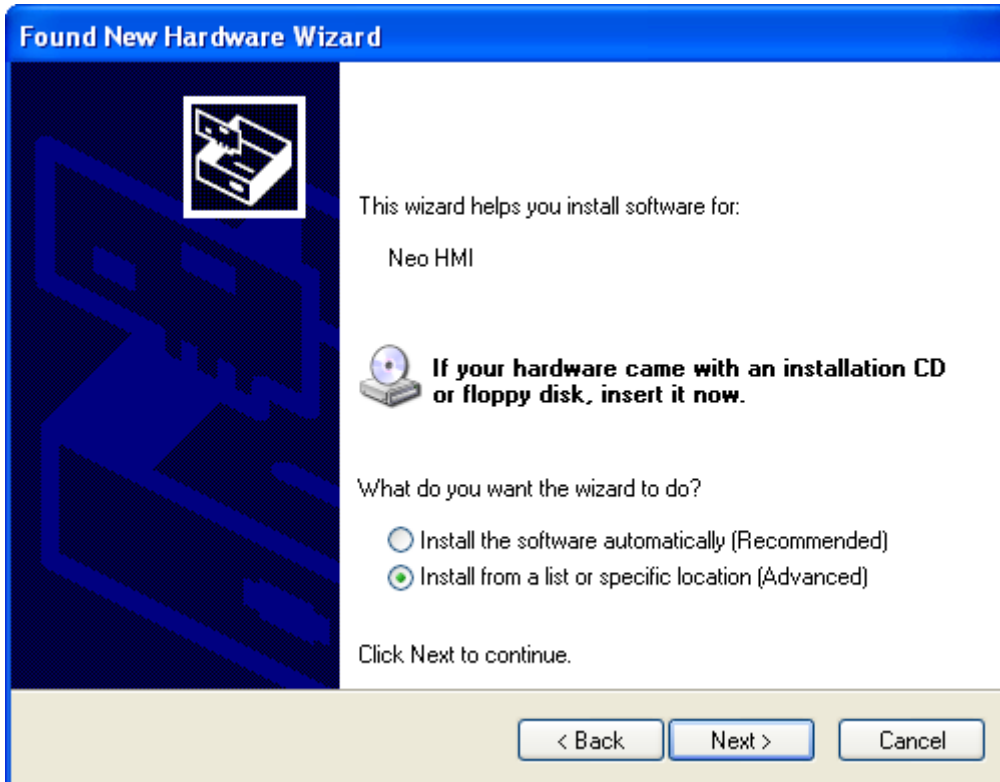

3. Click **Search for the best driver in these locations**, and then select **Include this location in the search**, click Browse, select \usb in the software's installation folder as the folder that contains drivers, and then click **Next**.
4. Click **Continue Anyway** if the Hardware Installation dialog box shown as below appears.



Step 5: Click Finish to complete installing the driver for Neo HMI



Note: The first time you connect a target panel that plugs into any of the USB ports on the computer, you need to install a driver for that device.

After installing the driver, you can use the USB to transfer data between the PC and the target panel which supports USB transferring. In the software, you need to select USB as the link settings in the Download Data to Panel/Upload Data from Panel dialog box before transferring.

CHAPTER 18

USING TOOLS

18.1. Setting/Starting/Ending Transparent Communication.....	1
18.1.1. Setting Transparent Communication	1
18.1.2. Starting/Ending Transparent Communication	2
18.2. Data Transfer Helper (DTH)	3
18.2.1. Operation Settings	4
18.2.2. Operation Status.....	8
18.2.3. Time Range.....	9
18.3. TextEditor.....	10
18.3.1. Exporting Text.....	10
18.3.2. Importing Text.....	11
18.3.3. TextEditor.....	12
18.4. Recipe Editor	13

18.1. Setting/Starting/Ending Transparent Communication

Transparent communication is a serial port communication method used to link a PC and a device/server for control and data acquisition through a target panel, as shown below. The target panel in the link is just like a transparent device that makes the communication work as if a PC is connected to the device/server directly.

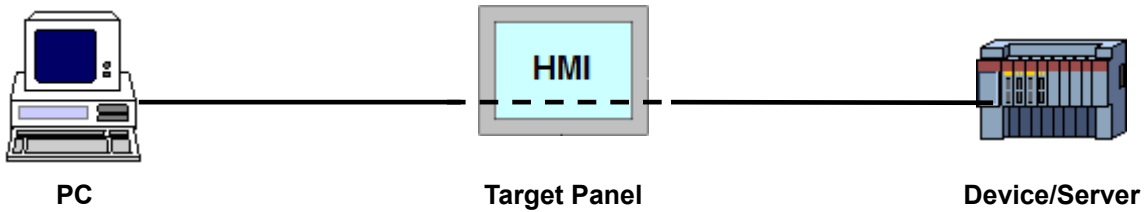

18.1.1. Setting Transparent Communication

To make the target panel transparent and acquire or control the device data on the PC, you need to set Transparent Communication.

To set Transparent Communication, click Tools to bring up the Tools sub-menu in the menu bar. Then, click Set Transparent Communication...in the Tools sub-menu.

The following is an example of a link illustration and Set Transparent Communication dialog.

The diagram shows an HMI connected to a PC and a FATEK FBs/FBe. Callouts identify the 'PC Port (COM1)', 'Panel's Transparent Port (COM1)', and 'Panel's Target Port (COM2)'. The PC is labeled 'PC (9600/7/1/EVEN)' and the FATEK device is 'FATEK FBs/FBe (9600/7/1/EVEN)'. The 'Set Transparent Communication' dialog box is shown with the following settings:

- Link Settings: PC Port: Communications Port (COM1)
- Panel's Transparent Port: COM1
- Panel's Target Port: COM2
- Target Port Settings: Link Name: Link 1; Controller Brand Name: Fatek Automation Corp.; Controller Model Name: FATEK FBs/FBe
- Baudrate: 9600; Data bits: 7; Stop bits: 1; Parity check: EVEN

Buttons include 'Get Info. from Panel via PC Port', 'Start Transparent Communication', 'End Transparent Communication', 'OK', and 'Cancel'. A note states: 'Note that the communication parameters setting in the dialog must be identical to the communication parameters of the Device/Server.'

If the target panel has an application with the link settings that are exactly the same as the real connection between the target panel and a Device/Server, the user only needs to press  button to get all the communication parameters from the panel before starting the transparent communication.

The following is an example of the link settings between the target panel and a Device/Server

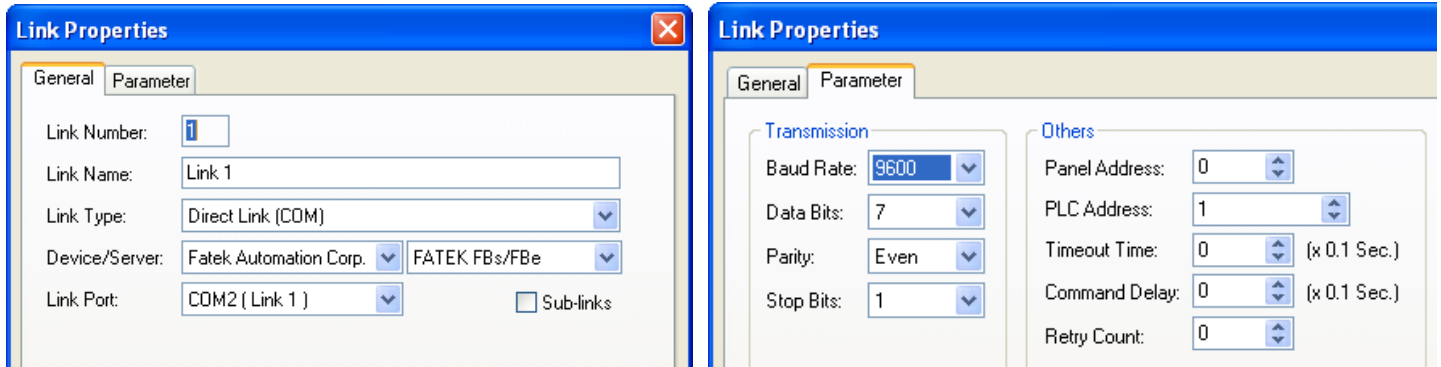

Note: The communication parameters setting in the Link Properties dialog must be identical to the communication parameters of the Device/Server.

If the target panel has no application or if the link settings are not the same as the actual connection, the user needs to redefine the communication parameter in the dialog before starting the transparent communication.

18.1.2. Starting/Ending Transparent Communication

■ Start Transparent Communication

To start transparent communication, you can do one of the following:

- 1) Click the  button in the Set Transparent Communication dialog
- 2) Click Tools to bring up the Tools sub-menu from the menu bar. Then, click Start Transparent Communication in the Tools sub-menu.

If communication is successfully established, the target panel will display the following dialog, and then you can control and acquire the device data with the PC.

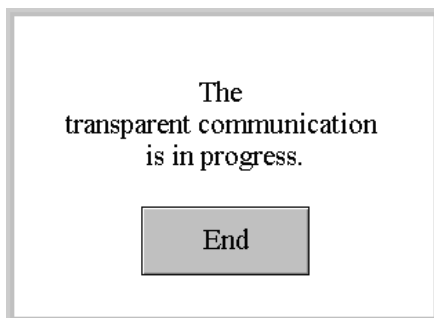

■ End Transparent Communication

To end transparent communication, you can do one of the following:

- 1) Click the  button in the Set Transparent Communication dialog in the software.
- 2) Click Tools to bring up the Tools sub-menu in the menu bar. Then, click End Transparent Communication in the Tools sub-menu.
- 3) Click the End button on the dialog that is shown on the target panel

18.2. Data Transfer Helper (DTH)

Data Transfer Helper (DTH) is an independent executable program. It helps you retrieve/update application data through a serial port or Ethernet port

To run the DTH, choose Start > All Programs > "The software" >  Data Transfer Helper (DTH).

You can use DTH to download recipe data or OS & AP in a specified file from the PC to the HMI. With DTH, you can also get logged data, logged operations, alarm counts, logged alarms, recipe data, OS & AP from the HMI, and save the data in a specified file on the PC. The following dialog is an example of the Data Transfer Helper:

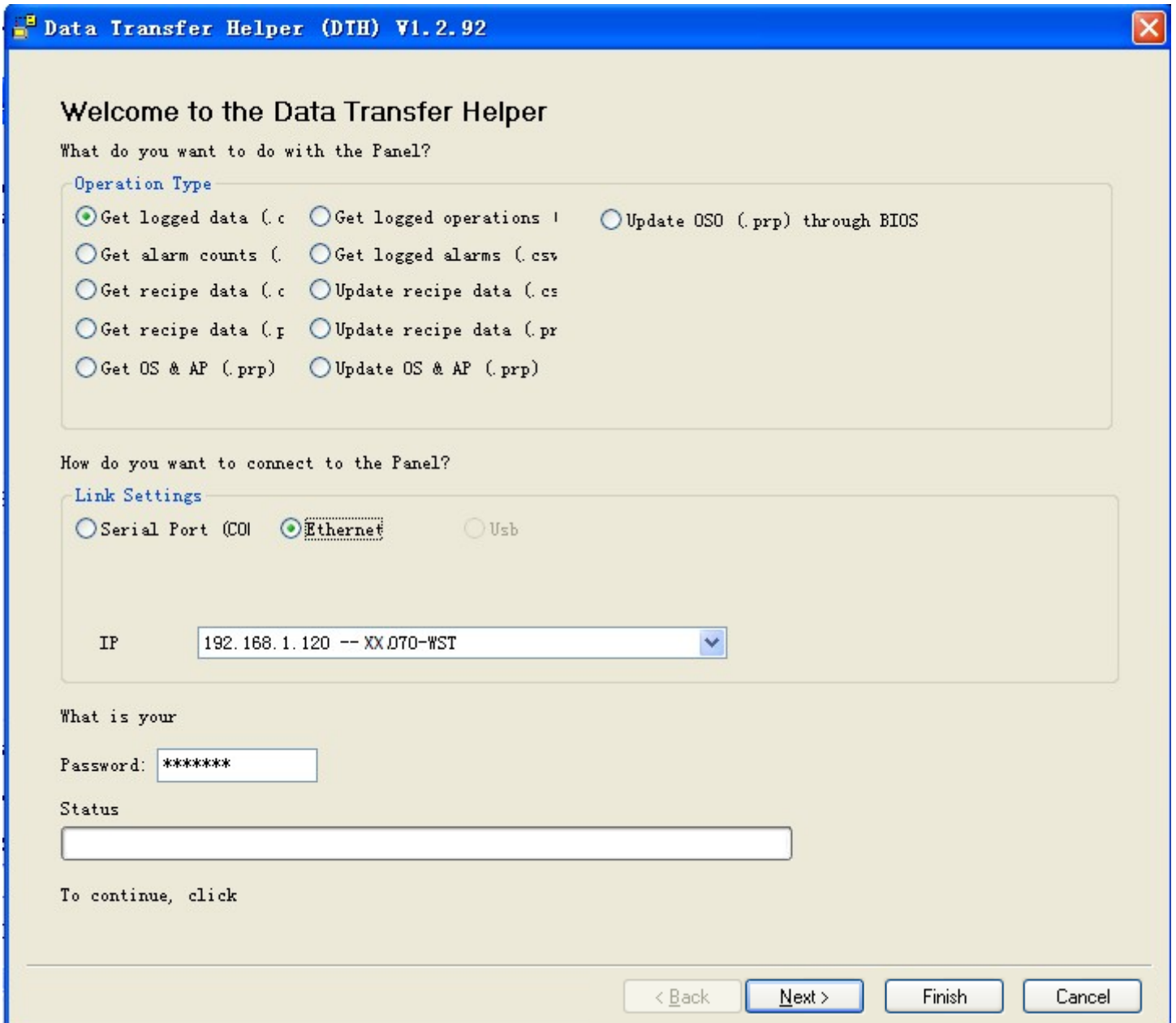

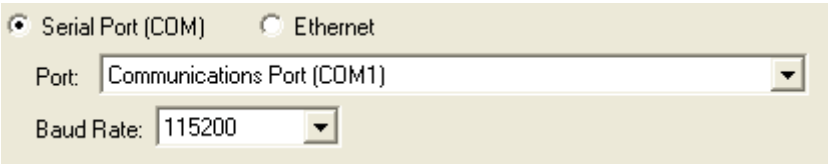
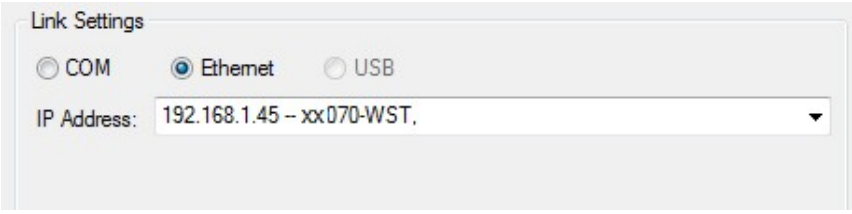
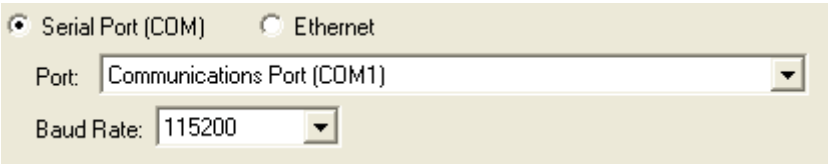
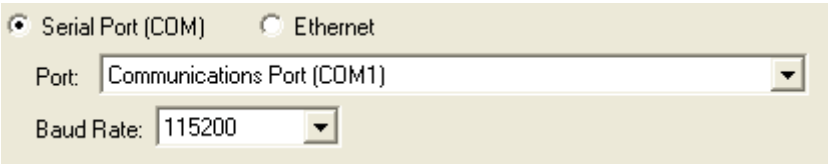
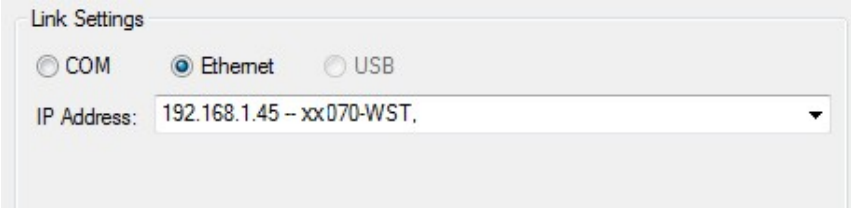

The following table describes each property in the Download Data to Panel dialog.

Property	Description					
Operation Type	Select an operation you want to perform with the target panel					
Link Settings	Select the communication port that is used to connect to the target panel.					
	<table border="1"> <thead> <tr> <th>Communication Port</th> <th>Description</th> </tr> </thead> <tbody> <tr> <td>Serial Port (COM)</td> <td>Use the serial port to perform the operation and select a communication port and the baud rate used.  </td> </tr> <tr> <td>Ethernet</td> <td>Use the Ethernet to perform the operation. Type the IP Address where the target panel is located, or choose a recently connected entry from the list.  </td> </tr> </tbody> </table>	Communication Port	Description	Serial Port (COM)	Use the serial port to perform the operation and select a communication port and the baud rate used. 	Ethernet
Communication Port	Description					
Serial Port (COM)	Use the serial port to perform the operation and select a communication port and the baud rate used. 					
Ethernet	Use the Ethernet to perform the operation. Type the IP Address where the target panel is located, or choose a recently connected entry from the list. 					
Password	Enter a valid password of user level 8 or higher					
Status	Display the transmission status and progress.					
Abort	Stop the communication					
Next	Click the button to start the operation and do the settings for the selected operation if communication is established successfully.					
Finish	Exit the dialog.					
Cancel	Cancel the operation.					



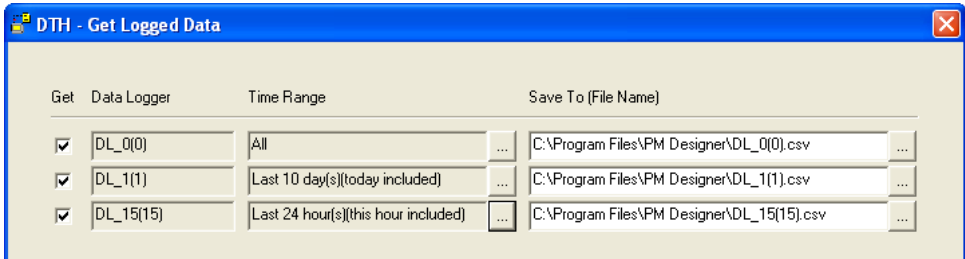

18.2.1. Operation Settings

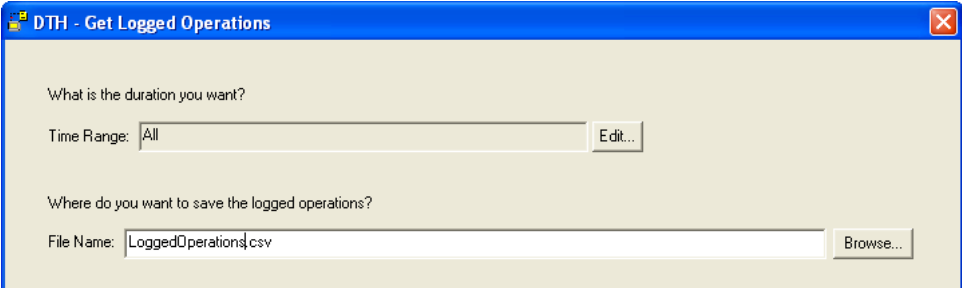
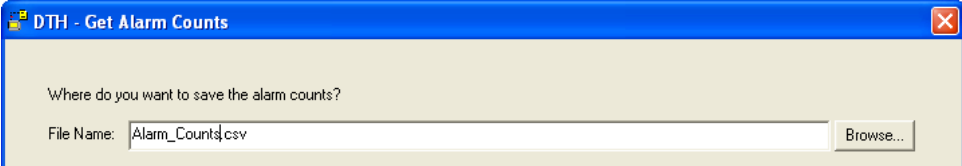
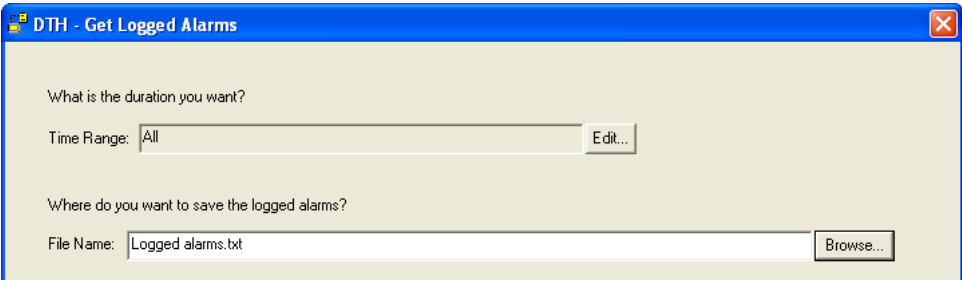
The following table lists all the operation types supported by DTH and shows how to make the settings for each type.

Operation Type	Settings
Get logged data (.csv/.txt)	<p>Saves the data collected by the selected data logger in a specified file.</p>  <p>The above dialog lists all the data loggers in the application. You may do the following in the dialog:</p> <ul style="list-style-type: none"> • Check the data logger you want to get the data from. • Click  button in Time Range to bring up the Time Range dialog to specify the duration of the collected data. For more about the Time Range dialog, please see Section 18.2.3. • Type in a file name or click  button of Save To (File Name) to bring up the Open File dialog to specify the file name.

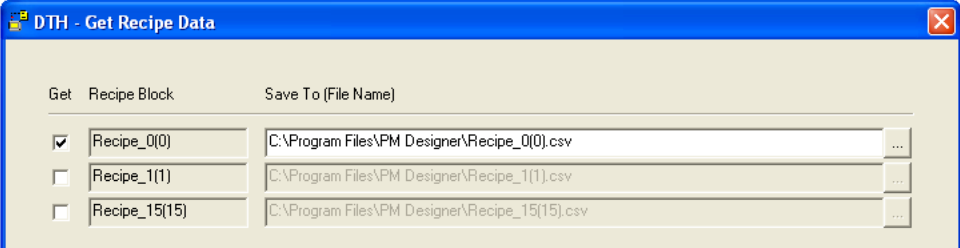
Operation Type	Settings
Get logged operations(.csv/.txt)	<p>Saves the operation history in a text file or a csv file.</p>  <p>You need to do the following in the dialog:</p> <ul style="list-style-type: none"> • Click Edit... button to bring up the Time Range dialog to specify the duration of the operation history data. For more about the Time Range dialog, please see Section 18.2.3. • Type in a file name or click Browse... button to bring up the Open File dialog to specify the file name.
Get alarm counts(.csv/.txt)	<p>Saves the alarm counts in a text file or a csv file.</p>  <p>Type in a file name or click Browse... button to bring up the Open File dialog to specify the file name in CSV or TXT format</p>
Get logged alarms(.csv/.txt)	<p>Saves the alarm history in a text file or a csv file.</p>  <p>You may do the following in the dialog:</p> <ul style="list-style-type: none"> • Click Edit... button of Time Range to bring up the Time Range dialog to specify the duration of the alarm history data. For more about the Time Range dialog, please see Section 18.2.3. • Type in a file name or click Browse... button to bring up the Open File dialog to specify the file name.

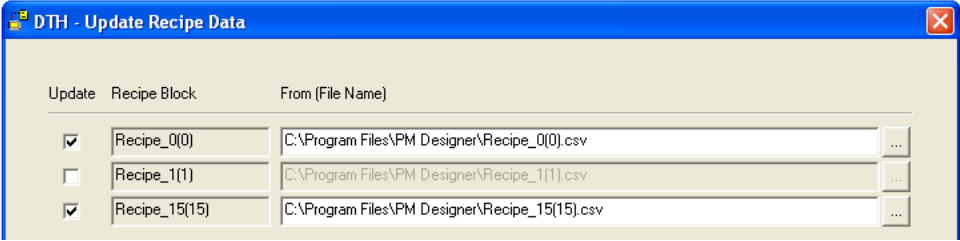
Continued

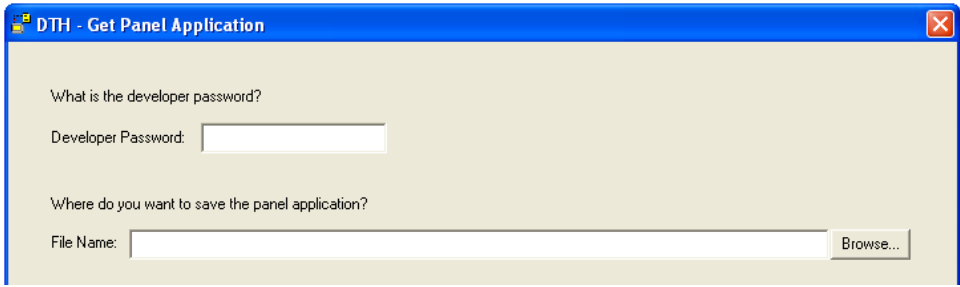
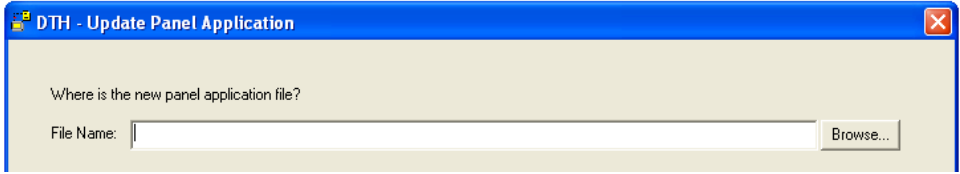
Operation Type	Settings
Get recipe data(.csv/.txt/.prd)	<p>Saves the data of the specified recipe block in a file using the CSV/TXT/PRD format.</p>  <p>The above dialog lists all the recipe blocks in the application. You may do the following in the dialog:</p> <ul style="list-style-type: none">• Check the recipe block you want to get the data from.• Type in a file name or click  button of Save To (File Name) to bring up the Open File dialog to specify the file name.
Update recipe data(.csv/.txt/.prd)	<p>Updates the data of the selected recipe block from a CSV or TXT or PRP file.</p>  <p>The above dialog lists all the recipe blocks in the application. You may do the following in the dialog:</p> <ul style="list-style-type: none">• Check the recipe block you want to update the data of.• Type in a file name or click  button of Save To (File Name) to bring up the Open File dialog to specify the file name.
Get OS & AP (.prp)	<p>You need to enter a valid developer password to get and save the system programs and application runtime data in a specified PRP file..</p> 
Update OS & AP(.prp)	<p>Updates the system programs and the application runtime data from a specified PRP file. The original system programs and the application runtime data are replaced by the new ones.</p> 

18.2.2. Operation Status

All the operation history and status will be shown in the Operation Status dialog. The following is an example of the Operation Status dialog.

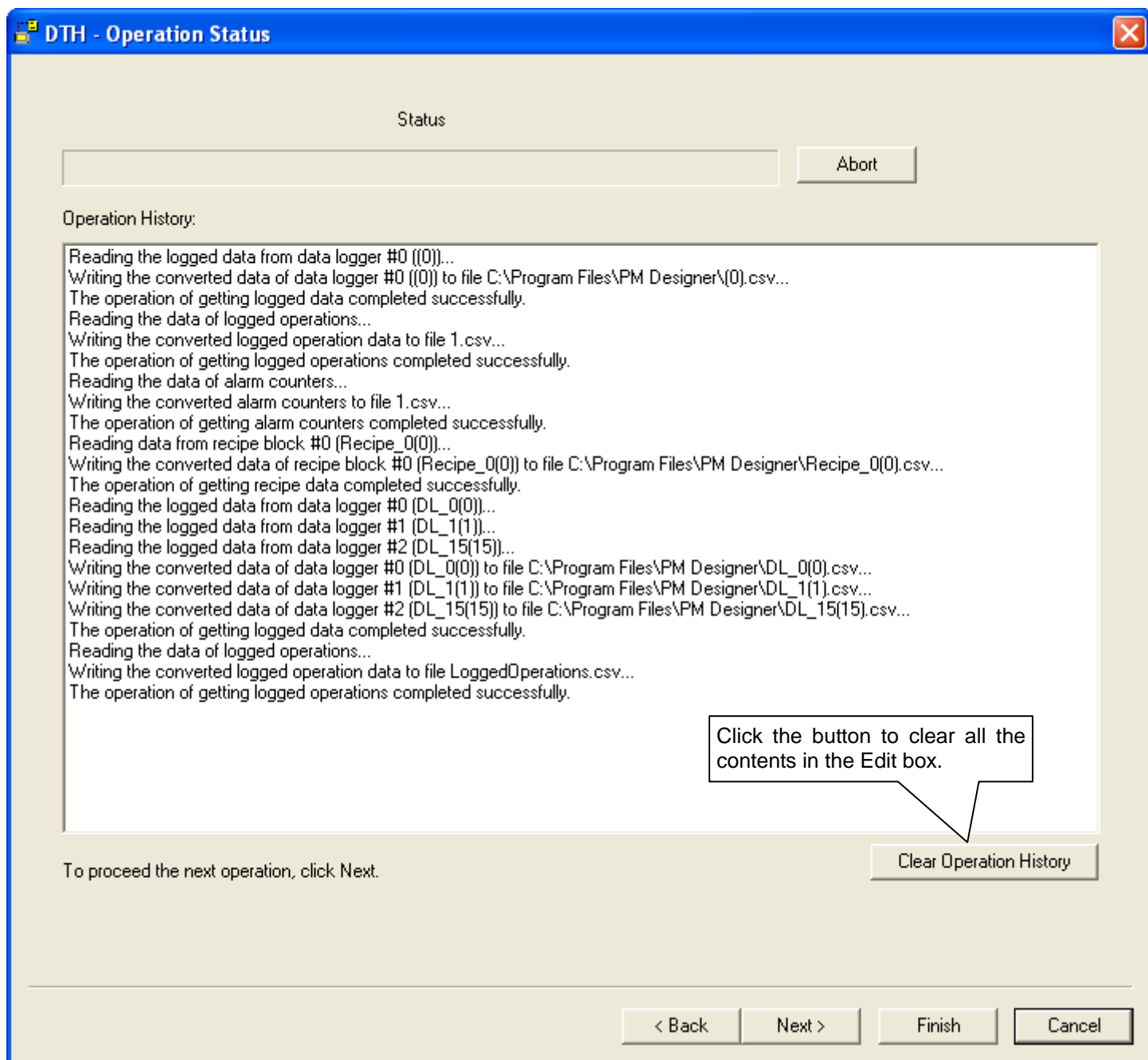

18.2.3. Time Range

The Time Range dialog is used to set up the time duration of the collected data.

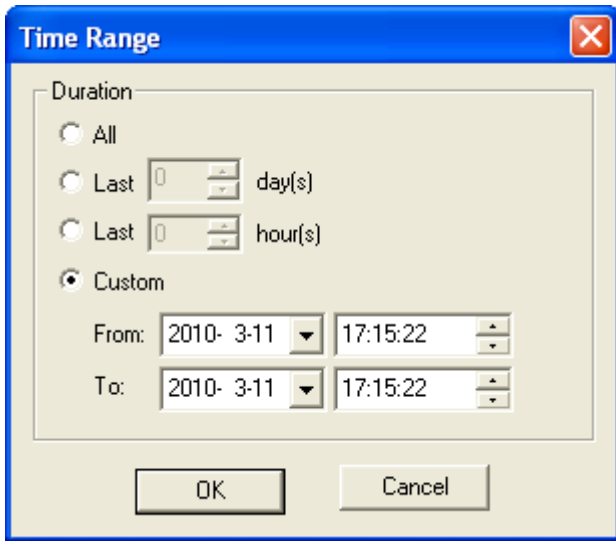

The following table describes each property in the Time Range dialog.

Property	Description
All	Select this option to get all the data from the associated memory.
Last day(s)	Select this option to get the data during the last number of days. If you want to include today, check the Include today option.
Last hour(s)	Select this option to get the data during the last number of hours. If you want to include the current hour, check the Include current hour option.
Custom	Select this option to customize the duration. You need to specify the start date and time and the end date and time

18.3. TextEditor

18.3.1. Exporting Text

You can export texts from the current panel application to a panel text file (PTX). The PTX file can be opened and edited in the TextEditor. For more about the TextEditor, please see details in [Section 18.3.3](#).

To export texts of the panel application, click Tools to bring up the Tools sub-menu from the menu bar. And then click Export Text... in the Tools sub-menu.

The following is an example of the Export Text dialog.

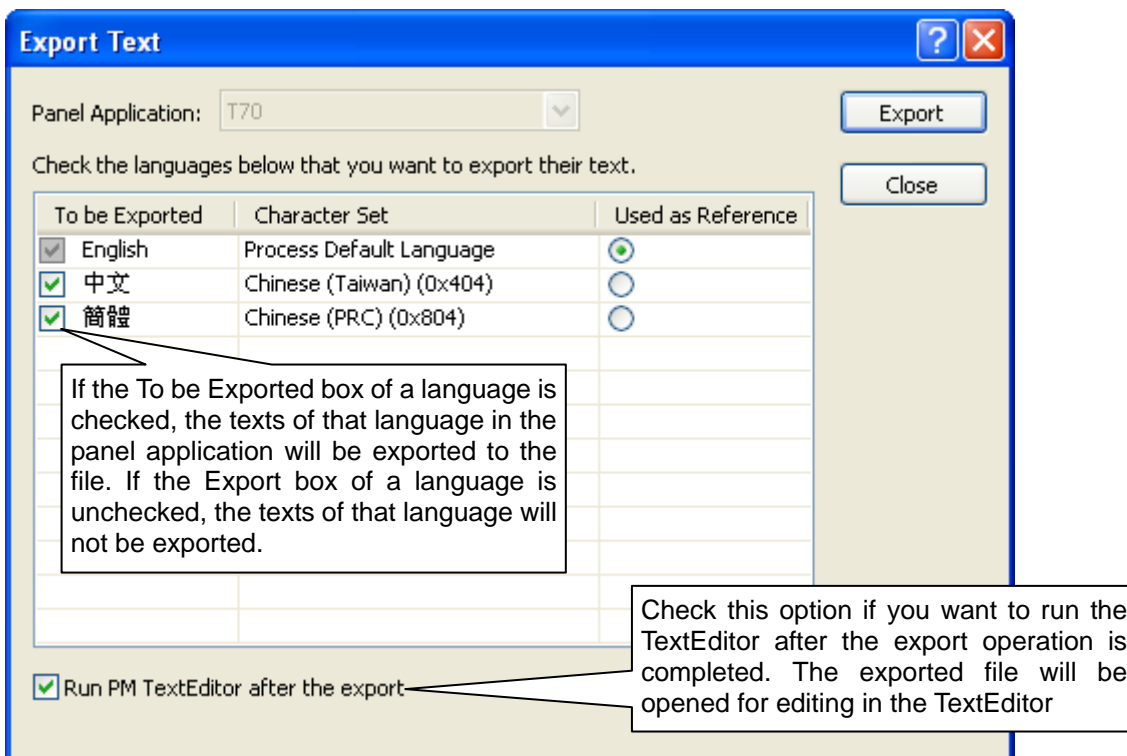

Note: If the application only uses a single language, the export text operation will be invalid.

18.3.2. Importing Text

You can import or export texts from a panel text file (PTX) to the selected panel application.

To import texts to the panel application, click Tools to bring up the Tools sub-menu in the menu bar. Then, click Import Text...in the Tools sub-menu.

The following is an example of the Import Text dialog.

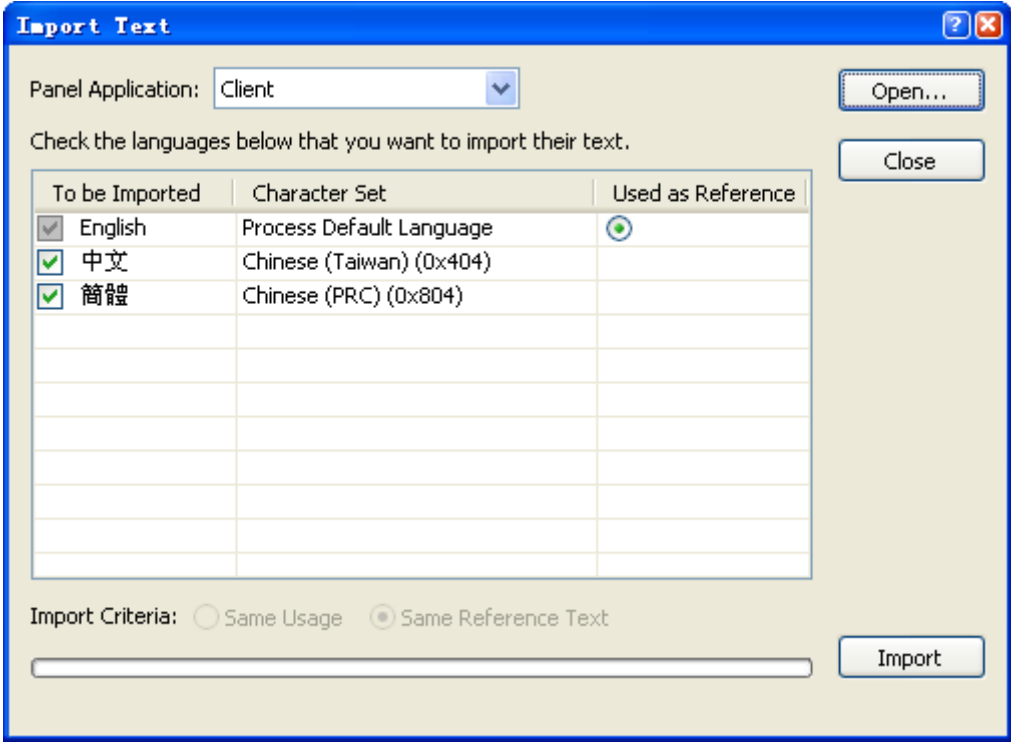

The following table describes each property in the Import Text dialog.

Property	Description
Panel Application	Select a panel application where you want to save the imported texts.
To be Imported	Check the languages of the text you want to be imported.
Open...	Click the button to open the PTX file. Note: The panel application must contain the same language name as the reference language name specified in the imported PTX file. Otherwise, the file is not allowed to be imported.
Close	Close the dialog.
Import Criteria	Select the Same Usage option to import texts to the destination with the same usage as the source in the file. Select the Same Reference Text option to import texts to the destination with the same reference text.
Import	Click the button to import all the selected texts.

18.3.3. TextEditor

TextEditor is an independent executable program. It is used to edit all the screen texts in multi-languages

To run TextEditor, choose Start > All Programs > "The software" >  TextEditor. Alternatively, click Tools to bring up the Tools sub-menu from the menu bar. Then, click TextEditor in the Tools sub-menu.

The following is an example of the TextEditor:

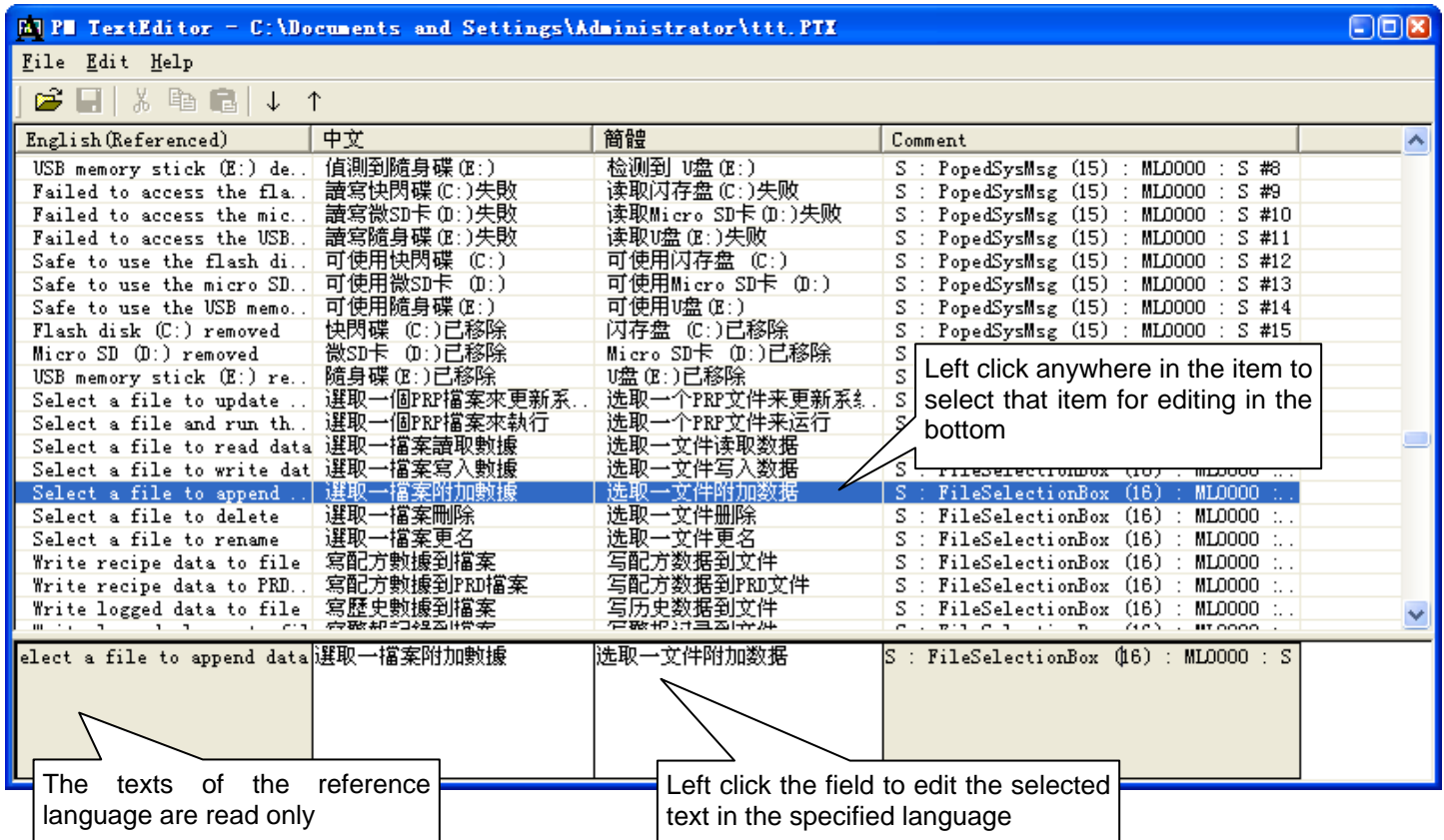







English (Referenced)	中文	簡體	Comment
USB memory stick (E:) de...	偵測到隨身碟 (E:)	检测到 U盘 (E:)	S : PopedSysMsg (15) : ML0000 : S #8
Failed to access the fla...	讀寫快閃碟 (C:)失敗	读取闪存盘 (C:)失败	S : PopedSysMsg (15) : ML0000 : S #9
Failed to access the mic...	讀寫微SD卡 (D:)失敗	读取Micro SD卡 (D:)失败	S : PopedSysMsg (15) : ML0000 : S #10
Failed to access the USB...	讀寫隨身碟 (E:)失敗	读取U盘 (E:)失败	S : PopedSysMsg (15) : ML0000 : S #11
Safe to use the flash di...	可使用快閃碟 (C:)	可使用闪存盘 (C:)	S : PopedSysMsg (15) : ML0000 : S #12
Safe to use the micro SD...	可使用微SD卡 (D:)	可使用Micro SD卡 (D:)	S : PopedSysMsg (15) : ML0000 : S #13
Safe to use the USB memo...	可使用隨身碟 (E:)	可使用U盘 (E:)	S : PopedSysMsg (15) : ML0000 : S #14
Flash disk (C:) removed	快閃碟 (C:)已移除	闪存盘 (C:)已移除	S : PopedSysMsg (15) : ML0000 : S #15
Micro SD (D:) removed	微SD卡 (D:)已移除	Micro SD卡 (D:)已移除	S
USB memory stick (E:) re...	隨身碟 (E:)已移除	U盘 (E:)已移除	S
Select a file to update ..	選取一個PRP檔案來更新系...	选取一个PRP文件来更新系...	S
Select a file and run th...	選取一個PRP檔案來執行	选取一个PRP文件来运行	S
Select a file to read data	選取一檔案讀取數據	选取一文件读取数据	S
Select a file to write dat	選取一檔案寫入數據	选取一文件写入数据	S
Select a file to append ..	選取一檔案附加數據	选取一文件附加数据	S : FileSelectionBox (16) : ML0000 ...
Select a file to delete	選取一檔案刪除	选取一文件删除	S : FileSelectionBox (16) : ML0000 ...
Select a file to rename	選取一檔案更名	选取一文件更名	S : FileSelectionBox (16) : ML0000 ...
Write recipe data to file	寫配方數據到檔案	写配方数据到文件	S : FileSelectionBox (16) : ML0000 ...
Write recipe data to PRD...	寫配方數據到PRD檔案	写配方数据到PRD文件	S : FileSelectionBox (16) : ML0000 ...
Write logged data to file	寫歷史數據到檔案	写历史数据到文件	S : FileSelectionBox (16) : ML0000 ...
...

The texts of the reference language are read only

Left click the field to edit the selected text in the specified language

Left click anywhere in the item to select that item for editing in the bottom

The following table lists all the buttons on the toolbar.

Icon	Tool Tip	Description
	Open	Open the PTX file which saved all the screen texts in multi-language. You can create the PTX file by using Export Text Tool provided by the software. Please see details about Export Text in Section 18.3.1 .
	Save	Save the current PTX file.
	Cut	Cut the selection and put it on the Clipboard.
	Copy	Copy the selection and put it on the Clipboard.
	Paste	Place the Clipboard contents on to the current screen.
	Alt+Dn	Move the selection down from the previous item
	Alt+Up	Move the selection up from the next item

18.4. Recipe Editor

Recipe Editor is an independent executable program. It can be used to view and edit recipe data saved as a PRD file on the PC.

To run the Recipe Editor, choose Start > All Programs > "The software" >  RecipeEditor.

You can display the recipe data row-wise or column wise.

The following is an example of RecipeEditor displayed row-wise. You can click the  button on the toolbar or use the Row-wise command in the View menu. Row-wise means that the recipe number is used to index the row.

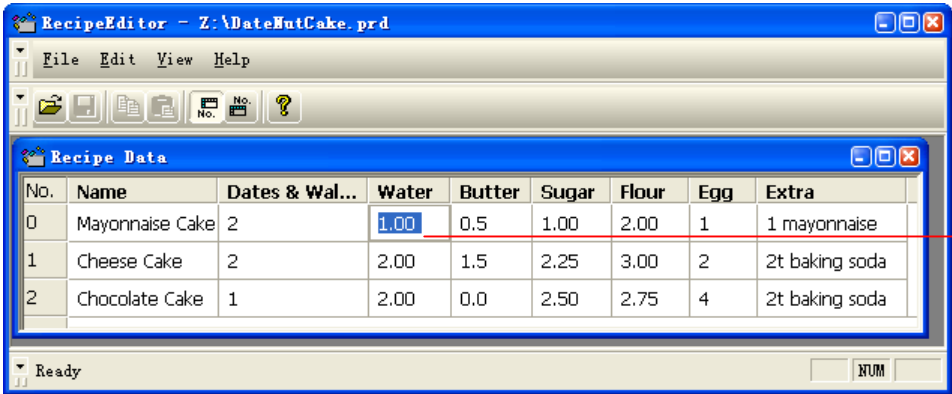

►► To edit the recipe data, left click the cell and key in the value you want.

Note that any value unmatched with the predefined format will cause an error when using the recipe at the runtime.

The following is an example of the RecipeEditor displayed column-wise. You can click the  button on the toolbar or use the Column-wise command in the View menu. Column-wise means that the recipe number is used to index the column.

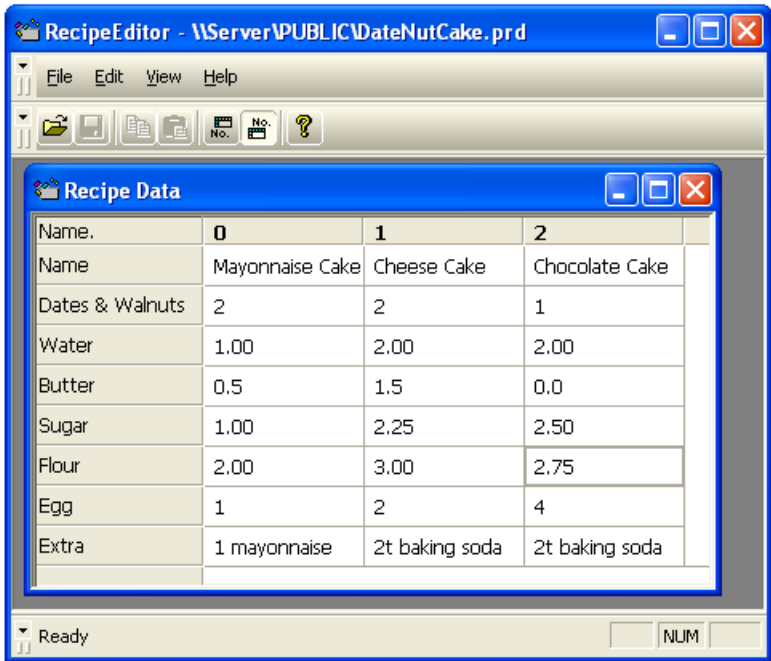

CHAPTER 19

SETTING UP TARGET PANEL

19.1. System Screens	1
19.1.1. Numeric Keypad.....	1
19.1.2. Character Keypad.....	2
19.1.3. Password Keypad.....	3
19.1.4. Password Table.....	3
19.1.5. Select File.....	4
19.1.6. Rename.....	5
19.2. Panel Setup	6
19.2.1. Entering Panel Setup Mode.....	8
19.2.2. General Settings.....	8
19.2.3. Calibrating the Touch Panel.....	10
19.2.4. Time and Date Settings.....	11
19.2.5. Link Settings (Serial Port).....	12
19.2.6. Link Settings (Ethernet Port).....	13
19.2.7. LAN Printer Address.....	14
19.2.8. FTP Site.....	15
19.3. Recovering System by System Loader	16

19.1. System Screens

System screens are screens that are built into an application and can be accessed by end-users in the target panel. System screens are window screens. Each of them has a title bar at the top of the screen that displays a line of text. The text indicates the purpose of the screen. You can press the title bar and hold it down to move the screen to the position you want and then release the pressing to locate the screen.

The system screens include:

- Built-in keypads that are used to input numbers, ASCII characters, or passwords.
- The Select File Window and Rename window are used for file operations.

With built-in keypads, you don't have to spend any time on programming them.

19.1.1. Numeric Keypad

The target panel displays the numeric keypad to let you enter a value when you press and release the Numeric Entry object, Word Button object, and Recipe Table object. The following are examples of Numeric Keypads:

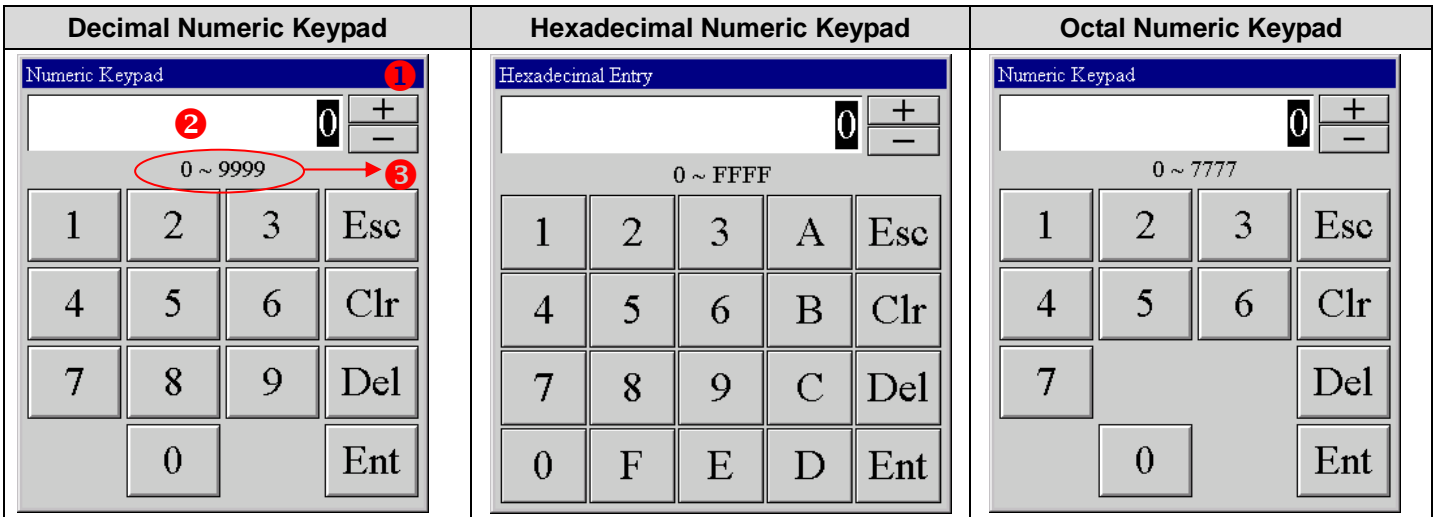

The following table describes each item on the keypad screen.

Item	Description	
① Title Bar	Press and hold the title bar to move the window screen.	
② Keypad Display	Display the current input value	
③ Allowable input range display	Display the allowable input range	
Buttons	+	Press the button to increase the value by 1
	-	Press the button to decrease the value by 1
	0 - 7	Press the number buttons of the Octal Numeric Keypad to enter a number from 0 to 7
	0 - 9	Press the number buttons of the Decimal Numeric Keypad to enter a number from 0 to 9
	0 - F	Press the number buttons of the Hexadecimal Numeric Keypad to enter a number from 0 to F
	Esc	Press it to close the screen and discard all changes.
	Clr	Press it to clear the input value.
	Del	Press it to delete the preceding character.
Ent	Press it to close the screen and accept all changes.	

19.1.2. Character Keypad

The target panel displays the ASCII Character keypad to let you enter an ASCII character when you press and release the Character Entry object. The following is an example of the Character Keypad.

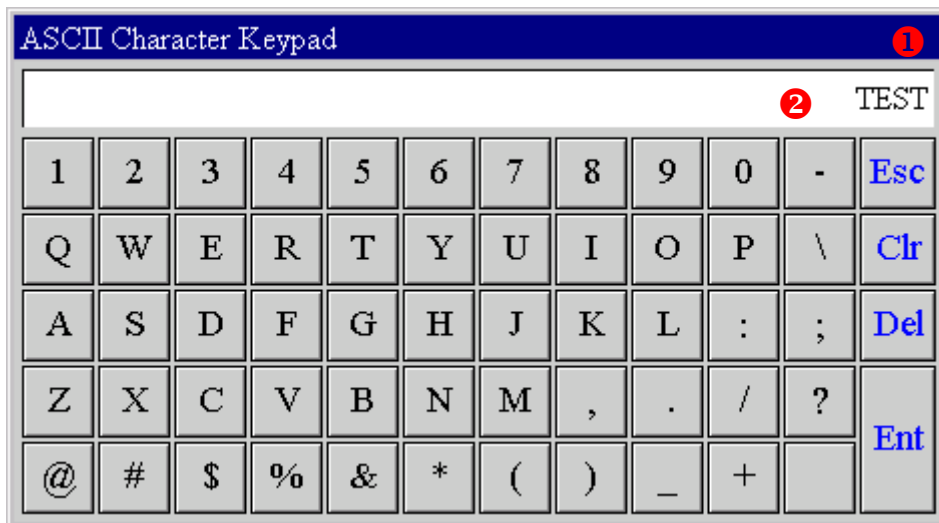

The following table describes each item on the keypad screen.

Item		Description
① Title Bar		Press and hold the title bar to move the window screen.
② Keypad Display		Display the current input string
Buttons	ASCII Characters	Press the button to enter an ASCII character.
	Esc	Press it to close the screen and discard all changes.
	Clr	Press it to clear the input value.
	Del	Press it to delete the preceding character.
	Ent	Press it to close the screen and accept all changes.

19.1.3. Password Keypad

The following is an example of the Password Keypad.

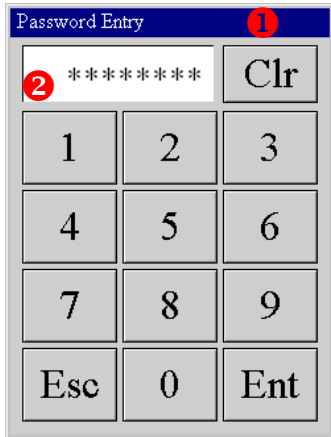

The following table describes each item on the Password Keypad.

Item		Description
① Title Bar		Press the title bar and hold to move the window screen.
② Password Display		Display the current input password
Buttons	0 - 9	Press the number buttons to enter a number from 0 to 9. It will display asterisks (*) instead of the number.
	Esc	Press it to close the screen and discard all changes.
	Clr	Press it to clear the input password.
	Ent	Press it to close the screen and input the password.

19.1.4. Password Table

To register new passwords or modify existing passwords for your application, you have to create a function button on a screen and assign the function “Show Password Table” to the button. When the panel is running the application, a level 8 user can get the password table as shown below when he presses and releases the function button that shows the password table.

Note: The user can only get the passwords whose levels are lower than or equal to the user’s level for editing. For example, if the current user level is 5, the password table will only show the passwords for levels 1 to 5.

The following is an example of the Password Table when the current user level is 8.

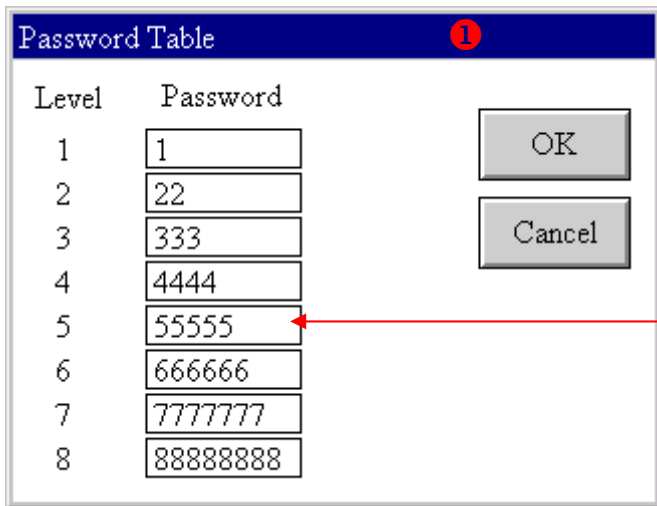

Press here and release to reverse the color of the field and bring out the decimal numeric keypad in order to specify the password for level 5.

The following table describes each item on the keypad screen.

Item	Description
① Title Bar	Press and hold the title bar to move the window screen.
Password	Press the field to bring out the decimal numeric keypad to specify the password for the corresponding user level. A password is a positive integer of up to 8 digits. A password must be unique within the application.
OK	Press it to close the dialog box and accepts all changes.
Cancel	Press it to close the dialog box and discard all changes.

19.1.5. Select File

The Select File screen is only for the panels that support file operations. It allows the user to select a file from the system for the following operations:

No.	Operations	No.	Operations
1	Select a file to update the OS & AP	15	Read recipe data from TXT file
2	Select a file and run the OS & AP in it	16	Read recipe data from DAT file
3	Select a file to read data	17	Write OS and AP to file
4	Select a file to write data	18	Print screen to file (256 colors)
5	Select a file to append data	19	Print screen to file (64K colors)
6	Select a file to delete	20	Write logged data to .LDF file
7	Select a file to rename	21	Read logged data from .LDF file
8	Write recipe data to TXT file	22	Write line chart data to file
9	Write recipe data to DAT file	23	Read line chart data from file
10	Write logged data to file	24	Write scatter chart data to file
11	Write logged alarms to file	25	Read scatter chart data from file
12	Write alarm counts to file	26	Select a file to copy
13	Write logged operations to file	27	Read logged data file from file
14	Write panel data to file		

The following is an example of the Select File screen.

The screenshot shows the 'Select File' dialog box. The title bar is blue and contains the text 'Select File'. Below the title bar is a text field containing 'Select a file and run the OS & AP in it'. Below this is a text field showing the current disk 'C:\'. A list box displays the files '1.PR' and '2.PR', with '1.PR' highlighted. To the right of the list box are 'OK' and 'Cancel' buttons. Below the list box is a text field containing '1'. At the bottom right is a button labeled 'PRP'. Red arrows point from text boxes to these various elements.

Indicates the operation.

Press and hold the title bar to move the window screen.

Displays the current disk.
 "C:\": Indicates the flash disk.
 "D:\": Indicates the micro SD card.
 "E:\": Indicates the USB memory stick.

The list box lists all the existing files on the specified disk. The current file is highlighted. If the desired file is not in view, you can use the scroll bar to scroll to the file. You can select the desired file by touching its name which will be shown in the file name field below.

The file name field displays the name of the selected file. You can press the field to bring out the ASCII characters keypad to specify the file name. The color of the field will be reversed when editing.

The predefined file extension name for the operation.

19.1.6. Rename

The Rename screen is only for panels that support file operations. It allows the user to rename a file in the system.

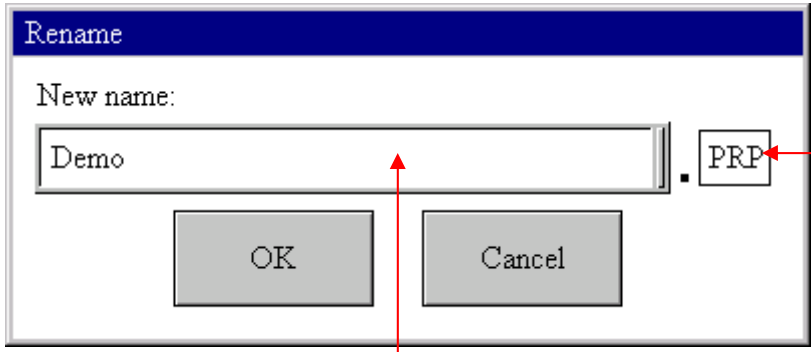

The predefined file extension name.

Press the field to bring out the ASCII characters keypad to specify the new file name. The color of the field will be reversed when editing.

19.2. Panel Setup

After power is applied, the target panel displays the Panel Setup screen. The following is an example of a Panel Setup screen:



Note: Some of the buttons on the Panel Setup screen appear only when they are needed.

Note: After powering up, the target panel will not display the Panel Setup screen if “Run AP After Power On” in General Settings is True. If it is False, the target panel will run the application directly.

The following table describes the function of each button on the Panel Setup screen of the target panel.

Property	Press the button to
English/中文(繁體)/中文(简体)	Display the texts of the screen in the corresponding language.
General	Set the contrast and brightness of the display. Please see Section 19.2.2 for details.
Touch Panel	Calibrate the touch panel. Please see Section 19.2.3 for details.
Set Time/Date	Set the date and time on the Real Time Clock Chip. Please see Section 19.2.4 for details.

Continued

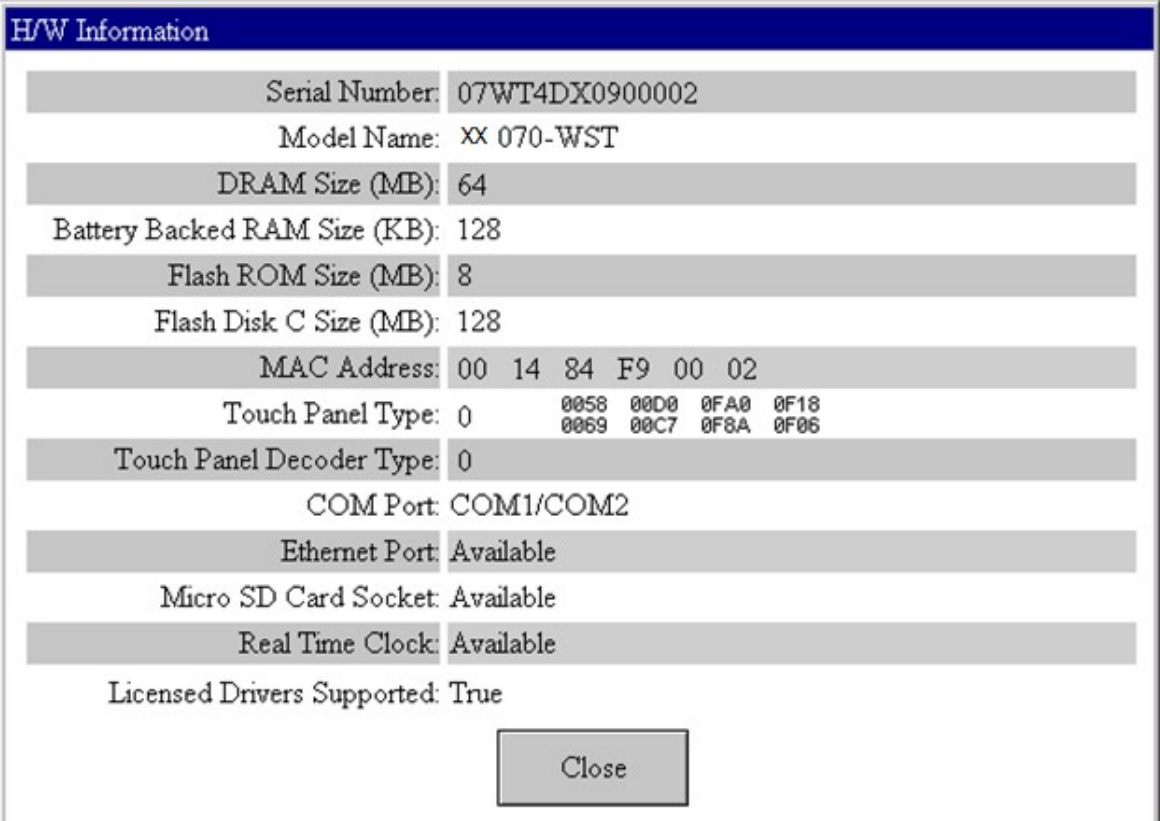
Property	Press the button to
H/W Information	<p>Display the hardware information of the target panel. The following is an example of the hardware information screen</p>  <p>The screenshot shows a window titled 'H/W Information' with the following details:</p> <ul style="list-style-type: none"> Serial Number: 07WT4DX0900002 Model Name: XX 070-WST DRAM Size (MB): 64 Battery Backed RAM Size (KB): 128 Flash ROM Size (MB): 8 Flash Disk C Size (MB): 128 MAC Address: 00 14 84 F9 00 02 Touch Panel Type: 0 (hex: 0058 00D0 0FA0 0F18 0069 00C7 0F8A 0F06) Touch Panel Decoder Type: 0 COM Port: COM1/COM2 Ethernet Port: Available Micro SD Card Socket: Available Real Time Clock: Available Licensed Drivers Supported: True <p>A 'Close' button is located at the bottom center of the window.</p>
Link 1 - Link 4	Set the parameters for communication between the target panel and PLC/Controllers. Please see Section 19.2.5 or Section 19.2.6 for details.
LAN Printer Address	Specify the IP address of the network printer. Please see Section 19.2.7 for details.
Copy AP to HMI	Copy the application to another HMI.
Copy AP to File	Save the system programs and the application runtime data to a PRP file. The file can be used by the software and compatible target panels.
Copy File	Copy the file.
Format Disk C	Format the built-in flash disk (C:). This operation requires a user level of 8 or higher.
FTP Site	Assign the user name and the permission of the file operations for the target panel as a FTP site. Please see Section 19.2.8 for details.
Boot from File	Load-and-run the system programs and the application runtime data from a PRP file. The original system programs and runtime data are intact. The loaded system programs and the runtime data will be lost after power off.
Update from File	Update the system programs and the application runtime data from a PRP file. The original system programs and the application runtime data are replaced by the new ones.
Clear Recorded Data	Clear the data stored in the battery backed RAM, which include the operation history, alarm history, alarm counts, and the data collected by data loggers. This operation requires a user level of 7 or higher.
Run	Start running the application. If login is required, the operator must enter a valid password of any user level before the target panel displays the first screen. The user level of the password you enter becomes the current user level. Any operation that requires a user level higher than the current user level will not work while the application is running.

19.2.1. Entering Panel Setup Mode

Sometimes, you need to put the target panel into the Panel Setup Mode in order to set it up. These are the steps for you to enter the Panel Setup Mode when an application is running:

Step 1:

Pin-point the upper-left corner of the screen. If successful, there will be a square blinking once on the corner.

Step 2:

Pin-point the upper-right corner of the screen. If successful, there will be a square blinking once on the corner.

Step 3:

Pin-point the upper-left corner of the screen. If successful, there will be a square blinking once on the corner.

Only after pin-pointing the left-right-left corners of the screen successfully, will you be able to get the target panel into the Panel Setup Mode.

Note: If the above procedure does not work, you need to check to see whether the Allow to Run Panel Setup flag under the General Settings screen is True. If it is False, the target panel will not be allowed to run panel setup.

19.2.2. General Settings

You may press the General button on the Panel Setup screen to bring up the General screen. The following is an example of the General screen:

Item	Press the button to
	Move the selection in a 7-6-5-4-3-2-1-7 sequence. The current data entry object is highlighted.
	Move the selection in a 1-2-3-4-5-6-7-1 sequence. The current data entry object is highlighted.
	Adjust the selection or increase the value of the current data entry object.
	Adjust the selection or decrease the value of the current data entry object.

The following table describes each property on the General screen.

Property	Description
Check Battery	Select True if you want the panel to check the battery before running the application. If the battery check failed, the "Battery backed RAM data error! All recorded data are cleared!" error message will be displayed on the screen. The default setting is True.
Screen Saver Time(minutes)	Enter a number between 0 and 60 to specify the time that the panel turns off the back light of the display when the panel has not been touched for the specified amount of time. The unit of time is minutes. This option lengthens the life of the CCFT back light. If you set "Screen saver time" to 0, the panel never turns off the back light.
Allow To Run Panel Setup	Select True if you want to exit the running application and enter the panel setup mode.

Continued

Property		Description
Communications Settings		When downloading an application, select Default to use the same communication parameters as those used when transmitting data. Select Current to use the communication parameters set in the target panel. To set up communication parameters, press the Link button on the Panel Setup screen. Please see Section 19.2.5 or Section 19.2.6 for details.
Start-up Language		When downloading an application, select Default to use the same start-up language as what is used when transmitting data, or select 1 to 10 as the start-up language.
Run AP After Power On		Select True if you want to run the application immediately after powering on. The default setting is False.
Display Upside Down		Select True if you want to display the screen upside down. The default setting is False.
IP Address		Press the edit field and bring up the Numeric keypad to input the IP address. Each IP byte can be a value between 0 and 255.
LCD Brightness	Increase	Click it to increase the LCD brightness.
	Decrease	Click it to decrease the LCD brightness.
	Save	Click it to save the current setting of the LCD brightness.
OK		Click it to close the dialog box and accept all changes.
Cancel		Click it to close the dialog box and discard all changes.

19.2.3. Calibrating the Touch Panel

To calibrate the touch panel, you can press Touch Panel button on the Panel Setup screen. Use the following procedure to pin-point the white dots and ok buttons on the screen with an unsharp pencil.

1. Pin-point the white dot on the upper-left corner of the screen.

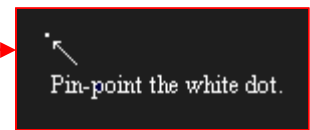
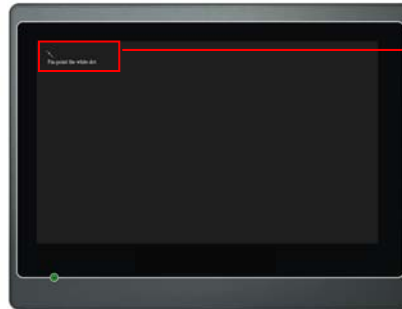

2. Pin-point the white dot on the lower-right corner of the screen.

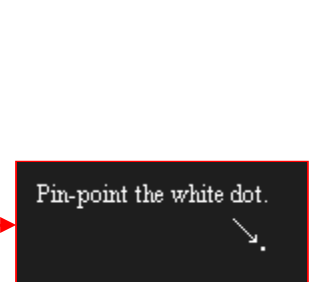
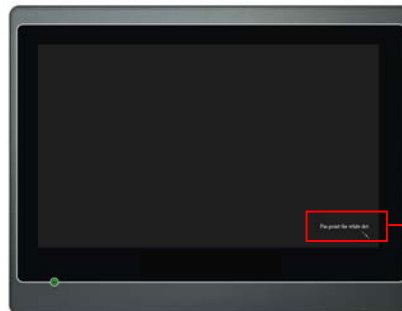

3. You can press the Redo button on the upper-left corner of the screen to go back to step 1.

Alternatively, pin-point the ok button on the lower-left corner of the screen to go to the next step.

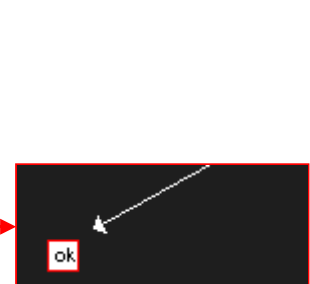
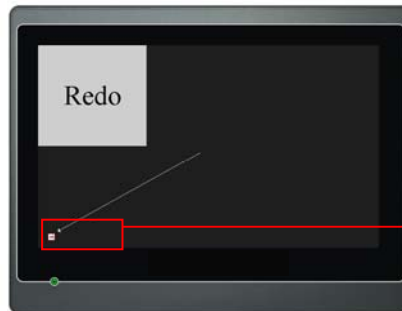

4. You can press the Redo button on the upper-left corner of the screen to go back to step 1.

Alternatively, pin-point the ok button on the upper-right corner of the screen to go to the next step.



5. You can press the Redo button on the upper-left corner of the screen to go back to step 1.

Alternatively, pin-point the ok button at the center of the screen to complete the calibration.

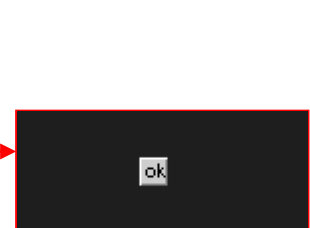
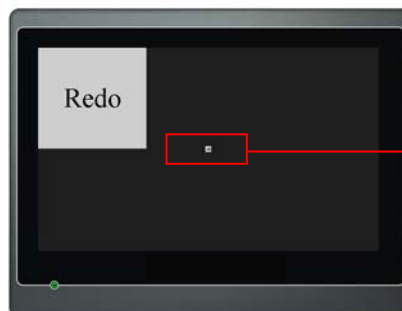

After calibration is completed, the Panel Setup screen displays again.

Note: Do not use anything that is made of metal or is sharp, such as a screw driver or a ball-point pen on the touch panel.

19.2.4. Time and Date Settings

You may press the Set Time/Date button on the Panel Setup screen to bring up the Set Time and Date screen. The following is an example of the Set Time and Date screen.

Item	Press the button to
↑	Move the selection in a 8-7-6-5-4-3-2-1-8 sequence. The current data entry object is highlighted.
↓	Move the selection in a 1-2-3-4-5-6-7-8-1 sequence. The current data entry object is highlighted.
+	Adjust the selection or increase the value of the current data entry object.
-	Adjust the selection or decrease the value of the current data entry object.

The following table describes each property on the General screen.

Property	Description
Current Time (hh:m:ss)	Displays the current time in the Real Time Clock chip.
Current Date (yy/mm/dd)	Displays the current date in the Real Time Clock chip.
Current Day of Week	Displays the current day of week in the Real Time Clock chip.
Hour	Select an integer value from 0 through 23 representing the hour of the day.
Minute	Select an integer value from 0 through 59 representing the minute.
Second	Select an integer value from 0 through 59 representing the second.
Year	Select an integer value from 0 through 99 representing the year.
Month	Select an integer value from 1 through 12 representing the month of the year.
Day	Select an integer value from 1 through 31 representing the day of the month.
Day of Week	Select Mon, Tue, Wed, Thu, Fri, Sat or Sun representing the day of the week.
RTC Adjustment (sec./day)	Set the adjustment in seconds per day to correct the Real Time Clock (RTC).
Set	Save all the changes you made
Set & Exit	Click it to close the dialog box and accept all changes.
Cancel	Click it to close the dialog box and discard all changes.

19.2.5. Link Settings (Serial Port)

This section describes how to set up the communication parameters for the serial communication links using the link screen in the target panel. The default setting of the link screen is transmitted to the target panel along with all the other data when you download an application.

You can press the corresponding Link button on the Panel Setup screen to bring out the link screen. If the link is a serial link, the target panel will display the serial port parameters screen. The following is an example:

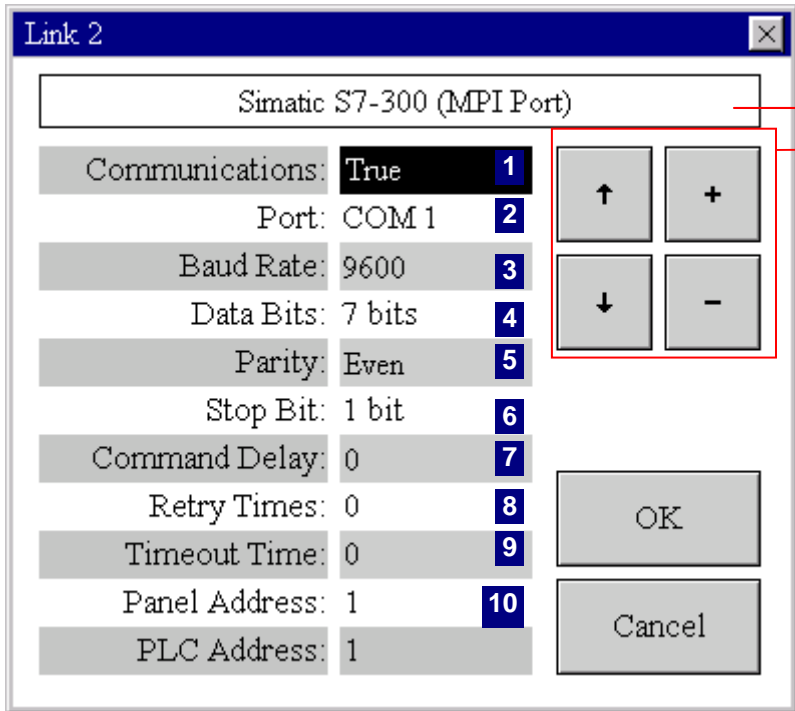

Link 2

Simatic S7-300 (MPI Port)

Communications: True 1

Port: COM 1 2

Baud Rate: 9600 3

Data Bits: 7 bits 4

Parity: Even 5

Stop Bit: 1 bit 6

Command Delay: 0 7

Retry Times: 0 8

Timeout Time: 0 9

Panel Address: 1 10

PLC Address: 1

OK

Cancel

Displays the connected device of this link.

Item	Press the button to
↑	Move the selection in a 10-9-8-7-6-5-4-3-2-1-10 sequence. The current data entry object is highlighted.
↓	Move the selection in a 1-2-3-4-5-6-7-8-9-10-1 sequence. The current data entry object is highlighted.
+	Adjust the selection or increase the value of the current data entry object.
-	Adjust the selection or decrease the value of the current data entry object.

The screen for a serial link appears with the following options:

Property	Description
Communications	Select False if you want to disable the communication between the target panel and the controller. When communication is disabled, the target panel doesn't communication with the controller but can still display screens.
Port	Select either COM1 or COM2 or COM3 to specify the serial port of the target panel that is connected to the controller. The default setting is COM2.
Baud Rate	The baud rate used.
Data Bits	The number of data bits used.
Parity	The scheme of parity used.
Stop Bits	The number of stop bits used.
Command Delay	If the Command Delay is 0, the communication driver sends the next request immediately to the connected device after it received the reply of the last request. If the Command Delay is nonzero, the communication driver delays for the specified amount of time before sending the next request to the connected device.
Retry Count	The number of times that the communication driver will retry to get a successful reply from the connected device for each request. If the number is zero, the communication driver will use a default retry count.
Timeout Time	The maximum time allowed for the communication driver to wait for the reply from the connected device. When the elapsed time exceeds the Timeout Time, the communication driver assumes that the communication failed.
Panel Address	The address of the target panel.
PLC Address	The address of the connected device.

19.2.6. Link Settings (Ethernet Port)

This section describes how to set up the communication parameters for the Ethernet communication links using the link screen of the target panel. The default setting of the link screen is transmitted to the target panel along with other data when you download an application.

You can press the corresponding Link button on the Panel Setup screen to bring out the link screen. If the link is an Ethernet link, the target panel will display the Ethernet parameters screen. The following is an example:

Displays the connected device of this link.

Item	Press the button to
↑	Move the selection in a 4-3-2-1-4 sequence. The current data entry object is highlighted.
↓	Move the selection in a 1-2-3-4-1 sequence. The current data entry object is highlighted.
+	Adjust the selection or increase the value of the current data entry object.
-	Adjust the selection or decrease the value of the current data entry object.

The screen for an Ethernet link appears with the following options:

Property	Description
Communications	Select False if you want to disable the communication between the target panel and the controller. When communication is disabled, the target panel doesn't communication with the controller but can still display screens.
Command Delay	If the Command Delay is 0, the communication driver immediately sends the next request to the connected device after it received a reply from the last request. If the Command Delay is nonzero, the communication driver delays for a specified amount time before sending the next request to the connected device.
Retry Count	The number of times that the communication driver will retry to get a successful reply from the connected device for each request. If the number is zero, the communication driver will use a default retry count.
Timeout Time	The maximum time allowed for the communication driver to wait for a reply from the connected device. When the elapsed time exceeds the Timeout Time, the communication driver assumes that the communication failed.
Port	Displays the IP port for use
IP Address	Specify the IP address of the connected device. You can press the corresponding field to bring out the Decimal Numeric Keypad to input numbers.
OK	Click it to close the dialog box and accept all changes.
Cancel	Click it to close the dialog box and discard all changes.

19.2.7. LAN Printer Address

To use a LAN printer, you need to assign an IP address and a port for the printer on the target panel. You can press the LAN Printer Address button on the Panel Setup screen to bring out the screen. The following is an example:

The screenshot shows a dialog box titled "LAN Printer Address". It has a white background and a blue title bar. The "IP Address" field is composed of four separate boxes containing the numbers 140, 132, 164, and 72. The "Port" field is a single box containing the number 20660. At the bottom of the dialog are two buttons: "OK" and "Cancel".

The LAN Printer Address screen appears with the following options:

Property	Description
IP Address	Specifies the IP address of the connected network printer. You can press the corresponding field to bring out the Decimal Numeric Keypad to input an integer value from 0 to 255.
Port	Specifies the used IP port. You can press the corresponding field to bring out the Decimal Numeric Keypad to input an integer value from 0 to 65535.
OK	Click it to close the dialog box and accept all changes.
Cancel	Click it to close the dialog box and discard all changes.

19.2.8. FTP Site

To access files in the target panel from a remote site you need to do the following:

- 1) Open Internet Explorer (or any other web browser) and enter the site address. You will need to type ftp:// and then the IP address of the target panel. For example, you can type it as <ftp://192.168.10.163>. To set the IP address of the target panel, please see [Section 19.2.2](#) for details.
- 2) The target panel (FTP site) requires a user name and password to login.
 If the target panel has an application, the user needs to enter a password defined in that application with sufficient user level to enter the FTP site for reading/writing files.
Note: A user that can write files is able to read files too.

If the target panel has no application, the user can remote access the FTP site by using the default password "123".

After you have successfully logged on to the target panel (FTP site), you will see the available files that you have permission to access. It will look very similar to your Windows Explorer or My Computer view. From there, you can read and write files from your local hard drive to the target panel (FTP site) and vice versa. Keep in mind that you will need to have the appropriate permission to perform file operations. These permissions will be assigned to the user account in the target panel (FTP site).

To assign a user name and read/write permissions for the target panel (FTP site), you can press the FTP Site button on the Panel Setup screen to bring out the following sample screen:

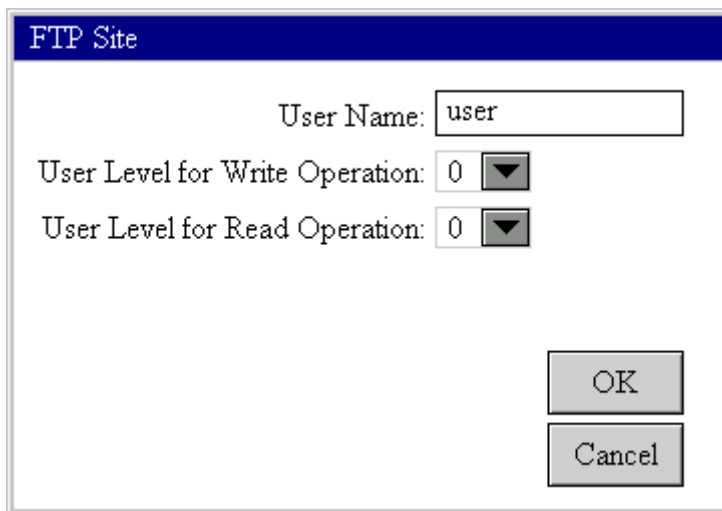

The FTP Site screen appears with the following options:

Property	Description
User Name	Specifies the user name for the target panel. You can press the field to bring up the ASCII Character Keypad to input up to 8 ASCII characters. The default user name is "user".
User Level for Write Operation	Specifies the user level that is required to write files to the target panel.
User Level for Read Operation	Specifies the user level that is required to read files from the FTP site.
OK	Click it to close the dialog box and accept all changes.
Cancel	Click it to close the dialog box and discard all changes.

19.3. Recovering System by System Loader

When there is a system-critical problem that interferes with the normal operation of the target panel, users may need to boot into the system loader mode, which allows them to troubleshoot their target panel or update the application. Once you have corrected the problem, you can reboot and the target panel will run normally.

To get the target panel into the system loader mode, press the upper-left corner for 3 seconds while the power is on, once there is a beeping sound, the System Loader screen will be displayed as shown below:

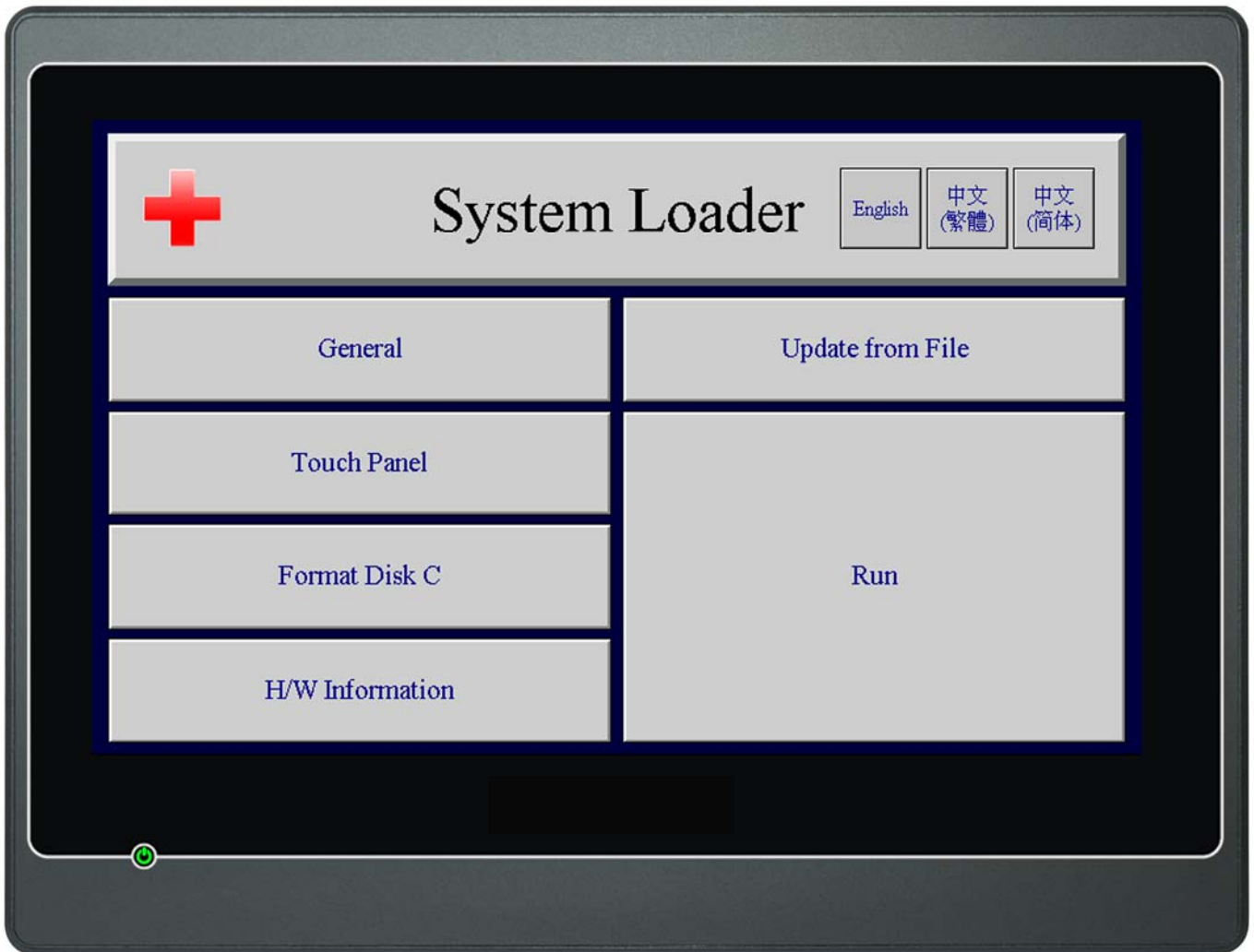

The following table describes the function of each button on the System Loader screen of the target panel.

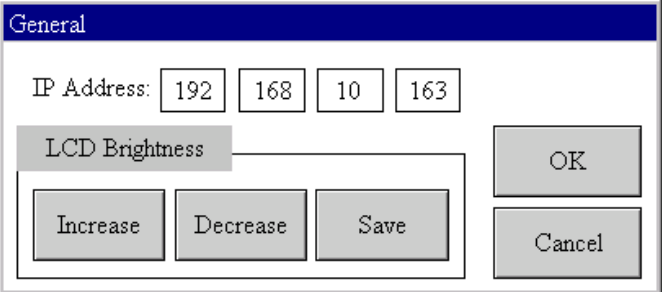
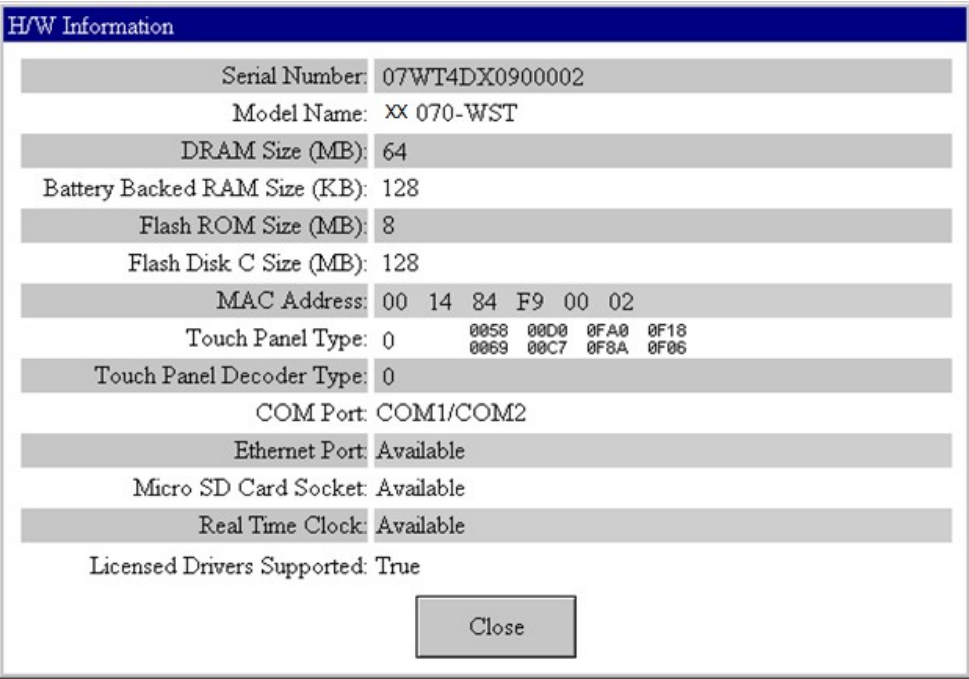
Property	Press the button to															
English/中文(繁體)/中文(简体)	Display the texts of the screen in the corresponding language.															
General	<p>Set the IP address and brightness of the display. The following is an example of the General screen.</p>  <p>The following table describes each property in the General screen.</p> <table border="1"> <thead> <tr> <th>Property</th> <th>Description</th> </tr> </thead> <tbody> <tr> <td>IP Address</td> <td>Press the field and bring up the Numeric keypad to input the IP address. Each IP byte can be the value between 0 and 255.</td> </tr> <tr> <td rowspan="3">LCD Brightness</td> <td>Increase</td> <td>Click it to increase the LCD brightness.</td> </tr> <tr> <td>Decrease</td> <td>Click it to decrease the LCD brightness.</td> </tr> <tr> <td>Save</td> <td>Click it to save the current setting of the LCD brightness.</td> </tr> <tr> <td>OK</td> <td>Click it to close the dialog box and accept all changes.</td> </tr> <tr> <td>Cancel</td> <td>Click it to close the dialog box and discard all changes.</td> </tr> </tbody> </table>	Property	Description	IP Address	Press the field and bring up the Numeric keypad to input the IP address. Each IP byte can be the value between 0 and 255.	LCD Brightness	Increase	Click it to increase the LCD brightness.	Decrease	Click it to decrease the LCD brightness.	Save	Click it to save the current setting of the LCD brightness.	OK	Click it to close the dialog box and accept all changes.	Cancel	Click it to close the dialog box and discard all changes.
Property	Description															
IP Address	Press the field and bring up the Numeric keypad to input the IP address. Each IP byte can be the value between 0 and 255.															
LCD Brightness	Increase	Click it to increase the LCD brightness.														
	Decrease	Click it to decrease the LCD brightness.														
	Save	Click it to save the current setting of the LCD brightness.														
OK	Click it to close the dialog box and accept all changes.															
Cancel	Click it to close the dialog box and discard all changes.															
Touch Panel	Calibrate the touch panel. Please see Section 19.2.3 for details.															
Format Disk C	Format the built-in flash disk (C:). This operation requires a user level of 8 or higher.															
H/W Information	<p>Display the hardware information of the target panel. The following is an example of the hardware information screen:</p> 															
Update from File	Update the system programs and the application runtime data from a PRP file. The original system programs and the application runtime data are replaced by the new ones.															
Run	Get into the Panel Setup mode.															



APPENDIX

I.	The range limitation of the software.....	1
-----------	--	----------

I. The range limitation of the software

(A) The limitation of one project:

No.	Item	Maximum
01	Number of panel applications	128
02	Number of languages	10
03	Number of font templates per language	20

(B) The limitation of one panel application:

No.	Item	Maximum
01	Number of tags	No Limitation
02	Number of macros	No Limitation
03	Number of objects in one screen	No Limitation
04	Number of communication links	4/16
05	Regular user memory (\$U)	131072 words
06	Battery backed user memory (\$N)	131072 words
07	Number of screens	7999
08	Number of passwords	User Password: 8 Developer Password: 1
09	Number of Discrete Alarm Blocks	16
10	Number of Analog Alarm Blocks	16
11	Number of Recipe Blocks	16
12	Recipe Size	4095 words
13	Number of recipes per Recipe Block	65535
14	Number of Data Loggers	16
15	Sample Size (Each Block)	128 words
16	Number of Samples (Each Block)	65535